

WEAPONS ACQUISITION

A Rare Opportunity for Lasting Change

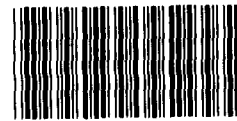
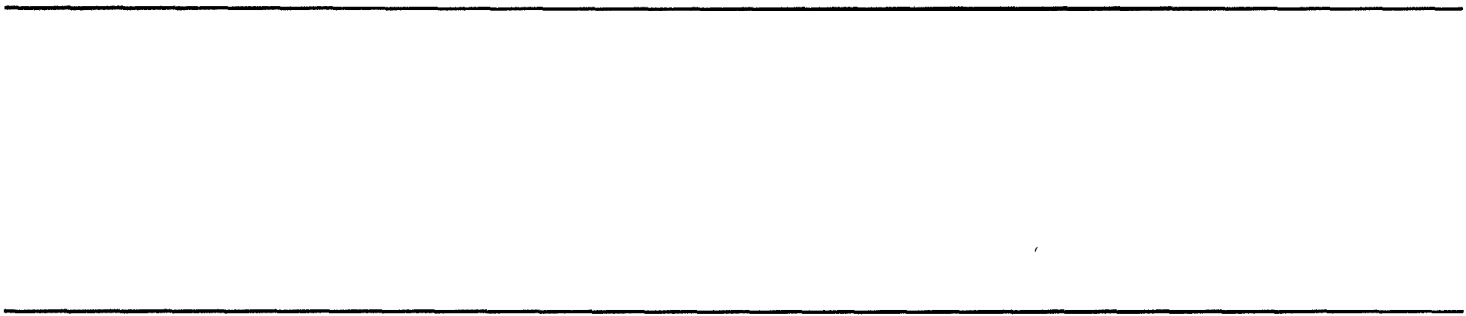

148208

056146/148208



Preface

The United States today is in a position of unprecedented military strength and national security. Its strategic nuclear forces, together with its conventional forces numbering over 400 battle force ships, 5,000 combat aircraft, 10,000 tanks, and numerous other combatant platforms equipped with missiles, bombs, projectiles, and other munitions, are a visible sign of the enormous military power it possesses. While these weapons provide a military capability that no other country is in a position to successfully challenge, their acquisition was, in many cases, fraught with significant problems. Although improvements have been made in the acquisition process over the years, the same kinds of problems can be seen in today's acquisitions.

Why, with an increased emphasis on sound development and testing of weapons, do we still witness major commitments to programs, such as the B-2 bomber and the Airborne Self-Protection Jammer, without first demonstrating the system will meet critical performance requirements? Why, with improved cost-estimating policies and procedures, do we still see the unit costs of weapon systems, such as the DDG-51 destroyer and the C-17 transport, doubling? Why, with the increased emphasis on developing systems that can be efficiently produced and supported, do we have weapons, such as the Advanced Cruise Missile and Apache helicopter, that encounter costly production and support problems?

Clearly, problems are to be expected in major weapon acquisitions, given the technical risks and complexities involved. On the other hand, the historical level of such problems should not be accepted as the norm. As a nation, we can do better. The question is how—what can be done to foster better acquisition outcomes with more success than we have experienced in the past? Today, the prospects for constructive change are quite encouraging. The demise of the Soviet threat and declines in defense budgets have created a unique opportunity to effect lasting changes in weapon acquisitions. Both the Department of Defense and the Congress have acted upon this opportunity and have shown a willingness to support the type of changes needed to improve acquisition outcomes. The current top level management within the Office of the Secretary of Defense has taken steps in an attempt to discipline the acquisition process and to redefine the basic strategy for acquiring weapons. Key Members of Congress have pressed for reevaluations of weapons programs and service roles and functions.

If changes in the acquisition of weapons are to be of a lasting nature, we believe acquisition problems also need to be looked at from another

perspective—as the consequences of a way of acquiring weapons that has become deeply rooted through the years. We refer to this as the “culture,” although this is a somewhat imprecise term. Rather than defining “culture” as mindsets and attitudes, we use the term to describe the collective patterns of behavior exhibited by the numerous participants in the acquisition process and the incentives for that behavior. These participants include the various components of the Department of Defense, the Congress, industry, and critics. By looking at acquisition problems from the perspective of culture, one can gain greater insight into why such problems are resilient—reasons that go beyond technical risks, estimating errors, and shortcomings in oversight.

This culture has evolved as the acquisition process has become a vehicle for meeting the diverse needs of participants through the steady initiation and sustainment of weapon programs. These needs, as translated into weapon systems, transcend the filling of voids in military capability at minimal cost; they involve the definition of roles and missions, the justifications of budget levels and shares, service reputations, organizational influence, the industrial base, jobs, and careers.

Individually, participants act rationally, for they see their needs as aligned with the national interests. However, collectively, these needs create an environment that encourages “selling” programs, along with undue optimism, parochialism, and other compromises of good judgment. For example, is it reasonable to expect program sponsors to present objective risk assessments, report realistic cost estimates, or perform thorough tests of prototypes when such measures expose programs to disruption, deferral, or even cancellation? Because it is not reasonable to do so, a level of cost growth, performance problems, schedule delays, and difficulties with production and field support is essentially embedded in acquisition programs from the beginning. In this light, blaming problems on weapons program managers or any other single participant overlooks the point that these problems are the collective responsibility of all participants.

This report reflects on the major acquisition issues addressed in our work over the past 15 years. Upon taking note of the similarity of the issues during those years, the report explores the cultural side of acquisition problems to suggest ways to ameliorate such problems in the future. These suggestions are outlined in chapter 5. This report is not presented as the singular correct view of the issues discussed; nor does it attempt to cover all acquisition problems. However, it does contend that making

fundamental improvements in acquisitions will require attacking the cultural dimension of the “problem.”

Changes of the type needed will not come easily. They must be directed at the system of incentives that has become self-sustaining and very difficult to uproot. The incentives that motivate the participants must be realigned with better program outcomes. If we expect program sponsors, for example, to be forthright about program alternatives, costs, and risks, such candor must be rewarded, and parochialism and undue optimism penalized. Ultimately, change will occur only through the collective action of acquisition participants, particularly within the Department of Defense and the Congress, for it is their actions that dictate the incentives that drive the process. It is our hope that this report will help to illuminate the cultural changes needed to meet the continuous challenge of improving acquisition outcomes.

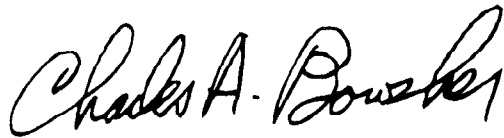

Charles A. Bowsher
Comptroller General
of the United States

Contents

Preface		1
Chapter 1		6
Introduction	Weapon Acquisitions Will Continue to Figure Prominently in Budget and Policy Decisions	6
	GAO Has a Considerable History of Weapon System Evaluations Objectives, Scope, and Methodology	10 13
Chapter 2		15
Weapon Acquisitions Experience a Persistent Set of Problems	Is the System the Best Solution to the Mission Need?	16
	Are the Program Cost and Schedule Estimates Reasonable?	18
	Can the Program Be Executed With Available Funds?	21
	Is the Program's Acquisition Strategy Reasonable?	24
	Has It Been Shown That the System Is Operationally Effective?	28
	Is the System Suitable for Production and Fielding?	30
Chapter 3		35
Persistent Problems May Be the Consequences of the Acquisition Culture	The Acquisition Process Responds to the Needs of Its Participants	35
	Problems Embedded at the Outset of Programs	41
	Incentives for Continuing Programs Grow More Powerful Over Time	45
	Cultural Differences in Successful Programs	49
Chapter 4		51
The Confrontation Between the Acquisition Culture and Reform	Reforms Have Battled the Same Issues for Years	51
	Inability to Change the Culture Has Thwarted Reform	53
	Most Recent Initiatives Offer Promise	58
Chapter 5		59
Opportunities for Change	Are Participants Willing to Make Sacrifices to Achieve Better Outcomes?	60
	Are Participants Willing to Recognize the Broader Consequences of Individual Actions?	61
	Will Participants Agree to a Military Strategy Before Making Major Acquisition Commitments?	62

	Can Incentives Be Changed to Discourage Optimism, Parochialism, and Protectionism?	62
	The Prospects for Change Are Encouraging	67
Appendixes	Appendix I: Examples of Weapon System Acquisition Issues Reported by GAO From January 1978 Through September 1992	70
	Appendix II: Major Contributors to This Report	84
Tables	Table 2.1: Delays in Major Weapon System Programs	20
	Table I.1: Weapon System Programs and Issues	70
Figures	Figure 1.1: Annual Percentage Changes in Total DOD Budget Authority and the Sum of Procurement and RDT&E Accounts	8
	Figure 1.2: Sum of Procurement and RDT&E Accounts as a Percentage of Total DOD Budget Authority	9
	Figure 1.3: DOD's Systems Acquisition Process	12
	Figure 2.1: Insufficient Examination of Alternatives	17
	Figure 2.2: Significant Cost and Schedule Overruns	19
	Figure 2.3: Questionable Affordability	22
	Figure 2.4: Closing the Gap Between DOD's Program and Budget Realities	23
	Figure 2.5: Excessive Concurrency in Acquisition Strategies	26
	Figure 2.6: Major Operational Effectiveness Issues	29
	Figure 2.7: Insufficient Attention to Producibility	31
	Figure 2.8: Operational Support Problems	33
	Figure 3.1: Weapon Acquisition Programs Meet Many Diverse Needs	37
	Figure 3.2: Weapon System Funding Levels and Line Items Over Time	40
	Figure 3.3: U.S. Active, National Guard, and Reserve Attack and Fighter Air Forces	43
	Figure 3.4: Airborne Self-Protection Jammer	48
	Figure 4.1: Key Acquisition Studies and Reform Initiatives	53

Abbreviations

DOD	Department of Defense
GAO	General Accounting Office
RDT&E	Research, Development, Test, and Evaluation

Introduction

Weapon system acquisitions involve highly leveraged decisions with significant consequences for the budget and for national security. A few discrete decisions on weapon systems can commit the nation to spending tens of billions of dollars, can represent national security policy choices, can shape how wars are fought, and can affect the relative roles and functions of the military services. Weapon systems are possibly the most visible symbols of military strength and the reputation of the Department of Defense (DOD). They have come to epitomize both the successes and the failures of the defense establishment.

This study focuses on acquisition problems that have persisted over time. The sweeping changes in national security stemming from the dissolution of the Warsaw Pact and the Soviet Union have fostered a climate conducive to confronting acquisition problems in a fundamental way. We have taken a retrospective look at the hundreds of weapon system reviews we have conducted over the past 15 years to extract lessons learned for future acquisitions. Our focus here is on those cultural or motivational factors that can inhibit the application of sound acquisition practices. Taking a fundamental approach to solving acquisition problems is especially critical as decisions are made on a series of next-generation weapons in the coming years. Experience has shown that many problems originate early in programs and must be confronted when the earliest decisions are made. If a "business as usual" approach is taken, crucial compromises on the defense budget are likely to unravel if key acquisition programs cannot be executed within planned funding levels and time frames.

Weapon Acquisitions Will Continue to Figure Prominently in Budget and Policy Decisions

While DOD has proposed considerable cutbacks in the number and size of its weapons acquisition programs over the next several years, the financial and policy implications of the programs to be pursued will continue to be significant. The discretionary nature of the research and development and procurement accounts makes these segments of the defense budget the subject of intense debate, particularly in times of declining resources. The enormous funding implications of weapons decisions alone command national attention. Even with the reduced threat, DOD has proposed spending about \$100 billion a year on the development and procurement of weapons and related items through the late 1990s. It is no coincidence, therefore, that the administration's 1992 proposals to reduce the defense budget relied heavily on cuts to several major weapons programs—cuts that have since prompted debate and changes within the Congress.

At the highest levels, weapon systems represent fiscal policy choices—in particular, the level of defense spending. Weapon system decisions have taken on added significance as they have come to represent key choices on how to implement a national security strategy that is responsive to the changing world situation. Weapon systems are intertwined with issues such as (1) whether the United States should implement a global defense policy with the Strategic Defense Initiative, (2) how and where the armed forces should be prepared to fight, (3) whether weapon programs should be used as instruments for protecting the industrial base and jobs, (4) whether DOD should adopt an acquisition strategy of carrying new weapons only to the prototype stage rather than to production, and (5) whether modification programs should be emphasized over new weapons. As the administration and the Congress consider these issues, it is clear that decisions on an individual weapon system mean much more than simply buying a piece of equipment.

Acquisition Funds Are Among the Most Discretionary in the DOD Budget

Weapon systems will continue to be debated as difficult decisions are made on how to accommodate declining defense budgets. In the DOD budget, the Procurement and Research, Development, Test and Evaluation (RDT&E) accounts—from which acquisitions are funded—are the most discretionary; when there are changes in defense spending, these accounts generally reflect those changes the most. Figure 1.1 illustrates the pattern of these changes.

Figure 1.1: Annual Percentage Changes in Total DOD Budget Authority and the Sum of Procurement and RDT&E Accounts

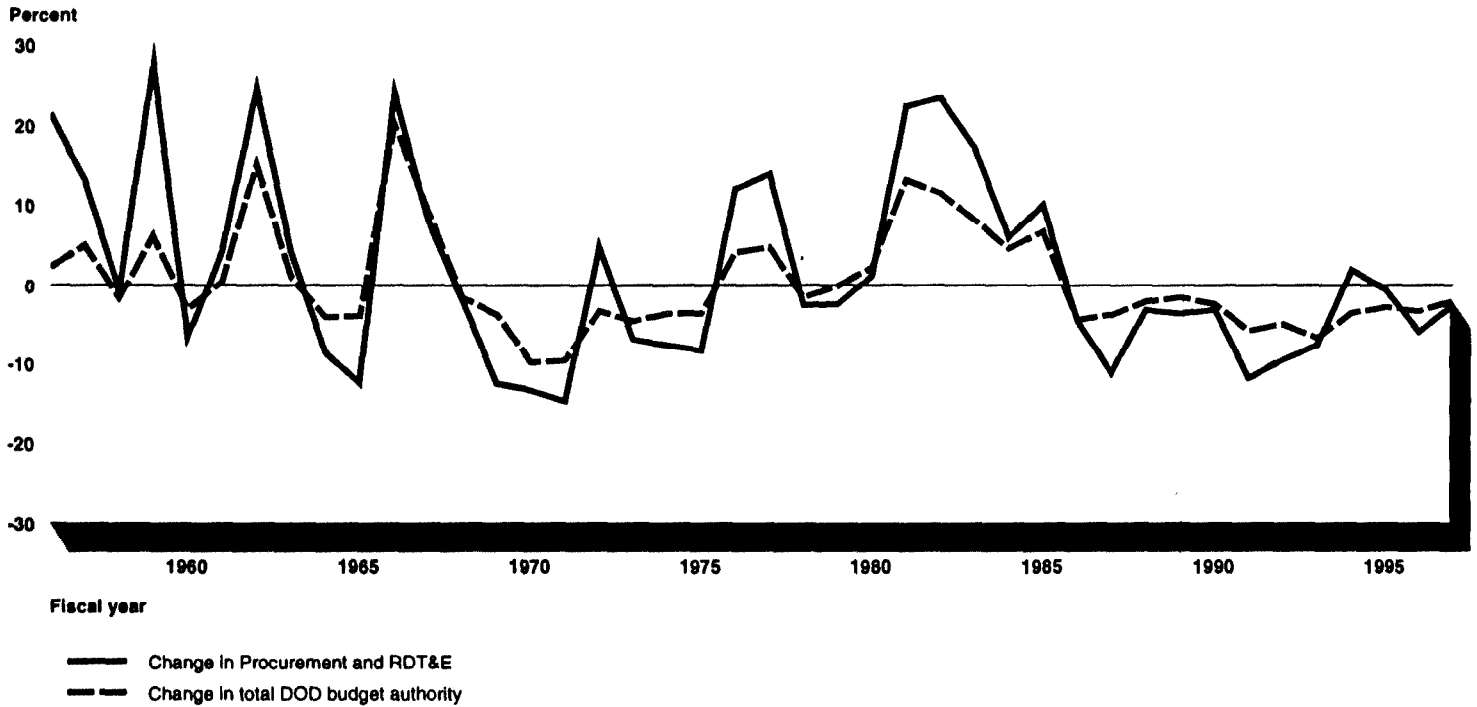

Notes: Amounts are standardized as constant fiscal year 1992 dollars. Data for fiscal years 1992 through 1997 are estimates.

Source: GAO analysis of DOD budget data.

A statistical relationship exists between changes in the combined Procurement and RDT&E accounts and changes in the total DOD budget. Fluctuations in the combined Procurement and RDT&E accounts are matched by similar, less drastic changes in the total DOD budget. Other large accounts, such as Personnel and Operations and Maintenance, have not been as volatile; they are largely determined by previous decisions on force structure and size and on current weapon inventories.

Decisions on Weapon System Acquisitions Affect a Significant Portion of the Total DOD Budget

Procurement and RDT&E make up a significant portion of the total DOD budget and will likely continue to do so in the future. Between fiscal years 1956 and 1991, these accounts represented an average of 37.6 percent of the total DOD budget. However, as illustrated in figure 1.2, that portion of the total DOD budget encompassed by Procurement and RDT&E has not been a constant; it has fluctuated over time from about 30 to nearly 45 percent.

Figure 1.2: Sum of Procurement and RDT&E Accounts as a Percentage of Total DOD Budget Authority

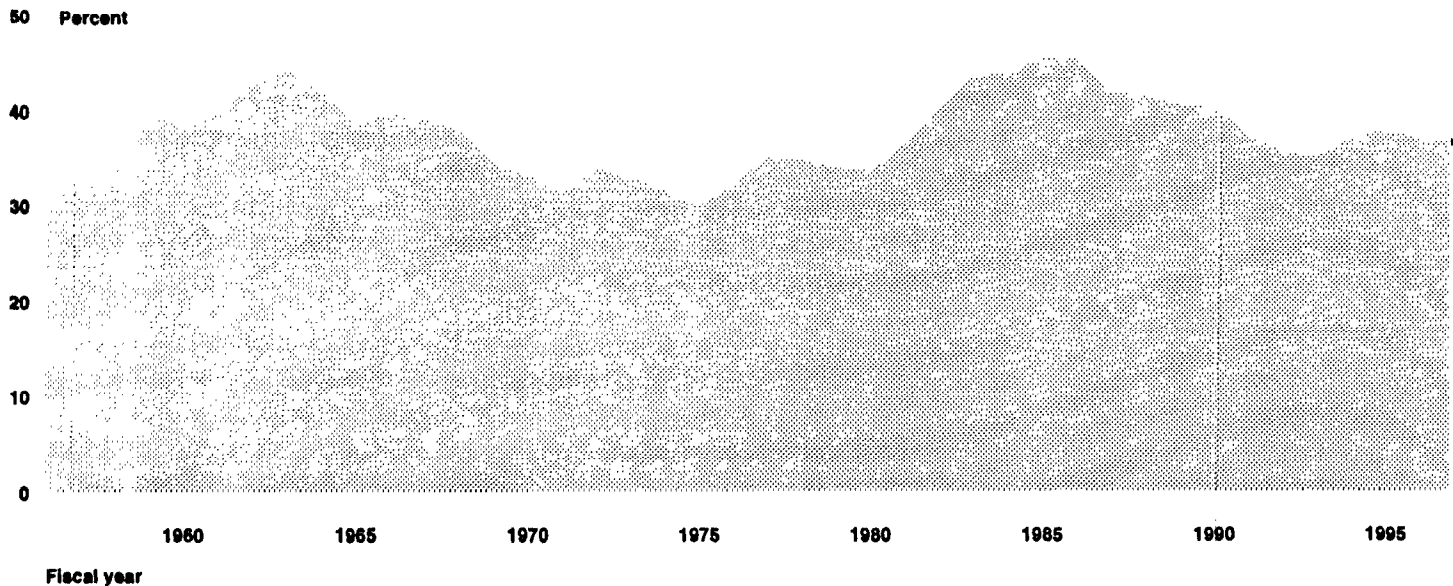

Notes: Amounts are standardized as constant fiscal year 1992 dollars. Data for fiscal years 1992 through 1997 are estimates.

Source: GAO analysis of DOD budget data.

There have been two major high points in budget authority, or “bow waves,” occurring during the earlier stages of the war in Vietnam and the defense buildup of the 1980s. During these two waves, the United States procured previous generations of major weapon systems. Whether another such “bow wave” will take place with the next generation of weapon

systems in the late 1990s and early 2000s depends on funding decisions to be made over the next several years.

Decisions on Weapon Systems Represent Choices About Policy, Strategy, and Roles

The acquisition of weapon systems or types of systems not only obligates large amounts of funding, but represents defense policy decisions. Weapons research and acquisitions can shape military strategy and can influence the roles and functions of the individual military services and weapon systems. For example,

- procuring Pershing II and ground-launched cruise missiles demonstrated an increased commitment to the forward deployment of intermediate-range nuclear weapons in Western Europe;
- the Strategic Defense Initiative's first proposed deployment, to counter a massive Soviet attack with space-based weaponry, represented a new strategy for the deterrence of nuclear war; and
- a commitment to buy heavy tanks can also be a commitment to forward deployment and prepositioning, whereas the purchase of light vehicles suggests a commitment to rapid deployment.

In addition, DOD's decision to develop a higher yield warhead for the Trident submarine-launched ballistic missile expanded the weapon's role. The more lethal warhead, together with significant improvements in missile accuracy, broadened the strategic role of the Navy and its Trident submarine force from one suitable only for nonhardened military and urban industrial targets to one capable of destroying hardened targets such as missile silos and underground command and control centers. Similarly, the role of the manned penetrating strategic bomber was threatened in 1977, when the President terminated production of the B-1A bomber in favor of accelerated development and deployment of the Air-Launched Cruise Missile.

GAO Has a Considerable History of Weapon System Evaluations

GAO has been involved in the evaluation of weapon systems and the acquisition process for over 30 years. During the late 1960s, we began to place more emphasis on reviews of major weapon systems. In February 1970, our first report on the status of 57 major DOD acquisition programs then in development or procurement was issued.¹ In March 1971, we issued our first report on the DOD acquisition process itself, responding to Congress' desire for complete and impartial information about major

¹Status of the Acquisition of Selected Major Weapon Systems (B-163058, Feb. 6, 1970).

weapon systems to facilitate critical acquisition decisions.² This report presented the rationale for performing such evaluations—a rationale that remains pertinent today:

The large investment required in recent years for acquisition of major weapons has impacted heavily on the resources available for other national goals and priorities. Acquiring these major weapons involves substantial long-range commitment of future expenditures. Because of deep concern in the Congress on these matters and because of evidence that the weapon systems acquisition process has serious weaknesses, the General Accounting Office (GAO) has undertaken to provide the Congress and the Department of Defense (DOD) with a continuing series of appraisals of those factors most closely related to effective performance in procuring major weapons.

Since that time, our audits have resulted in over 900 reports and testimonies on virtually all aspects of weapon system acquisitions. This work has covered weapons in all phases, from concept formulation to readiness in the field, including multiservice programs and joint ventures with foreign countries. It has included evaluations of the acquisition process itself as well as numerous systemic issues, such as threat assessments, cost estimating, competition, test and evaluation, personnel practices, logistics management, producibility, acquisition strategies, contracting, budgeting, and programming. It was because of this experience that in November 1988, we advised the new administration and the Congress on what we saw as the critical issues facing the management of defense programs, along with recommended actions to correct problems.³ In this study, we again draw upon our acquisition experience to advise congressional and executive policymakers as they make the decisions that will reshape the nation's defense posture.

Our approach to evaluating defense acquisitions generally involves assessing program results against the criteria embodied in law, DOD regulations, and individual program requirements such as design specifications. In essence, we hold programs to DOD's own criteria, except when criteria are found wanting. The basic policies and procedures of sound acquisition management are captured in DOD's acquisition regulations and in the Office of Management and Budget's Circular A-109, "Major System Acquisitions." We tailor our reviews of individual weapon systems to the standards applicable to the particular acquisition phase the program is in. These phases, punctuated by key decision or milestone points, are depicted in figure 1.3.

²Acquisition of Major Weapon Systems (B-163058, Mar. 18, 1971).

³Transition Series: Defense Issues (GAO/OCG-89-9TR, Nov. 1988).

Figure 1.3: DOD's Systems Acquisition Process

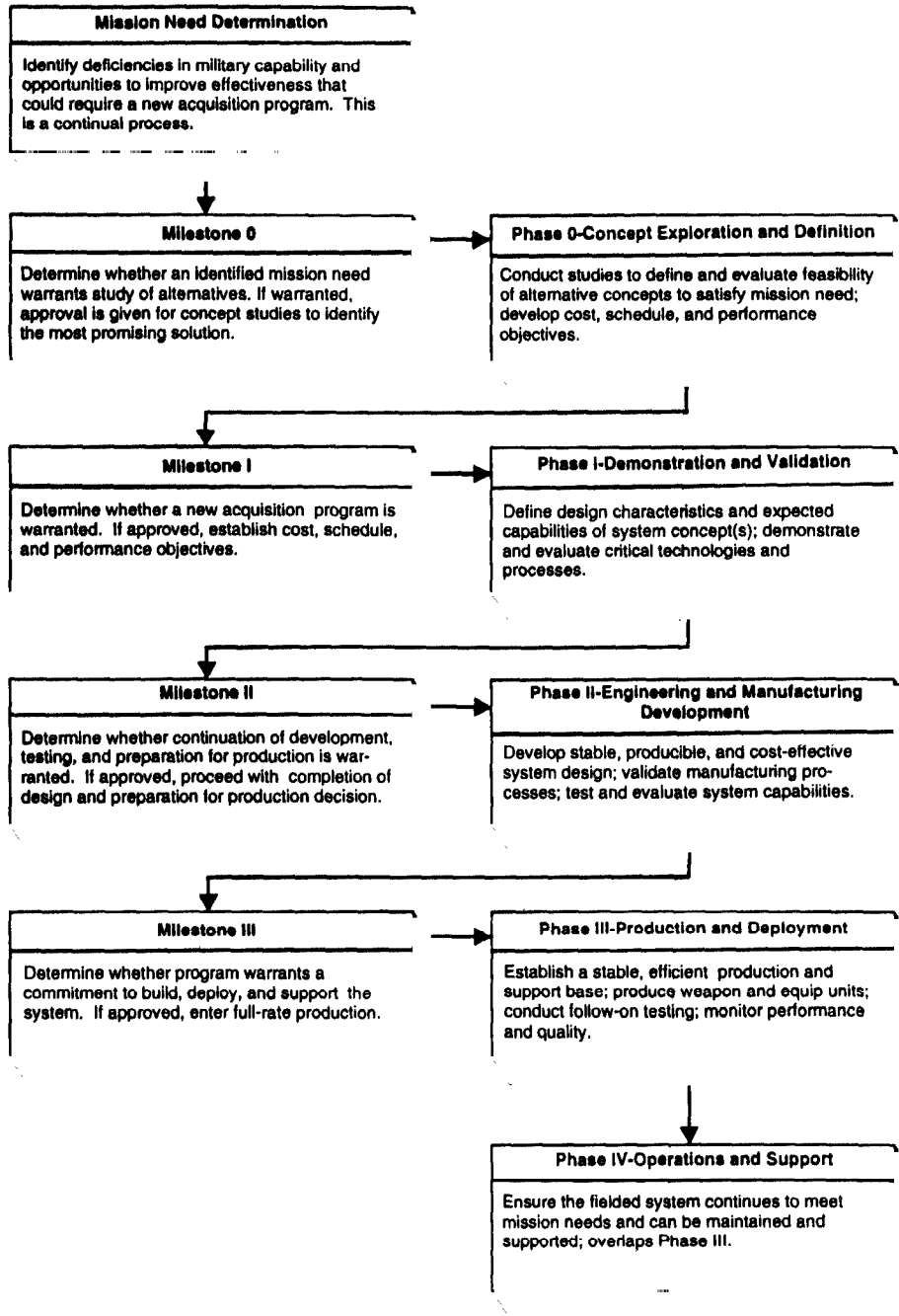

Note: A fourth milestone may be necessary to determine whether significant upgrades are needed for the weapon in production.

Since our reports of 30 years ago, our work has expanded into areas such as examining policy options for future levels of defense spending and evaluating the broad implications of decisions on the Strategic Defense Initiative, the nuclear triad, and the naval force structure. Developing more “hands-on” information on programs, we have responded to the Congress’ desire that we personally witness key tests and report our independent views directly to Committees and Members. Throughout these evaluations, we have favored solving problems and reducing risks before proceeding with programs. In addition, our work reflects our view that decisionmakers must be armed with critical and reliable information at the time decisions are made. Consequently, we attempt, as much as possible, to align our work with the key decisions to be made, particularly regarding the congressional budget and oversight cycle.

Objectives, Scope, and Methodology

Although key reform measures have led to improvements in weapon system acquisition, many problems persist. Recent changes in the geopolitical atmosphere of the world, combined with mounting U.S. budgetary concerns, provide the opportunity and the need to address persistent acquisition problems. The objective of this study is therefore not simply to catalog the findings of GAO’s previous weapons acquisition work, but rather to identify the underlying factors that we believe contribute significantly to recurring acquisition difficulties.

To accomplish this, we examined our past work, concentrating on the last 15 years of reviews of weapon systems and the acquisition process. We performed this analysis from June 1991 through September 1992. In addition to reexamining our own work, we drew upon the analyses of other organizations, including various reform initiatives, and exchanged views with numerous individuals knowledgeable in acquisition management, including several former officials from the Office of the Secretary of Defense. Using this “corporate knowledge” to extract lessons learned and to concentrate on the cultural reasons behind persistent problems has required making some judgments.

Although we did not obtain official agency comments on this report, we did discuss its contents with cognizant officials within the Office of the Secretary of Defense. These officials did not agree that acquisition problems could be ascribed to a culture. Rather, they believed that acquisition problems were more attributable to a lack of discipline and to the pressures of the Cold War. The officials noted that they have taken major steps to improve the discipline in the acquisition process and

consequently believed that our report did not accurately portray the status of weapon acquisitions today.

In general, we support the actions taken by the Office of the Secretary of Defense to improve acquisitions. As noted elsewhere in the report, we are encouraged by the willingness of the current top-level officials to forge significant change. We also believe that if these actions are sustained, they will lead to better acquisition outcomes. However, on the basis of our past and current work, we believe there is a cultural dimension of acquisition problems that helps to explain their persistence. This dimension has to do with the fact that for rational reasons the interaction of the acquisition participants engenders and perpetuates these problems. In our opinion, this aspect of the problem goes beyond discipline and beyond the control of DOD, as it involves other participants, such as the Congress. Yet we do not believe that acknowledging the cultural dimension of acquisition problems is incompatible with the actions taken by the Office of the Secretary of Defense. In fact, we believe it can complement such actions in fostering better acquisition outcomes.

In the next three chapters we discuss (1) the persistent problems faced by weapon system acquisitions, (2) the sources of problems inherent in the acquisition culture, and (3) the resistance of the culture to reform. Then, in chapter 5, we offer some suggestions on how the acquisition culture can be improved by participants, particularly within the Department of Defense and the Congress.

All photographs in this report were provided by DOD, with the exception of the photograph of the Advanced Cruise Missile, which was provided by General Dynamics.

Weapon Acquisitions Experience a Persistent Set of Problems

The weapon system problems we have reported in the past 2 years mirror those we reported in the 1970s and the 1980s. This does not imply that the history of weapon acquisitions amounts to a string of bad programs. The point is that, despite conscious attempts to improve the acquisition process, weapons still cost more, take longer to field, often encounter performance problems, and, in many instances, are difficult to produce or support. The persistence of these problems reflects the fact that the design, development, and production of major weapon systems are extremely complex technical processes that must operate within equally complex budget and political processes. If not well conceived, planned, managed, funded, and supported, problems such as cost growth, schedule delays, and performance shortfalls can easily befall a program. Even properly run programs can experience problems that arise from unknowns, such as technical obstacles and changes in the threat. In short, it takes a myriad of things to go right for a program to be successful, but only a few things to go wrong to cause major problems.

Weapon system issues have been discussed from many angles and in a variety of categories over the years. Issues such as cost growth, concurrent schedules, reliability, and affordability are often interrelated in that trying to resolve one problem can cause or exacerbate others. In this chapter, we discuss these issues within the broader context of six questions, which should be asked of weapon systems as they proceed through the acquisition cycle:

- Is the system the best solution to the mission need?
- Are the program cost and schedule estimates reasonable?
- Can the program be executed with available funds?
- Is the program's acquisition strategy reasonable?
- Has it been shown that the system is operationally effective?
- Is the system suitable for production and fielding?

Table I.1, in appendix I, identifies many of the weapon programs, by issue, on which we have reported problems over the past 15 years. It is not an all-inclusive list of program problems but is presented to illustrate how widespread the problems have been. The appendix also provides detailed examples on a number of programs.

In addressing weapons acquisition problems, we have, through the years, made many recommendations to the Congress and DOD. While these recommendations have had an impact, the persistence and pervasiveness of the problems suggest that there are underlying problems that are not

being addressed. In chapter 3 we discuss those factors we believe explain the persistence of many of the problems discussed below.

Is the System the Best Solution to the Mission Need?

DOD acquisition policies require analyses of mission needs, costs, and alternatives to ensure that cost-effective solutions are matched to valid needs before substantial resources are committed to a particular program. An important objective is to minimize overlap and duplication among weapon systems that perform the same or similar missions. This is of particular concern when more than one service participates in similar mission areas. Generally speaking, our work has concentrated more heavily on whether the military services have thoroughly and soundly analyzed solutions to a mission need than it has on whether the need is valid. We have found that, while the services conduct considerable analyses in justifying major acquisitions, these analyses can be narrowly focused, not fully considering alternative solutions, including the joint acquisition of systems with the other services.

The consideration of alternatives to the Air Force's \$3.5 billion Sensor Fuzed Weapon program is one example of the narrow focus of some of these analyses (see fig. 2.1).

Figure 2.1: Insufficient Examination of Alternatives



Multiple Launch Rocket System

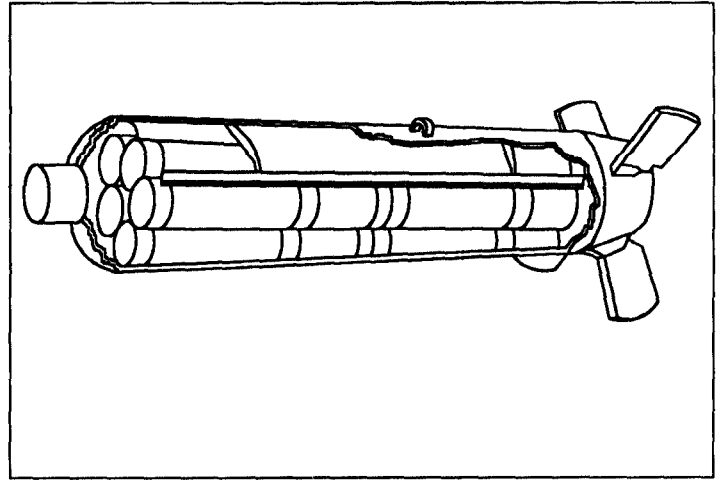

Sensor Fuzed Weapon System

Army weapon systems, such as the Multiple Launch Rocket System, were not evaluated by the Air Force as possible alternatives to developing the Sensor Fuzed Weapon System.

In an August 1991 report, we discussed the Air Force's plans to use the Sensor Fuzed Weapon primarily to interdict enemy follow-on forces before they could reinforce or replace troops at the front lines.¹ We found that the Air Force's cost and operational effectiveness analysis had not considered the full range of weapons available. Weapons such as Air Force mines and Army surface-to-surface and air-to-surface missiles and rocket systems were excluded. DOD said the Army systems had not been considered appropriate for inclusion in the analysis because each service had a valid, complementary requirement to engage enemy targets and should procure weapons to kill those targets. We believe such a policy enables the services to pursue parochial solutions regardless of what the other services are doing, unnecessarily increasing DOD's development, production, and support costs.

¹Munitions Procurement: Resolve Questions Before Proceeding With Sensor Fuzed Weapon Production (GAO/NSIAD-91-235, Aug. 16, 1991).

Similarly, in April 1992, we reported on DOD's determination of weapon system requirements for its close support mission.² Again, we found that Air Force and Army analyses of alternatives to satisfy their mission needs have been limited to specific types of weapons within their purview. The analyses gave little, if any, consideration to the contributions of other close support weapons, especially those from another service branch. This and other examples are discussed in more detail in appendix I.

Are the Program Cost and Schedule Estimates Reasonable?

Cost growth and schedule delays, two of the most prevalent acquisition problems, are also among the oldest and most visible problems associated with weapon systems. In March 1794, Congress authorized the building of six large frigates, which were to form the backbone of the Navy. The then-War Department was assigned the task of acquiring the ships. Nearly 17 months later, six keels were laid. Shortly thereafter, due to delays and cost overruns, the program was cut back to three frigates. Today, almost 200 years later, DOD is still faced with the same problems: it takes longer and costs more to develop and produce weapons than the estimates on which the programs were initially approved. These problems not only disrupt the program at hand; they cause perturbations in other programs as well. Furthermore, their occurrence suggests that previous program decisions were based on inaccurate information.

²Major Acquisitions: DOD's Process Does Not Ensure Proper Mix for Close Support Mission (GAO/NSIAD-92-180, Apr. 17, 1992).

**Chapter 2
Weapon Acquisitions Experience a
Persistent Set of Problems**

Figure 2.2: Significant Cost and Schedule Overruns

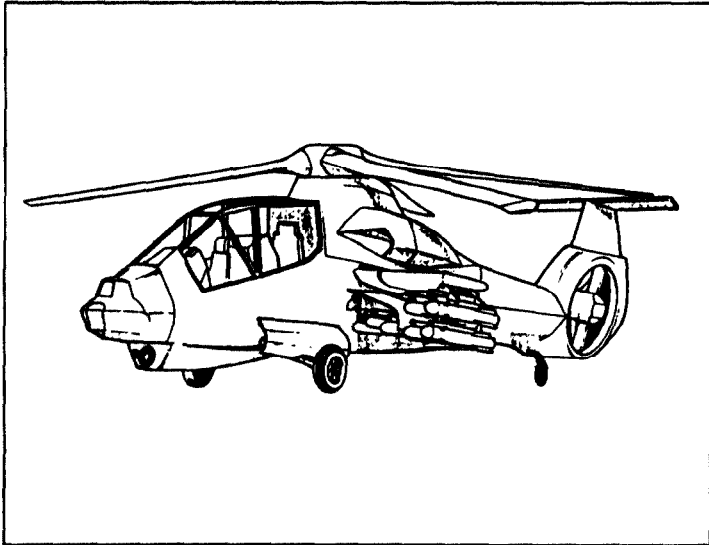

Comanche Light Helicopter

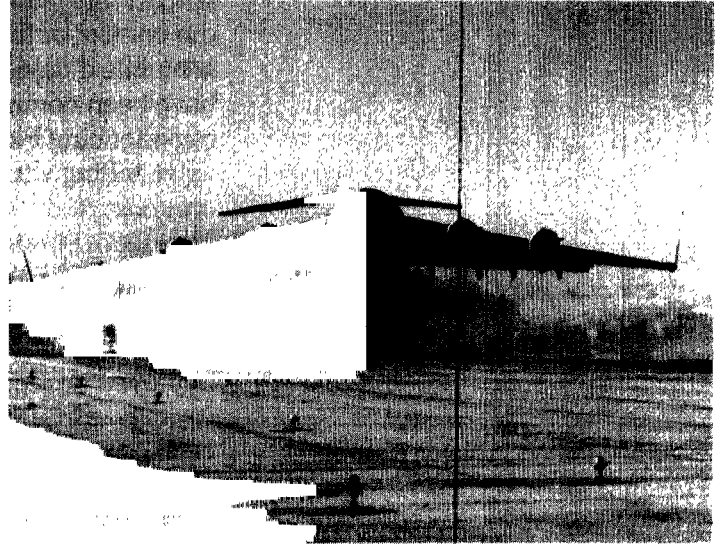

C-17 Transport

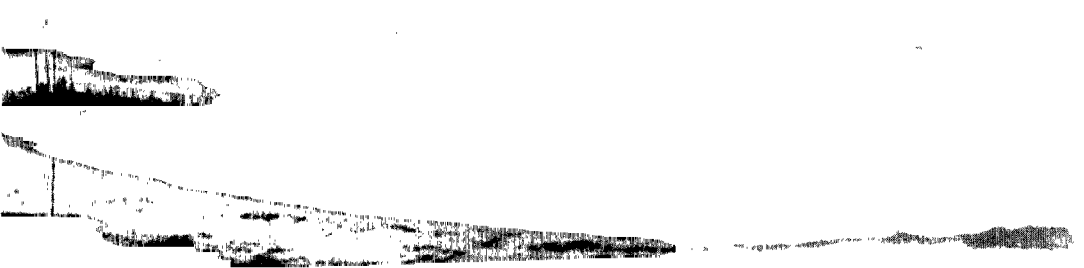

Arling Burke DDG-51 Class Destroyer

The cost and time to acquire weapons, such as these, are often significantly greater than initial estimates.

Not uncommonly, it takes 10 to 15 years to design and develop a weapon system and to produce and deploy initial operationally capable units. During this period, weapon systems, for reasons both within and outside the control of the program, tend to experience significant cost growth and schedule delays. Program cost increases on the order of 20 to 40 percent have been common on major weapon programs, with numerous programs experiencing increases much greater than that. These increases become more telling when translated into unit costs. For example, the estimated unit cost of the Comanche helicopter has more than doubled since May 1985. Similarly, schedule delays are experienced on almost every program, with the accumulation of delays on some adding up to 4 or more years. Table 2.1 summarizes the length of time between program initiation and fielding of initial units on 32 weapon systems in production and deployed on December 31, 1991.

Table 2.1: Delays in Major Weapon System Programs

Type of weapon (number of programs)	Average planned length (years)	Average actual length (years)	Average total delay (years)	Average increase (percent)
All programs (32)	8.53	10.49	1.96	22.94
Aircraft (11)	8.36	9.75	1.39	16.57
Ground vehicles (3)	6.75	8.67	1.92	28.38
Missiles (10)	8.97	11.47	2.50	27.86
Ships (3)	7.36	9.17	1.81	24.57
Other (5)	9.75	11.98	2.23	22.91

Source: GAO analysis of DOD Selected Acquisition Reports.

The extent of delays may be even greater than suggested by the table. The B-1B program, for example, reported no delays in meeting its initial fielding date of September 1986. However, the aircraft was deployed with mission-critical deficiencies in its defensive avionics system, which has never met its performance requirements. The capability of the aircraft continues, to this day, to be significantly impaired. In addition, programs suffer delays after deployment begins, when planned production rates are not achieved and production is stretched out over a greater number of years than planned.

Program cost increases and schedule delays are often the manifestation of other program problems. For example, it takes additional time and money to accommodate an expansion in program scope, to overcome technical or

production problems, and to restructure a program to absorb funding reductions. On the other hand, cost and schedule problems often result from flaws within the estimates themselves.

The desire of program sponsors to keep cost estimates as low as possible and to present attractive milestone schedules has encouraged the use of unreasonable assumptions about the pace and magnitude of the technical effort, material costs, production rates, savings from competition, and other factors. In some cases, acquisition cost estimates have been kept low by excluding relevant program costs—such as the cost of training equipment—which should be included in program cost estimates. Moreover, cost and schedule estimates are interdependent. A schedule delay, assuming program scope is not reduced, will likely drive program cost up. Similarly, a cost increase will likely protract a program schedule, unless more money becomes available.

We have reported on cost and schedule problems many times over the last 15 years (see app. I). Our September 1991 report on missile acquisition programs provides a good synopsis of these problems.³ We reviewed the 12 DOD missile systems in production that had at least 5 years of production experience. Each had encountered cost and schedule overruns, with the unit acquisition cost for 9 of the 12 having increased 20 percent or more over the planning estimates. A detailed examination of eight systems found that the unit cost and schedule planning estimates were often overly optimistic, not adequately reflecting the risks associated with the missile system's design, development, and production. Costs grew and delays occurred, reflecting the increased technological development required and the greater-than-anticipated complexity of the production processes. Key DOD program reviews, designed to help ensure that service cost and schedule estimates were not overly optimistic, did not sufficiently assess the technical assumptions behind the estimates.

Can the Program Be Executed With Available Funds?

Understated program cost estimates are a major contributor to the broader problem of affordability, which, in simple terms, can be stated as "too many weapon systems chasing too few dollars." DOD's tendency to overestimate the amount of future funding available for defense, coupled with the tendency to underestimate program costs, has resulted in more programs being started than can be executed intact (see fig. 2.3).

³Tactical Missile Acquisitions: Understated Technical Risks Leading to Cost and Schedule Overruns (GAO/NSIAD-91-280, Sept. 17, 1991).

Figure 2.3: Questionable Affordability

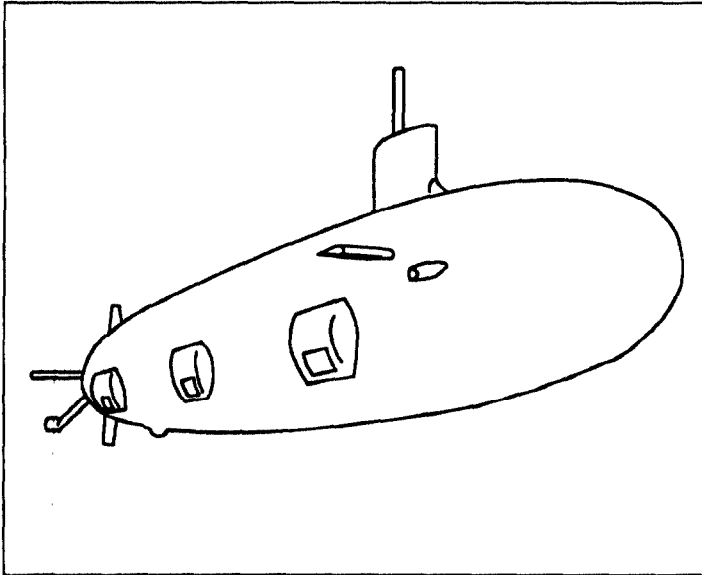

Seawolf SSN-21 Attack Submarine Program

B-2 Advanced Technology Bomber Program

Concerns regarding affordability have been raised on these and other weapon programs.

The basic framework in which DOD determines the affordability of programs is the Future Years Defense Program. It is a 6-year projection of available funds (formerly a 5-year projection) allocated to individual programs. Because all projected funds are allocated to programs, any significant increase in the demand for funds or any decrease in available funds creates a funding shortfall. Funding shortfalls, whether stemming from across-the-board cuts in defense spending, the unanticipated start of a new program, or cost growth, are eventually resolved at the individual program level. Most often, programs are stretched and reshuffled to fit within lower annual funding levels than planned—with the side effects frequently being unit cost increases, schedule delays, and program instability. Figure 2.4 illustrates the gap between actual and projected funds, as well as progress DOD has made regarding funding projections.

Figure 2.4: Closing the Gap Between DOD's Program and Budget Realities

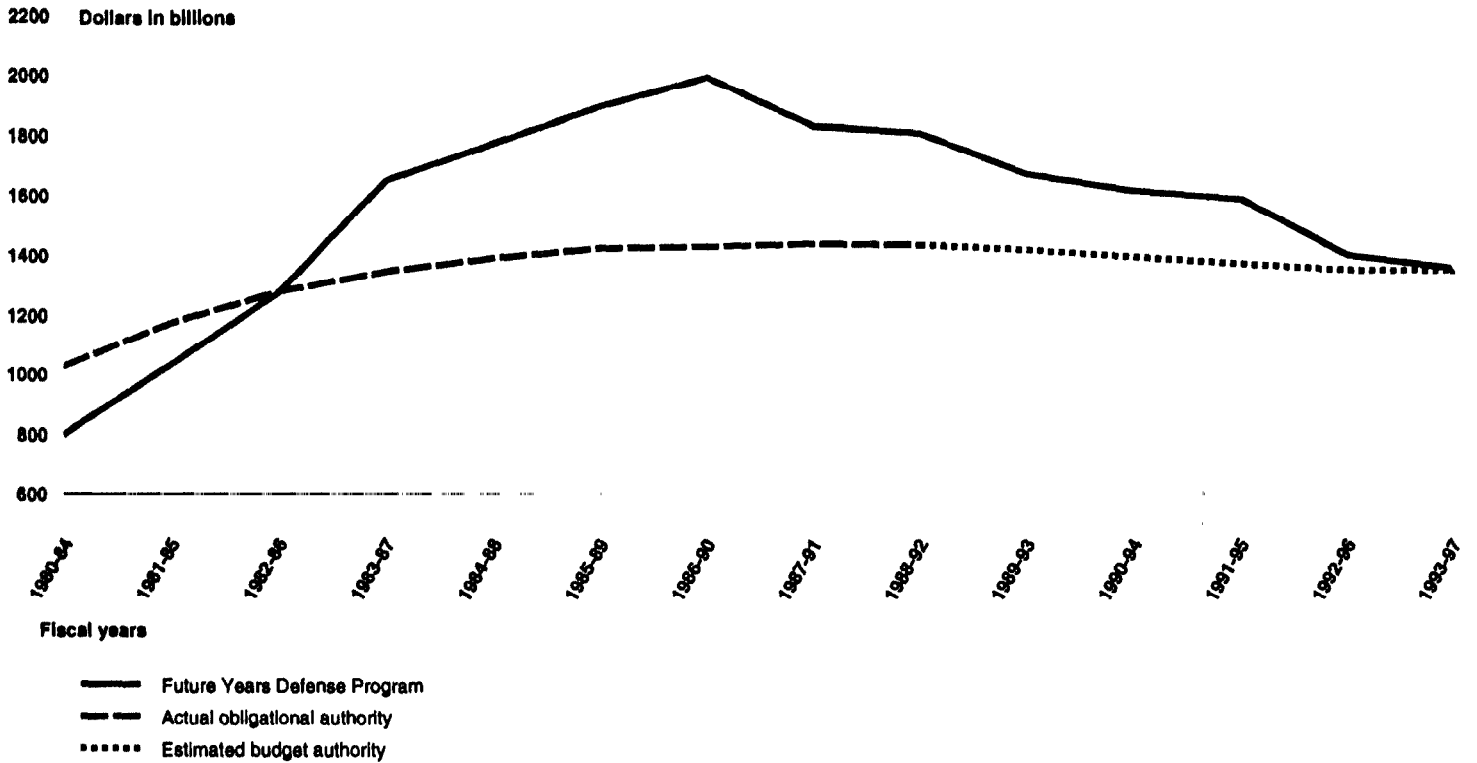

Source: GAO analysis of DOD budget data.

Evident in the figure is the large mismatch between the funding levels in DOD's program plans and those funds actually or likely to be appropriated. For example, a shortfall of almost \$553 billion existed between the 1986-90 program plan and the funds actually appropriated. Equally evident is the fact that DOD's program plans have become more reasonable. Since the 1986-90 plan, the mismatch between planned funds and likely appropriations has shrunk steadily and was nearly eliminated altogether by DOD in its latest plans.

It is clear that DOD has taken some steps to address the affordability problem—and that these steps have been accentuated by the firm full

funding policy enunciated in 1991 by top DOD acquisition officials. However, the problem is not yet resolved. The requirements and acquisition processes continue to allow programs to proceed without fully addressing affordability. Hard decisions regarding program delays or terminations are often put off to the budget preparation process, when program plans must fit within the President's budget request. Although DOD may be identifying potential offsets under the new policy, we have found that actual offsets, as in the past, are not being identified and made until later, as part of DOD's normal budget process.⁴

Further, an important factor in the affordability equation not captured in figure 2.4 is the widening effect that unplanned cost growth in weapon programs has on the funding mismatch. That is, if program costs were reasonably estimated and the pace and quantities called for in the individual program plans were not changed, the demand for funds would actually exceed the levels currently projected in DOD's program plans. Thus, cost growth will still provoke an affordability problem, even if funding projections are reasonable.

Is the Program's Acquisition Strategy Reasonable?

Two divergent criticisms are commonly levied at weapon acquisition plans or strategies. First, weapons take too long to develop and field; second, weapons begin production too quickly and are fielded with major unknowns or unresolved problems. Together, these criticisms mirror the tension among competing demands that an acquisition strategy must attempt to satisfy.

The acquisition strategy, which is a comprehensive plan of how to achieve the weapon system program's goals and objectives, is a major determinant of program outcomes. It is the service's plan for developing, fielding, and supporting a weapon, including the managerial, technical, and contractual approaches. A key element of the strategy is the program schedule, which is punctuated by major events such as testing and key decision points. The two most basic demands an acquisition strategy must meet are inherently conflicting—developing and fielding the weapon as quickly as possible to counter the threat, while minimizing technical and cost risks. A strategy optimized for accelerated fielding will likely accept higher risk primarily through concurrent development and production. Under such a strategy, major problems are more likely to be discovered in production, when it is either too late or very costly to correct them. On the other hand, a strategy

⁴Weapons Acquisition: Implementation of the 1991 DOD Full Funding Policy (GAO/NSIAD-92-238, Sept. 24, 1992).

optimized for risk aversion will result in a prolonged development schedule and increased developmental costs.

Most acquisition strategies compromise between these and other demands, such as the technical challenge being attempted and the amount of funding available. We have found that in striking these compromises, acquisition strategies embody optimistic assumptions regarding the difficulty of the technical effort; the outcome and timing of key events, such as testing; and, as discussed earlier, the cost, schedule, and affordability of the effort. The inevitable result has been acquisition strategies that are tightly strung, being both sensitive and susceptible to perturbations such as funding reductions and unanticipated technical problems. Apart from causing cost increases, such problems result in the investment of additional time and effort, the acceptance of lower performance, or the acceptance of higher risk, either in the form of increased concurrency or a reduction in the scope of the development effort.

Concurrency in the Acquisition Process

Perhaps the most troublesome characteristic of acquisition strategies in the 1970s and 1980s was the high degree of concurrency between the development and production of weapons. "Concurrency" can be broadly defined as the practice of beginning production before completing development, testing, and evaluation. Concurrency can be used to expedite the acquisition and deployment of weapon systems, and a certain amount of it can make good management sense. For example, proving out critical production technologies in development can avert major problems in production. However, the reason most commonly cited for using a concurrent acquisition strategy has been to expedite development and production so the weapon can be fielded quickly to counter the Soviet threat. Concurrency is also used to absorb delays caused by cost, funding, technical, or other problems. Such an approach increases program risk, particularly when complex or novel technologies are involved.

Figure 2.5: Excessive Concurrency in Acquisition Strategies

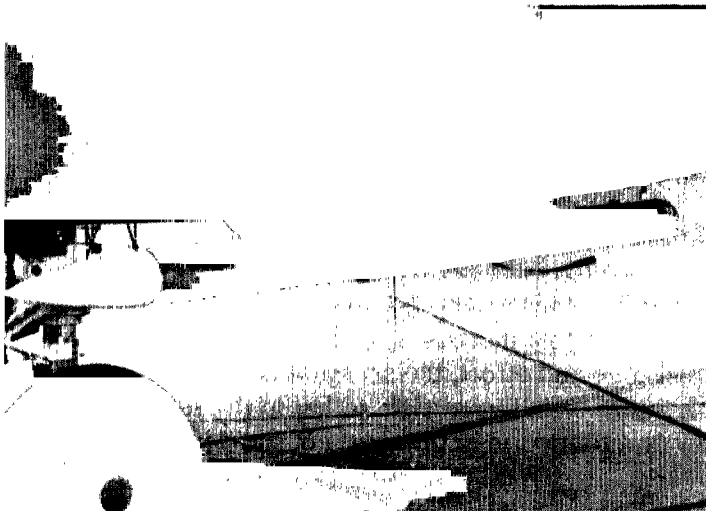

Advanced Medium Range Air-to-Air Missile

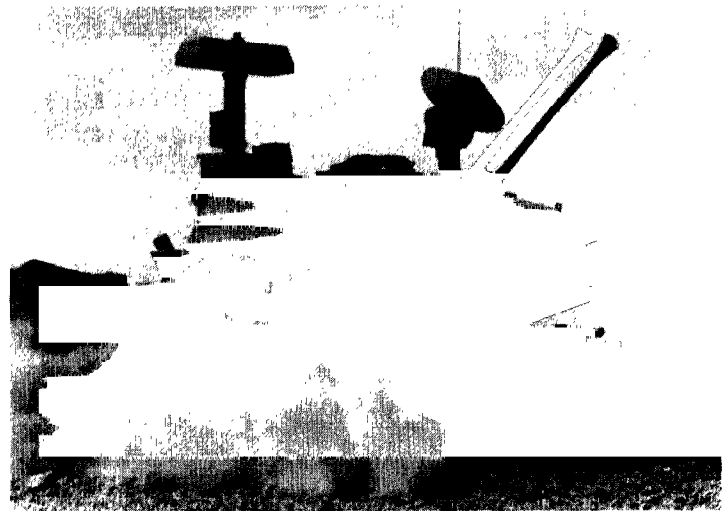

Sergeant York Air Defense Gun

Beginning production before reducing program risks has led to costly problems on these and other weapon systems.

At the very least, a highly concurrent strategy forces decisionmakers to make key decisions without adequate information about the weapon's demonstrated operational effectiveness, reliability, logistic supportability, and readiness for production. Also, rushing into production before critical tests have been successfully completed has resulted in the purchase of systems that do not perform as intended. These premature purchases have affected the operational readiness of our forces and have quite often led to expensive modifications. Among the most celebrated examples of excessive concurrency are the C-5A cargo aircraft and the B-1B bomber programs. The C-5A entered production before the aircraft was fully tested, which led to a 12-year wing modification program costing about \$1.3 billion to correct problems. On the B-1B, full-scale development and production contracts were awarded on the same day for the aircraft's defensive avionics system, which has since been plagued with problems that have seriously impaired the aircraft's capability.

When weapon system development and production schedules become more concurrent than planned, the critical function of independent operational test and evaluation often suffers.⁵ Such tests are crucial for assessing mission performance before making significant program dollar commitments. In May 1990, we reported that, based on our review of six weapon systems and other audit work, operational test and evaluation results often were not available to support decisions to start production because the military services failed to plan for such testing.⁶ In June 1985, we reported on the testing and evaluation of five weapon systems—the Air-Launched Cruise Missile, the B-1B bomber, the Sergeant York air defense gun, the F/A-18 aircraft, and the AGM-88A High Speed Anti-Radiation Missile.⁷ We disclosed that DOD had not obtained operational test results on any of the five systems before beginning production. On four of the five weapons we identified negative effects, including expensive retrofits or modifications. The Sergeant York program demonstrated the most extreme consequence. After the Army had spent \$2 billion and produced 64 of the 614 gun systems, the Secretary of Defense terminated the program because operational tests showed that the system was only a marginal improvement over the existing air defense system.

Even if the operational test and evaluation is timely, methodological shortcomings can inhibit its effectiveness. Common weaknesses in the quality of such testing that we have reported include the lack of realism, independence, and test resources in the planning, execution, and evaluation of the tests. We have also reported on long-standing problems with the completeness and accuracy of test and evaluation reports provided by the services to the Office of the Secretary of Defense and Congress.

In commenting on a draft of this report, DOD officials said they are now lessening the amount of concurrency between development and production in weapon programs. This is possible, they said, because of the end of the Cold War.

⁵Short of war, operational testing is the most realistic way of assessing weapon system performance. It puts a weapon through the rigors of combat conditions to determine its operational effectiveness and suitability.

⁶Weapons Testing: DOD Needs to Plan and Conduct More Timely Operational Tests and Evaluation (GAO/NSIAD-90-107, May 17, 1990).

⁷Production of Some Major Weapon Systems Began With Only Limited Operational Test and Evaluation Results (GAO/NSIAD-85-68, June 19, 1985).

Has It Been Shown That the System Is Operationally Effective?

Although DOD has produced many of the best and most advanced weapons in the world, these weapons often encountered significant performance problems during their acquisition (see fig. 2.6). In the extreme, some weapons—like the Aquila Remote Piloted Vehicle and the Rolling Airframe Missile—were unable to perform their missions and were either canceled or underwent costly improvements. The more common problem, however, occurs when testing or field experience shows that a weapon falls short of meeting all its performance requirements, even though it may offer better performance than its predecessor. In these instances, redesigns or upgrades are required to achieve desired performance, most often at the expense of increased program costs and of delays in the fielding of the weapon. In some instances the shortfalls are accepted.

Figure 2.6: Major Operational Effectiveness Issues

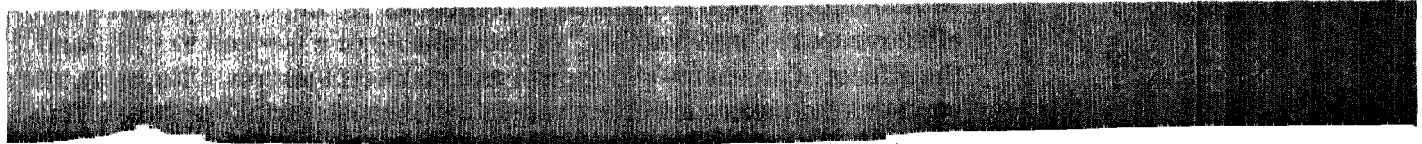

Rolling Airframe Missile

B-1B Strategic Bomber

V-22 Osprey Aircraft

The ability of these and other systems to perform effectively has been a persistent acquisition issue.

Successful performance of missions, assuming well trained operators and reliable equipment, requires a weapon system that is operationally effective. "Effectiveness" generally refers to the ability of a weapon to

successfully engage the enemy. For a majority of weapons, that means the ability to reach the target area, find targets, and destroy or disable them with munitions such as missiles or torpedoes. An important element of effectiveness is "survivability," or the capacity of a weapon to withstand the effects of an enemy's firepower and countermeasures. Ultimately, the yardstick for measuring effectiveness is the capability of the threat. Thus, even if a weapon meets its requirements, an advance in the threat could impose significant performance problems.

Given the complexities and uncertainties in weapon development and testing, the identification of performance problems is not unusual. In fact, one of the main objectives of the acquisition process is to identify and correct such problems early. Debate and controversy most often arise over the seriousness of the problem and the proper corrective action. With continual advances in the threat and design philosophies that promote the incorporation of new and emerging technologies in weapons, the challenge of overcoming problems has been continual. An area of immense technological growth has been computer software for weapon systems. For example, the Air Force's Vietnam-era F-4 fighter had practically no software; the current F-16 requires 236,000 lines of software code; and the developmental F-22 is expected to require 7 million lines of software code. The problems that accompany the development of software have led to the emergence of software as a formidable challenge in weapon system development and testing. In fact, software has been described as the "Achilles heel" of modern weapon systems because it is often a key determinant of development schedules and because the performance of key functions such as navigation, enemy detection, and fire control depends on it.

Is the System Suitable for Production and Fielding?

Although operational effectiveness problems often attract the most attention, we have found that many weapons encounter significant problems on the production line and in the field. It is not uncommon for the actual production of a weapon to require much greater effort than anticipated, with resulting cost and schedule increases. Similarly, we have frequently found that weapons break down more often and are more difficult to logistically support than planned. Apart from the cost impact, such weaknesses in the operational suitability of weapons can impair their readiness and ability to carry out missions. As with operational effectiveness, the timely identification of operational suitability problems depends on the quality of test and evaluation; the avoidance of such problems depends on a sound design process.

Production Readiness

It is DOD's policy to begin planning for production early in the acquisition process to ensure that the weapon system design not only meets performance objectives but also can be produced in an economical and timely manner. Experience, however, has shown that new weapon systems frequently encounter great difficulties as they begin production (see fig. 2.7). Problems on the production floor commonly result in high unit production costs, late deliveries, high maintenance demands, and poor field reliability. Production cost increases on the order of 50 percent are not unusual and can greatly disrupt funding plans, schedules, and program quantities.

Figure 2.7: Insufficient Attention to Producibility



Tomahawk Cruise Missile

Advanced Cruise Missile

Numerous weapons, including these missiles, have encountered production problems that increased costs and disrupted deployment.

In a May 1985 report, we analyzed the experience of six weapon systems as they made the transition from development to production.⁸ We found that, in varying degrees, production preparations, such as producibility studies and manufacturing technology projects, for four of the programs—the Copperhead projectile, Black Hawk helicopter, Tomahawk cruise missile, and High Speed Anti-Radiation Missile programs—had been sporadic and underfunded and had been largely compressed into the late stages of development and early stages of production. Program success was equated with technical performance, even at the time of production decisions. As a result, these weapons encountered significant difficulties in production that resulted in increased costs and delayed deliveries. On the other hand, production preparations for the F-16 fighter and the Air-Launched Cruise Missile had been thorough and timely because technical and production concerns had received balanced treatment. Consequently, these two weapon systems entered production without delay and major cost increases.

Despite increased recognition by DOD during the 1980s of the importance of addressing producibility in the acquisition process, we have continued to witness production problems on some of the very latest acquisitions, including the B-2 bomber, the SSN-21 attack submarine, and the Advanced Cruise Missile.

Operational Suitability

The technology that has made high-performance weapons possible has also introduced new challenges to weapon system designers to make these weapons suitable for field operations. To be operationally suitable, weapons must, among other things, be able to be effectively operated, maintained, and supported by the military forces. Our reviews have disclosed that design considerations such as reliability, maintainability, and logistics support have been compromised or otherwise not adequately considered during the acquisition process (see fig. 2.8). Performance and schedule requirements tend to take precedence over operational suitability concerns, particularly when funding shortfalls force trade-offs. The result has often been very high maintenance and support costs and lower-than-expected availability for operations.

⁸Why Some Weapon Systems Encounter Production Problems While Others Do Not: Six Case Studies (GAO/NSIAD-85-34, May 24, 1985).

Figure 2.8: Operational Support Problems

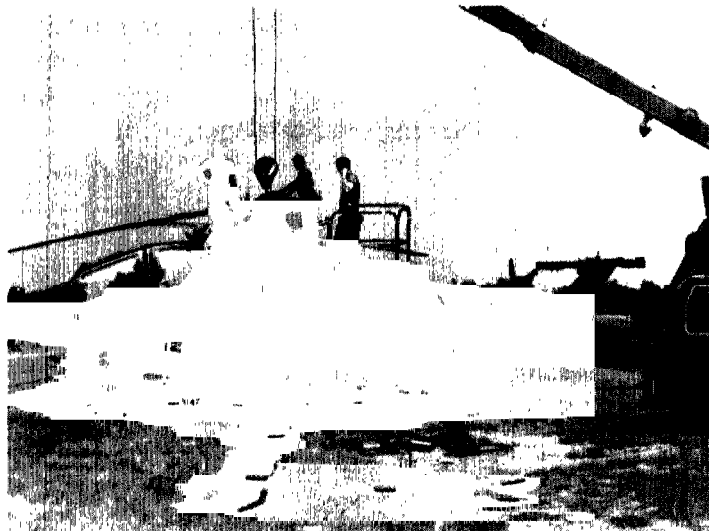

Apache Helicopter

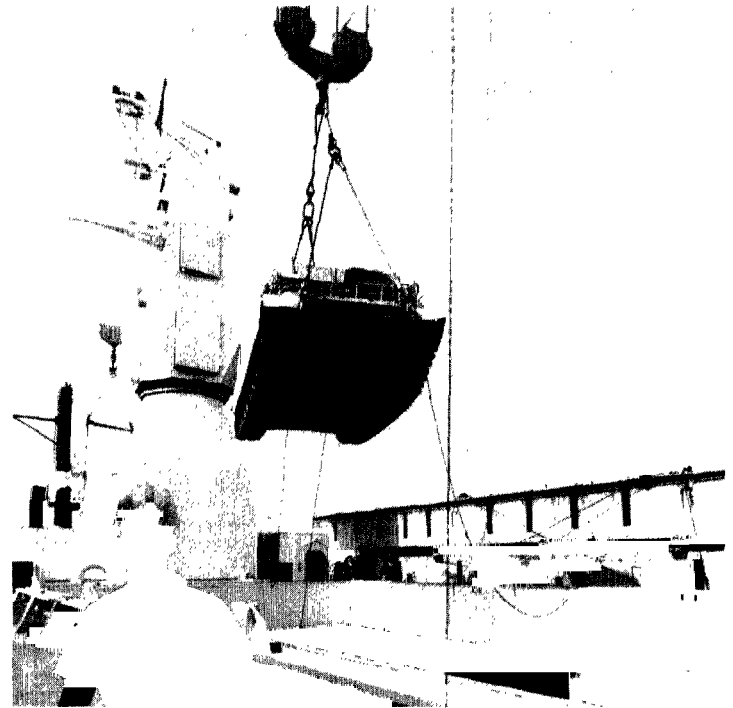

M-1 Main Battle Tank

The maintenance and support required of many high performance weapon systems, such as these two Army systems, are often very costly and can affect the system's operational availability.

Limitations in the quality of test and evaluation—such as the immaturity of prototypes and optimistic interpretation of reliability data—can obscure or delay recognition of operational suitability problems. For example, in reviewing the Army's evaluation of operational tests completed in 1990 on its Air Defense Antitank System, we found that the Army had excluded the test data from missile firings in calculating the system's operational availability.⁹ These firings were critical because they marked the only time during testing that the entire system was in operation. In addition, although the system requirements stipulated that all unscheduled maintenance time be included in test calculations, we identified at least 145 hours of such maintenance that had not been included. The effect of these exclusions was to overstate the system's demonstrated operational availability.

⁹Army Acquisition: Air Defense Antitank System Did Not Meet Operational Test Objectives (GAO/NSIAD-91-51, Dec. 10, 1990).

Although DOD took steps during the 1980s to place increased emphasis on operational suitability considerations during the acquisition process, we continue to witness weapon systems being deployed without reliable support and test equipment or with design problems that require retrofits and modifications to make them suitable for field use. Examples include the Apache helicopter, the Advanced Medium Range Air-to-Air missile, and various electronic warfare systems, including their test equipment.

Persistent Problems May Be the Consequences of the Acquisition Culture

While occurrences such as performance shortfalls, schedule delays, and cost increases are recognized as persistent problems in weapon acquisitions, we believe that they should also be viewed as the logical consequences of the acquisition culture. This culture can be defined as the collective behavior of the various participants in the acquisition process—principally DOD and the Congress—and the forces that motivate their behavior. In fact, the process may be more realistically portrayed as the interaction of its participants than as the methodological procedure depicted on paper. This culture has evolved as the acquisition process has become a vehicle for meeting the diverse needs of its participants through the steady initiation and sustainment of programs.

While individual participants see their needs as rational and aligned with the national interest, collectively, these needs create incentives for pushing programs and encouraging undue optimism, parochialism, and other compromises of good judgment. Under these circumstances, persistent performance problems, cost growth, schedule slippage, and difficulties with production and field support cannot all be attributed to errors, lack of expertise, or unforeseeable events. Rather, a level of these problems is embedded as the undesirable, but apparently acceptable, consequence of the process. These problems persist not because they are overlooked or under-regulated, but because they enable more programs to survive and thus more needs to be met. The problems are not the fault of program managers or any single participant; they are the collective responsibility of all participants.

The Acquisition Process Responds to the Needs of Its Participants

Within the framework of national security, the acquisition process generally, and weapon programs specifically, must make winners of the key participants. On this score, the acquisition process does quite well. As a weapon makes the difficult journey from concept to the field, it is debated, stretched, threatened, accelerated, delayed, and redefined to conform to the needs of the participants. Even critics and independent agencies benefit in that weapon systems provide a forum for debate that helps reinforce their roles. Over time, the nearly unassailable urgency of the threat and the ability of weapon programs to help participants achieve goals have institutionalized a culture that prefers continuing a program to terminating it and hinders making difficult trade-offs to alleviate cost, affordability, duplication, risk, and logistic supportability concerns. Collectively, these needs shape the cultural problem, for they cannot be easily met without an ample supply of programs.

**Weapon Programs
Represent a Common
Solution to Diverse Needs**

Weapon systems are one of the few common vehicles for meeting a wide variety of defense needs. Within the acquisition process itself, the survival and replenishment of weapon programs have become intertwined with the basic needs of the participants. The most pervasive need over the last 40 years has been to counter the threat posed by the Soviet Union and the Warsaw Pact. Until recent years, this threat was seen as an ever advancing and numerically superior force that necessitated urgent and continuous U.S. efforts to field technologically superior weapons. In the 1970s and 1980s, a general consensus developed between the different administrations and the Congress on the need to modernize U.S. armed forces through new weaponry. This consensus was manifested by the broad range of programs started during that time.

However, the process of acquiring new weapons—as defined by the process's many participants—is far more complex than the seemingly straightforward purchase of equipment to defeat an enemy threat. Acquisition process participants include the military services and the individual warfare communities within each service; the offices of the President, the Secretary of Defense, and the Joint Chiefs of Staff; independent oversight organizations; contractors; political action committees; professional associations; and the Congress. Their interaction often reflects a conflict between the optimism that accompanies program sponsorship and the skepticism that accompanies oversight of the process. Ironically, the presence of one fuels the other. While program sponsors are often considered synonymous with program managers, sponsors include all participants who support a program on its own merits or because they stand to benefit from such support. On the other hand, participants who challenge or oppose individual programs are considered program skeptics; these can include independent evaluators, allocators of resources, and supporters of competing programs.

Individual needs that the acquisition process attempts to satisfy are depicted in figure 3.1.

Figure 3.1: Weapon Acquisition Programs Meet Many Diverse Needs

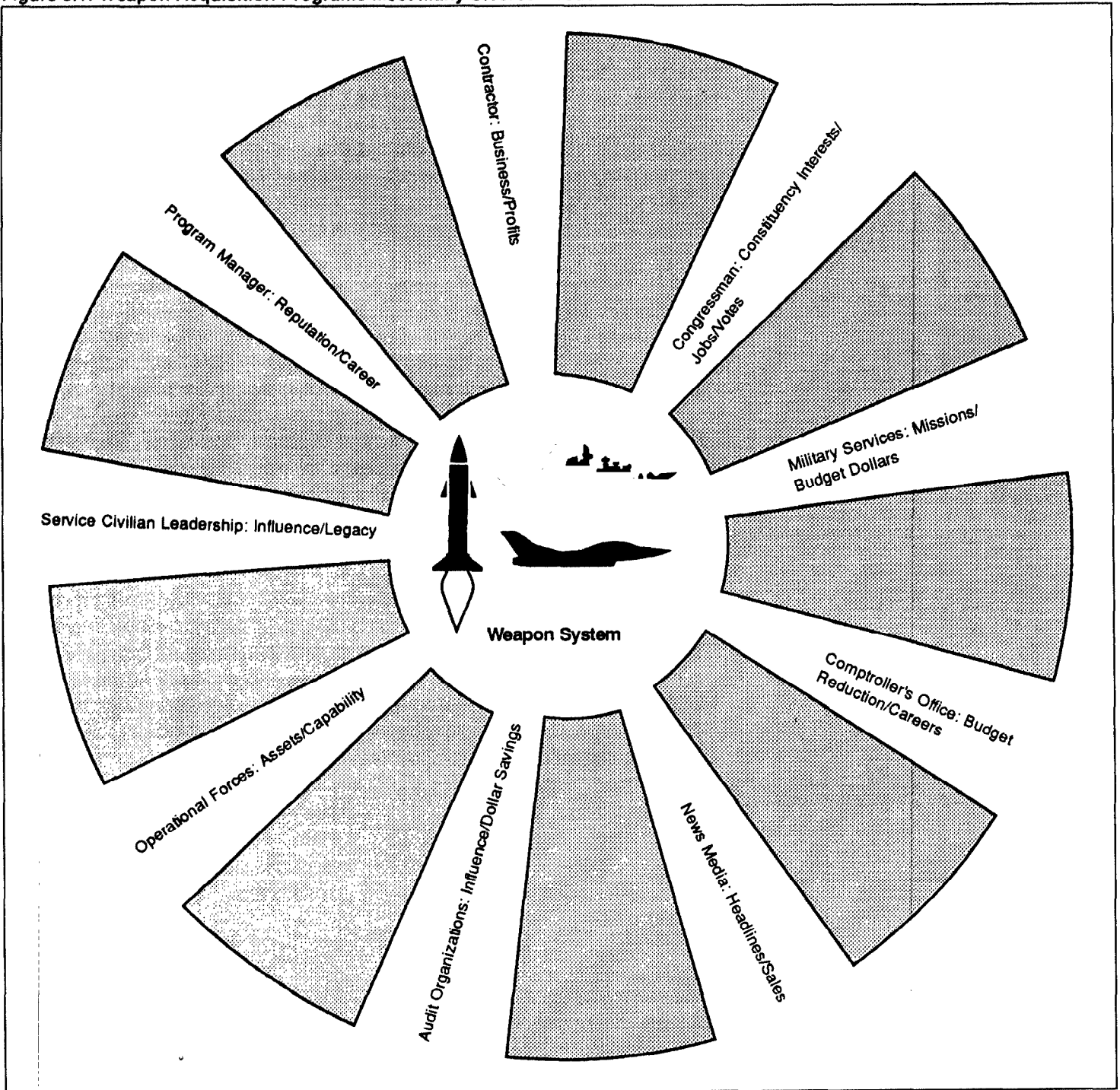

Although individual participants may act rationally based on their views of national security interests, their actions are governed by their backgrounds, the biases of their institutions, and their perceptions of rewards and punishments. Furthermore, the short tenures of many acquisition participants encourage them to take actions that have near-term payoffs. More near-term rewards can be found in starting and supporting programs than in making difficult decisions in the present to solve longer term problems. Participants are also influenced by how they anticipate others may act; for example, a service's candor about test results is affected by how these results could be used by program critics.

Collectively, as participants' needs are translated into actions on weapon programs, the purpose of such programs transcends efficiently filling voids in military capability. Thus, weapons have become integral to policy decisions, definitions of roles and functions, justifications of budget levels and shares, service reputations, influence of oversight organizations, distribution of funds to localities, and the industrial base. Programs are also important to individual careers. For example, a program manager's success depends on getting results, and in acquisitions, results mean getting the program through the next major milestone and into the field. Thus, a program manager's strongest motivation is to keep the program moving and to protect it from interruption.

Strong incentives for supporting programs permeate other levels of the acquisition process as well. To a contractor, the basic incentive may be winning business. To a service branch, it may be perpetuating a mission. To a service, it may be securing its reputation and its share of the budget. To a Member of Congress, it may be responding to constituency interests. To service executives, whose tenures are often relatively short, weapon systems can be an effective way to leave a legacy. Under this set of incentives, programs—like the B-1—that are eventually fielded despite performance, cost, and other significant problems are often considered more successful than programs—like the Sergeant York—that are canceled because serious flaws were discovered before fielding. When in conflict with responsible management, “successful” outcomes may carry more rewards.

Difficult Choices Carry Few Rewards

While decisions to create and sustain acquisition programs are encouraged by strong incentives, decisions that restrict or control programs operate under weak incentives. Unfortunately, these are often the kinds of decisions necessary to solve problems and to improve acquisition

management. For example, because funding acquisitions is a “zero sum” exercise—that is, the decisions made must fall within a given level of spending—actions such as improving the realism of a program’s cost estimate or reducing its concurrency will either jeopardize the program at hand or take resources from other programs. Such decisions face strong disincentives because they conflict with the other, more powerful, needs served by the programs.

The traditional difficulty acquisition process participants have had in dealing squarely with affordability limitations is a case in point. In a collective process that favors compromise, decision-makers have preferred to find ways to afford, rather than decide whether to afford, individual programs. The result has been to sustain more programs at lower funding levels rather than to fully fund fewer programs. Under the prevailing culture, program sponsors are motivated to make optimistic cost assumptions and to reduce quantities or program scope or to prolong the schedule to make a program affordable and thereby avoid cancellation. Although these actions do not solve the long-term affordability problem, they lessen the need for decision-makers to make difficult choices among programs. Ultimately, program survival has proven a more powerful incentive than program affordability.

Even when DOD makes the difficult choice of canceling a program, the Congress, in some instances, continues to support it. Such was the case during the 1992 budget process, when DOD decided to discontinue the M-1 tank modernization, V-22 Osprey aircraft, and SSN-21 Seawolf submarine programs. Each of these programs continued to receive support by key congressional committees, and DOD eventually withdrew its opposition. In other instances, new weapon systems end up complementing, rather than replacing, existing weapons that have strong constituencies. For example, production of the B-1A strategic bomber was terminated in 1977 with the advent of the cruise missile. Although the cruise missile began fielding in 1981, the bomber program was resurrected and fielded in the form of the B-1B.

Thus, although the acquisition process has long been criticized for the instability it imparts to individual programs, the process may in fact have achieved stability at a more basic level. Perhaps reflecting the incentives for preserving programs, the number of programs has remained relatively stable compared with the growth and decline in funding levels over the last 16 years, as shown in figure 3.2.

Figure 3.2: Weapon System Funding Levels and Line Items Over Time

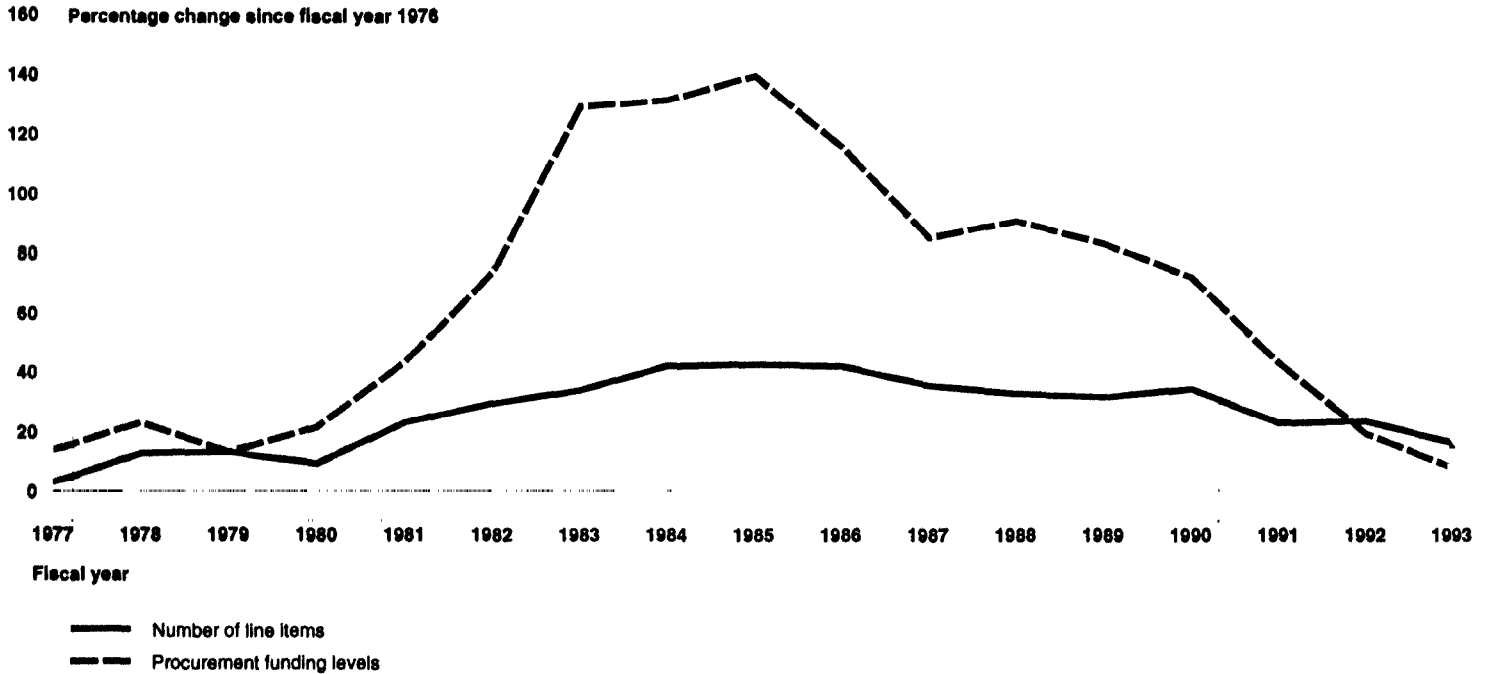

Notes: Funding levels are standardized as constant fiscal year 1992 dollars. Data for fiscal years 1992 and 1993 are estimates.

Source: GAO analysis of DOD budget data.

This relative steadiness in program volume suggests a broader view of program instability that recognizes the incentives of the acquisition culture. It is true that programs are routinely disrupted as a result of DOD and congressional actions, prompting the charge of “micromanagement.” On the other hand, this same propensity for disruption—versus cancellation—has enabled more programs to survive and has accommodated the problems that tend to be inherent in programs. In this sense, individual programs are not the innocent victims of an unstable acquisition process; their “instability” may well have been the price paid for survival.

Problems Embedded at the Outset of Programs

Weapon system problems can often be traced to the very beginning of the acquisition process. In addressing mission needs, service organizations propose programs that perpetuate their existence and oversell the programs to ensure their survival. Predictably, programs begin as parochial solutions embodying highly optimistic estimates. In this sense, program justifications may be more heavily influenced by the participants' needs than by objective decision-making. That is not to say that the process is irrational or arbitrary. To the contrary, the general threat may be legitimate, and individual program analyses may be objective. However, these factors do not necessarily dominate decision-making because they can be tailored by other participants in the process. More importantly, if the proposing organizations were to act more objectively, they could doom their own programs and jeopardize their own existence.

The decisions made in justifying a program are crucial because they largely determine the eventual performance, schedule, and cost of the weapon system. An approved requirement embodies how a weapon is to perform its mission and often the specific technical characteristics it is to possess, thereby setting the tone for the remainder of the acquisition. A requirement, for example, for a manned strategic bomber with stealth features dictates the cost and duration of development and production.

Programs Begin as Parochial Solutions

The parochialism endemic to the services' structures for developing weapon system requirements tends to narrow consideration of alternatives and to favor the promotion of particular weapons. The convergence of parochial preferences and of the demand for high performance in justifying weapons creates incentives for developing requirements that embody a preferred solution against which alternatives can hardly compete. The result is not necessarily that the best solution to a valid need is selected but that the preferred solution is successfully justified.

The organizations responsible for developing requirements for new weapons generally represent individual branches within the services that analyze their own mission area deficiencies and recommend solutions from within their particular branches. In addition, defense contractors routinely market ideas for new weapons to the cognizant service branches. Consequently, when an organization such as the Army Aviation Center identifies deficiencies based on its analysis of the threat, it proposes solutions in terms of Army helicopters. Similarly, the responsible Air Force command identifies deficiencies and recommends solutions in terms of fixed-wing aircraft. This organizational alignment largely explains

why in 1971, we reported that the Air Force had not included Army attack helicopters as candidates for the close air support mission (the A-10 was eventually selected)¹ and why, in the 1980s, the Army did not consider Air Force fighters as alternatives to developing the Comanche light helicopter.

These service organizations, over time, have institutionalized an advocacy for the weapons under their purview and helped perpetuate the funneling of successor weapons into the acquisition process. Under this system for developing requirements, programs are justified on the basis of their unique characteristics under the protection of closely guarded missions, making it difficult to broadly assess which alternative best serves the general defense. Such narrow reviews of missions and requirements, together with each service's unwillingness to compromise on design or performance goals for weapon systems, contribute to the services' large investment in service-unique weapons that perform similar missions. Fighter/attack-type aircraft, summarized in figure 3.3, are illustrative: the Navy's F-14 and the Air Force's F-15 are both air superiority fighters; the Navy's F/A-18 and the Air Force's F-16 are both multi-role fighters; and the Army's attack helicopters, the Air Force's A-10, and the Marine Corps' AV-8Bs and Cobra helicopters all provide close air support for ground forces. For most of these aircraft, there is also a program either to modernize the aircraft or to develop a replacement.

¹Acquisition of Major Weapon Systems (B-163058, Mar. 18, 1971).

Figure 3.3: U.S. Active, National Guard, and Reserve Attack and Fighter Air Forces

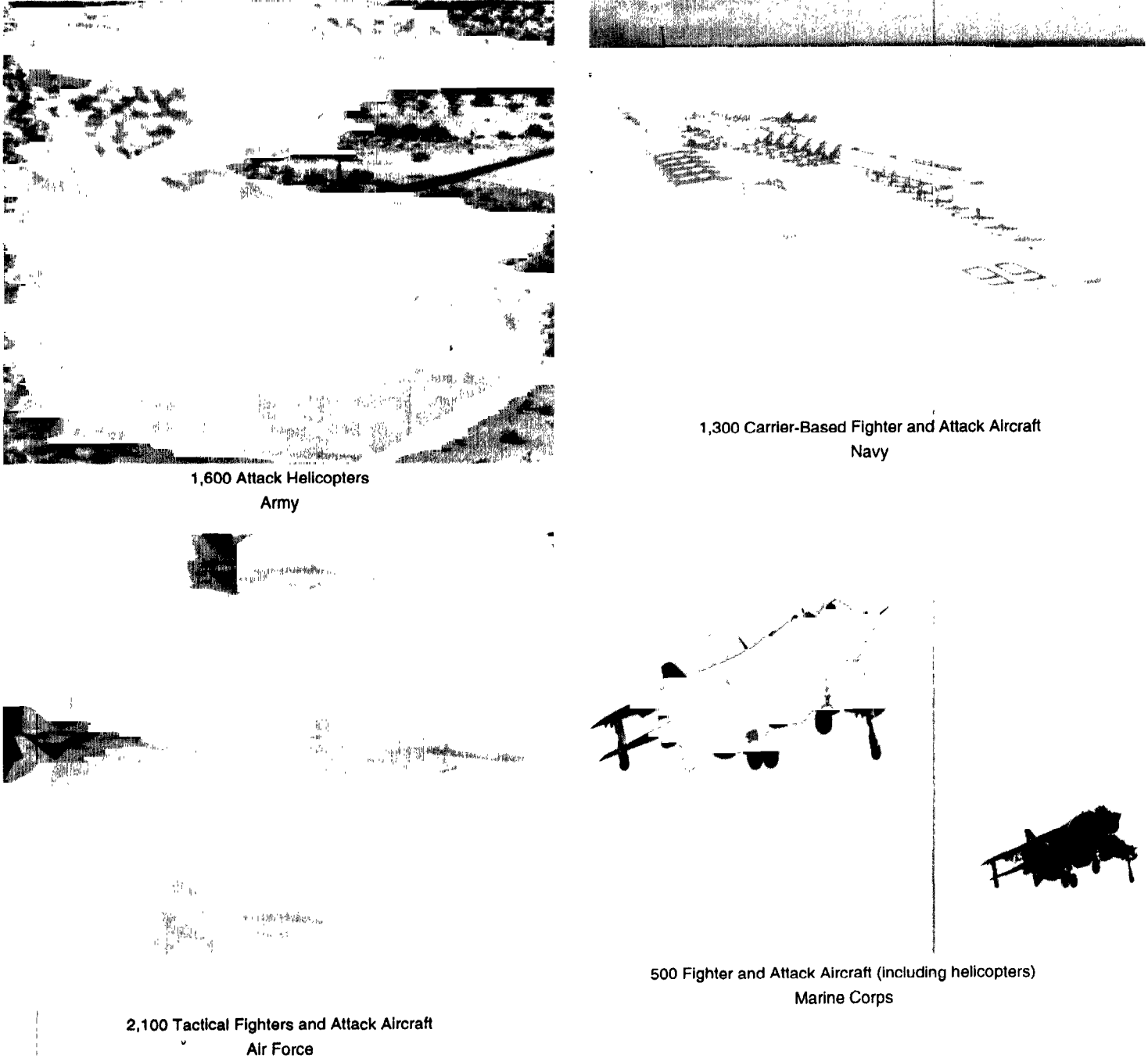

Unique service requirements have led to the acquisition of numerous types of aircraft with similar missions. (Figures are approximate.)

The Army attempted to reduce the parochial influence of its individual requirements centers by having an integrating arms center conduct combined mission area analyses. However, in a 1986 review, we found that reviewers at the new center had the same parochial point of view as the requirements developers in the individual centers.² The Acting Secretary of the Navy, responding, in part, to the problem of parochialism, announced a reorganization of the Navy's headquarters staff in July 1992. The primary objective of the reorganization was to better integrate the Navy's three warfare communities—surface, air, and submarine—to end intraservice rivalries and to pursue integrated solutions to operational needs.

Programs Must Be
Oversold to Survive

Most programs are initiated as solutions to perceived deficiencies in the ability to carry out missions against a projected threat force. These solutions generally translate into time-critical needs for substantial improvements in technical performance. Given the tendency to overstate the capability of future threats, program sponsors are encouraged to write demanding performance requirements that further distinguish their weapon as the preferred solution. These demands lead to "goldplating," whereby design features are added, even though their cost far exceeds their real value. A complementary weakness in drawing up requirements is that the authors are not necessarily experts in technology. Consequently, they may lack the expertise to trade off the increased cost and technical risk associated with increased performance requirements, making it easier to overstate needs. While it may be easy to criticize the authors of such requirements, it must be kept in mind that this approach works: it is a successful, if not essential, way to win program support from higher level participants. By their actions, the higher level participants, including the Congress, reinforce the formulation of demanding performance and schedule requirements.

To win support, programs not only have to offer high performance and ambitious schedules, but they must also be affordable and cost-effective. These additional demands can promote undue performance, schedule, and cost optimism. For example, DOD regulations require that analyses assessing the cost and operational effectiveness of various alternatives (including the incumbent weapon) for meeting a mission need be prepared and considered at major program milestone reviews. Given that the new system is already favored by the service organization responsible for the requirements, the cost-effectiveness analysis can further encourage the

²Weapon Systems: Observations on Army's Efforts to Improve Its Requirements Process (GAO/NSIAD-87-21, Oct. 29, 1986).

use of optimistic assumptions of performance and cost. Contractors contribute to the optimism by bidding low in their desire to participate in the program and by proposing designs that promise exceptional or unique performance capabilities.

In our experience, cost-effectiveness analyses rarely show an alternative system to be the preferred solution. Even when an alternative system offers a potentially more cost-effective solution, program sponsors are not likely to be dissuaded from their preferred choice. For example, in our recent review of the Milstar communications satellite program, we found that a 1991 DOD study had identified an alternative for satisfying satellite communication requirements that had a life-cycle cost estimate that was several billion dollars less than that of the recently restructured Milstar. In response to our report, DOD said that it preferred the restructured Milstar, citing larger cost uncertainties and higher development risks with the alternative, even though its own 1991 study had concluded that the risks were the same.³

Under the prevailing culture, attributes such as high reliability, ease of maintenance, and practicality are desirable features but are generally not enough to justify a program. The Army's Comanche helicopter program is a case in point. This program was initiated in the early 1980s by senior Army management as a family of lightweight, multipurpose helicopters whose justification centered on practicality rather than the threat. The program was expected to inexpensively replace a fleet of Vietnam-era helicopters with new helicopters that would be up to 50 percent cheaper to operate and support. Within these economical confines, the new helicopters were to offer as good a technical performance as was possible. Subsequent to this genesis, however, specific requirements were developed through the process described above, and the program emerged as it is today—a threat-based program to yield the next-generation, high-performance helicopter at a cost significantly higher than that of the Apache, the Army's most advanced and costly helicopter.

Incentives for Continuing Programs Grow More Powerful Over Time

As a program proceeds through development, the disposition for sponsors to present program information optimistically and to protect the program against disruption intensifies. This behavior is necessary to overcome the numerous challenges a program faces as it commands increasing funds and faces potential criticism. At the same time, program support grows

³Military Satellite Communications: Milstar Program Issues and Cost-Saving Opportunities (GAO/NSIAD-92-121, June 26, 1992).

because more acquisition participants have become active sponsors and because the time and money invested have built a compelling argument for continuing the program. Together, these factors complement the initial efforts to push the program and begin to pull it through the acquisition process. They enable the program to develop “a life of its own” and to become its own objective. Thus, even when the very underpinnings of a program are badly shaken, very strong arguments are made by participants at all levels to continue the program as planned. This is particularly true for programs that have entered the engineering and manufacturing development phase (formerly full-scale development), by which time it is generally conceded that the programs are committed to production. Ironically, if a weapon has serious problems, these problems are most likely to surface during this phase—when the program has become virtually unstoppable.

The basic motives of program sponsors are further galvanized by the adversarial nature of repetitive budget and program reviews. Collectively, multiple reviews have been a major source of instability. A program's budget request must survive the approval of the service, the Office of the Secretary of Defense, the Office of the President, and at least four Committees of the Congress. Each review represents a threat to the program in the form of potential budget cuts and program redirections. Because budget requests actually function as vehicles for programs to obtain needed income, the review process makes the palatability of program information more important than its objectivity. Thus, budget reviews can encourage further optimism, especially during the more costly program phases.

Major programs must also survive Defense Acquisition Board or service-level reviews before they can proceed to the next acquisition phase. These reviews can be direct challenges to the program's existence and can demand proof or assurances that the program (1) will meet its performance, schedule, and cost objectives; (2) is still a cost-effective solution to a valid need; and (3) is still affordable. At program reviews, information outside the program manager's control—such as independent test evaluations and cost estimates—can challenge the validity of the information presented by the program manager. Even if a program survives a major review intact and is approved for the next acquisition phase, the decision must then be ratified by the Congress in terms of funding and program approvals.

When faced with challenges, sponsors must staunchly defend their program to protect it and ensure its continuance. This discourages the promulgation of realistic information that discloses problems because any sign of weakness could cause the Office of the Secretary of Defense, the Congress, or even the service to take funds from the program. Similarly, critical information developed by oversight organizations, such as our office, the Cost Analysis Improvement Group, the Director for Defense Operational Test and Evaluation, the Inspector General, or by the press, will likely be downplayed and rebutted by the sponsors. Again, the sponsors' reactions are rational, because they realize that bad news can tip the scales of power against the program, leading to funding cuts and possible program termination. The critics' tendency to seize upon negative information whenever it becomes available is equally rational, as their opportunities to influence a program can be few.

As a program survives the challenges of reviews at the service, Secretary of Defense, and congressional levels, many of these participants become program sponsors. For example, if a service acquisition executive chairs a major review that eventually approves a program, that executive will likely sponsor and defend the program to the Secretary of Defense and Congress. At the congressional level, the voter constituency that would benefit from the income local contractors would receive through the program imparts a real pressure on Members to support the program. Consequently, sponsors can broaden the support for a program by maximizing the number of states represented in the contractor base. A dangerous situation from an overview standpoint occurs when the principal decisionmakers become program supporters before they conduct their formal reviews. Given the enormous advantage this situation gives to the program, a key objective of program sponsors is to win over the higher levels of participants before these higher levels formally review the program. Consequently, creating this situation is a key goal of lobby efforts.

The Navy's Airborne Self-Protection Jammer program exemplifies how a weapon acquisition can gather momentum as it proceeds through the process and how it can become difficult to stop even when serious deficiencies are known (see fig. 3.4).

Figure 3.4: Airborne Self-Protection Jammer

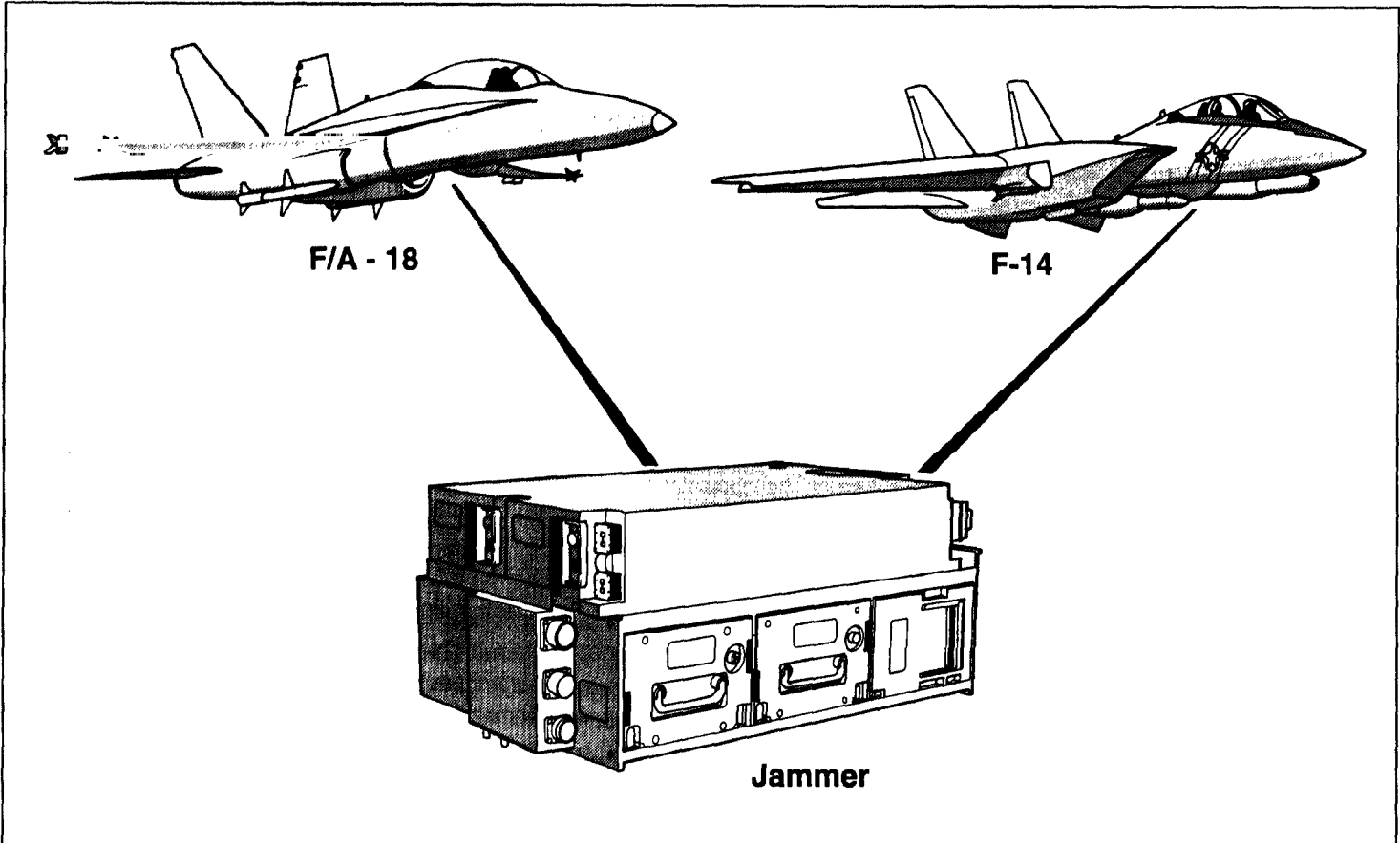

The testing criterion for this system was adjusted, enabling continued production despite known deficiencies.

In 1989, DOD approved initial production of the Airborne Self-Protection Jammer, which is designed to provide protection for F-14 and F-18 aircraft, despite its marginal performance during operational testing. DOD cited the urgent need and the absence of alternatives as the reasons for approval. In 1990, the DOD Inspector General proposed, and we recommended, that deliveries from the first lot be stretched out to allow for complete operational testing without a break in production. DOD did not agree to take this action. DOD did, however, establish reliability and performance criteria that had to be achieved before the second production lot would be approved. When tests began to show that system failures attributable to software errors would cause the jammer to fall well short of the reliability criterion, the Navy redefined the criterion to exclude such failures. The jammer met the reduced criterion. The Defense Acquisition Board,

cognizant that software failures had been excluded, nevertheless approved the second lot following a June 1991 program review. The Board's chairman, the Under Secretary of Defense for Acquisition, cited the need to avoid a production break as a rationale for the approval. In December 1992, after the jammer failed independent operational testing, the program was terminated. At that time, 136 of the approximately 600 planned units were under contract.

Cultural Differences in Successful Programs

Programs that are successful in terms of meeting performance expectations while remaining relatively free of cost and schedule problems have operated within a different set of incentives than most other programs. Over the years, we have reviewed several programs that are considered successful, including the Fleet Ballistic Missile, F-16 fighter, and Multiple Launch Rocket System programs. Because these programs were set up either as special projects or to achieve less risky performance goals, they were spared the oversell and consequent performance bias that characterize most programs. These programs also enjoyed the continued funding support of DOD and the Congress. Consequently, they were less influenced by the pressures that stem from the fear of technical failure and the constant need to market the program to secure funds. Rather, these programs proceeded as executable programs that did not have to rely on optimism and protectionism to survive.

Successful programs have tended to pursue reasonable performance objectives and avoid the cascading effects of design instability and the equation of program success with technical success. Freed from normal acquisition pressures, these programs were better able to trade off performance requirements with other needs such as cost and producibility; they have existed in an environment where realism is encouraged. For example, while the Fleet Ballistic Missile program was set up in the 1950s as a concentrated effort to achieve technical breakthroughs to field an urgently needed weapon, in the following 35 years it has fielded new weapons through evolutionary technical advances. Similarly, the F-16 was conceived as a low-cost alternative to the F-15 and did not have as demanding performance requirements to meet. Consequently, its design was optimized for light weight and low cost and relied on design features and components that posed lower performance and production risks. Furthermore, its design was proven out in a competitive fly-off, and changes were minimized by the multinational consortium that was to produce it.

An unsettling footnote to successful acquisition programs is the fact that, in general, they benefit from a set of circumstances not routinely available to most programs. Unlike the Fleet Ballistic Missile program, most programs cannot be set up as special projects that operate within a unique set of rules. Nor have most programs enjoyed the flexible performance requirements instrumental to the F-16's success. Even the relative success of the Air-Launched Cruise Missile program can be largely attributed to its top priority and the ample funding that enabled full competition throughout pilot production as well as the dual-sourcing of major components. The challenge in extracting lessons learned from these successful programs is in determining whether such lessons can be used to change the culture in which most programs must operate.

The Confrontation Between the Acquisition Culture and Reform

The acquisition culture offers an explanation for why problems with weapon acquisitions persist despite numerous attempts at reform. Reforms, in essence, have championed sound management practices, such as realistic estimating, thorough testing, and accurate reporting. These practices, while having improved acquisition management, have not been widely adopted because they run against the grain of, or are at least indifferent to, the very basic and strongly reinforced incentives to field weapons. In contrast, practices not normally viewed as good management techniques—such as concurrency and unrealistic estimates—comprise an effective stratagem for fielding a weapon because they reduce the risk that the program will be interrupted or called into question. By default, many improvements reformers have sought have become the domain of “outsiders” such as regulators, overseers, and critics. Thus, not only are reforms often at cross-purposes with the basic drives of the acquisition process, their eventual position as external controls can reinforce the optimism, parochialism, and protectionism endemic to the process.

Reforms Have Battled the Same Issues for Years

It has almost become a cliché to state that the numerous reforms initiated over the years have not had the desired effect and that today we face the same array of acquisition problems. The success of “reforms”—defined in the larger sense of laws, DOD regulations, outside panels, and recommendations from independent agencies—has been limited not because these reforms embodied bad ideas or focused on the wrong issues. To the contrary, reforms have generally been aimed at correcting the most well recognized acquisition problems, including making cost estimates more realistic, reducing the time and cost of acquiring weapon systems, reducing duplication, enhancing program stability, improving the quality of the acquisition work force, and putting better information in the hands of decisionmakers when they need it.

The historical frustration of reform can be seen in the action-reaction manner in which reforms have attempted to bridle the same set of problems over the years. For example, two premier reforms arose in response to the problems experienced on the C-5A transport acquisition. These were DOD’s major acquisition regulations and Office of Management and Budget Circular A-109, which together embraced the “fly before buy” concept and implemented the milestone decision approach to acquisitions. The C-5A program experienced significant cost and schedule growth and serious performance problems that took years to correct. These problems were attributed to the over-specification and inflexibility of performance requirements, the underestimation of technical risks, selection of the

lowest but not most cost-effective contractor proposal, excessive concurrency, and an overreliance on fixed-price contracts to manage a sophisticated development effort. Ironically, the strategy used to acquire the C-5A—referred to as “Total Package Procurement”—was itself an attempt to reduce cost overruns, instill greater competition, assign the contractor total responsibility for the design, and prevent contractors from “buying into” programs by submitting artificially low bids.

Additional major acquisition reforms have sought to reduce cost and schedule overruns, to increase program stability, to emphasize realistic testing, and to improve the efficiency of the acquisition process. These reforms—which stretch back to the McNamara initiatives of the early 1960s—have more recently included the 1981 Defense Acquisition Improvement Program, the 1983 Grace Commission reports on DOD, the 1986 Packard Commission report, the 1986 Goldwater-Nichols Act, and the 1989 Defense Management Review.

Figure 4.1: Key Acquisition Studies and Reform Initiatives

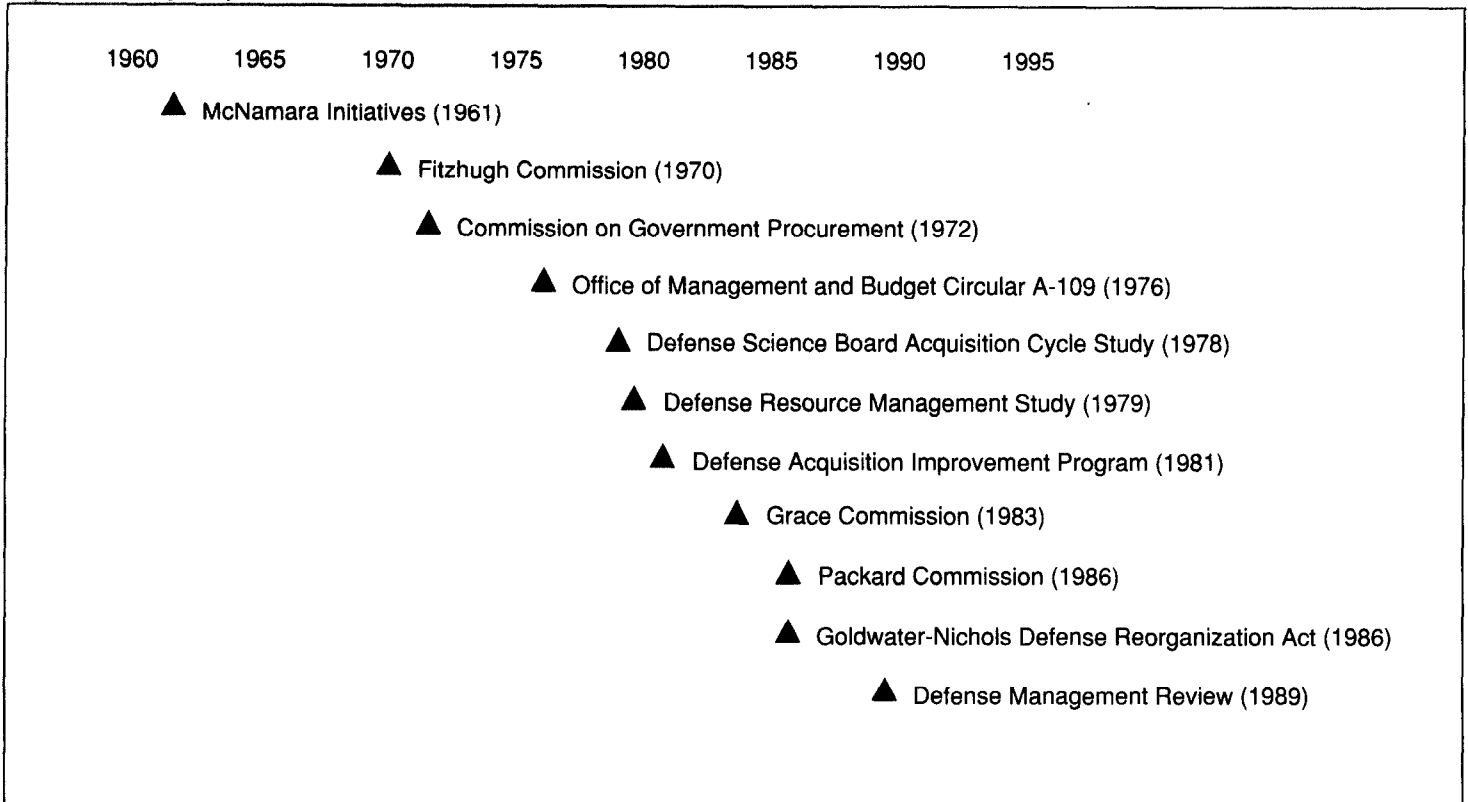

Despite the more recent initiatives, in the late 1980s and early 1990s, familiar acquisition issues arose, such as the performance and concurrency of the B-1B and B-2 programs and the belated discovery by DOD of significant cost overruns on the A-12 aircraft, which was being developed under a fixed-price contract.

Inability to Change the Culture Has Thwarted Reform

Proposals to correct problems have run the gamut of adding controls, increasing management layers, streamlining, and decentralizing. While reforms have had some success in correcting problems and emplacing a system of checks and balances, we have found that after initial enthusiasm, support for a reform wanes. We believe that acquisition reforms have had limited effectiveness because they have not changed the basic incentives or pressures that drive the behavior of the participants in the process. Reforms have also suffered because of acquisition executives' limited ability to effect cultural change.

Reform Initiatives Have Not Caused Cultural Change

Reforms have often sought coercive, procedural, and organizational solutions to make things happen without necessarily affecting why they did not happen in the first place. For example, there have been recommendations aimed at improving the realism of cost estimates, but these are hard to implement when the acquisition process itself does not reward realism. The confrontation of reforms with, or their indifference to, the acquisition culture can be illustrated by examining a few familiar reform measures: streamlining, “fly before buy,” and baselining.

Streamlining: Several initiatives have sought to improve program efficiency and realism by streamlining and decentralizing the management of acquisition programs. The 1981 Acquisition Improvement Program called for the delegation of many program decisions from the Secretary of Defense level to the service level, with the intention of reducing “micromanagement.” Similarly, the 1986 Packard Commission recommended a three-tiered organizational structure for acquisitions within each service that would reduce bureaucratic layers while clarifying responsibility and accountability. This structure was intended to reduce the tendency of program managers to be program advocates and thereby increase the flow of realistic information to senior executives.

These reform measures have not ensured that more realistic program information is brought forward in a more timely manner. For example, critical information about the status of the A-12 aircraft program was withheld by the Navy at the time of DOD’s 1990 major aircraft review. The underlying cultural pressures that cause such information to be optimistic in the first place have not changed. The fact remains that optimistic information helps a program proceed, while negative information can hurt a program. Moreover, a primary source of program information is program sponsors, who are conditioned to be proponents of the program. Streamlining or delegating decisions may make the process more efficient, but it will not necessarily lead to different outcomes if the same set of incentives guides decisions. In fact, biases could become stronger if decisions involve fewer individuals whose livelihoods are more exclusively tied to the success of weapon programs.

“Fly Before Buy”: This practice generally refers to building and operationally testing prototypes of a weapon to ensure that the weapon will work as promised before major production commitments are made. Besides minimizing problems in production, this practice is intended to provide decisionmakers critical information on system performance and risk so that more informed decisions can be made. “Fly before buy” has

been supported by public law, DOD regulations, the Packard Commission, and the Defense Management Review. We have been a strong supporter of conducting sound operational testing early enough in the acquisition process to support production decisions and have issued numerous reports on the issue.¹ Such testing has also been institutionalized in the form of operational test and evaluation agencies in each of the services and a directorate in the Office of the Secretary of Defense. Yet concurrency in programs—whereby such testing is conducted after production has started—is a persistent acquisition issue, as evidenced by dramatic test results on the C-5A, Sergeant York, B-1B, the Advanced Medium-Range Air-to-Air Missile, and the Airborne Self-Protection Jammer programs after production had begun.

The “fly before buy” approach to testing is not resisted because it is unsound or because program sponsors have an affinity for increasing technical risks. Rather, sponsors’ resistance to testing is a logical reaction to the additional time and up-front cost required and to the reality that testing can jeopardize programs. This is particularly true of operational testing because it occurs outside of the program manager’s control, exposes the weapon to harsh operating conditions, and poses the threatening question of whether the weapon can reliably execute its mission as advertised. Moreover, although testing is intended to be a constructive tool, it tends to become a report card that surfaces problems at a time when little can be done about them without great effort. In fact, it is not unusual for these problems to be discoveries of latent design flaws that should have been caught earlier in the process. Tests represent key opportunities for independent organizations to obtain critical program information and can become a lightning rod for debating a program’s merits. Thus, the rational use of test results to challenge a program evokes program sponsors’ rational aversion to testing.

The bottom line is that one of the best ways program sponsors can insulate their program from the perils of the acquisition process is by adopting a strategy of concurrency, not “fly-before-buy.” As they see it, the threat of program disruption is a strong incentive for getting the production line started before data from the final phases of testing and evaluation are available. Problems can be smoothed out as production proceeds, they reason. Conversely, if production start-up is delayed until deficiencies are corrected, the program may become stigmatized, inviting critics and budget cutters to converge on it. Thus, while concurrency

¹For further information, see Weapons Testing: DOD Needs to Plan and Conduct More Timely Operational Tests and Evaluation (GAO/NSIAD-90-107, May 17, 1990).

poses risks that run counter to sound management, it appeals to the stronger motives of gaining commitment to a program before negative information can become available. It is the surest way of fielding the weapon without interruption.

Baselining: This is a technique aimed at enhancing program stability, whereby a program office “contracts” with top management to develop a system that meets basic performance, cost, and schedule requirements in exchange for stable funding and minimal interference. This approach was embraced by the Air Force’s 1983 Affordable Acquisition Approach study and the Packard Commission and is related to the milestone authorization of “Defense Enterprise Programs” called for in 1986 legislation. In theory, baselining makes sense, but it has not met with great success in practice for two reasons. First, the guarantee of stable funding and noninterference requires that all acquisition participants commit themselves to multiyear funding. This is a particularly difficult commitment for the Congress because it requires that the Congress yield some of the power of the annual authorization and appropriation process. While the Congress has been willing to provide multiyear funding for mature programs in production, it has been reluctant to do so for weapons in development.

Second, the existence of baselining agreements or even stable funding does not ensure that estimates of performance, cost, and schedule will be more realistic or attainable. In recommending baselining as a good way to promote stability, the Packard Commission cited the B-1B as an example of a baselined system. Despite enjoying stable funding and congressional support, the B-1B has since experienced significant performance shortfalls and now requires large sums of additional funding to correct these and other problems. From the standpoint of the acquisition culture, however, the B-1B was successful at a very basic level: it proceeded through development and fielding with little interruption. Similarly, the F-117A program experienced many common acquisition problems despite stable funding, continuous congressional support, and streamlined management. In January 1991, we reported that the F-117A—highly concurrent to achieve early fielding—had experienced schedule delays, cost increases, substantial modifications, and several years of substandard readiness rates (B-238891, Jan. 11, 1991).

In the final analysis, the objective of baselining—stability—has to be viewed as an essential ingredient to a successful program. Conversely, destabilizing a program by altering performance requirements, funding availability, or schedules is almost certain to cause problems. However, in

view of the many pressures that characterize the acquisition culture, stable funding and support will not prevent other acquisition problems, such as problems stemming from oversold performance requirements and highly concurrent schedules. In short, successful programs enjoy funding stability, but funding stability does not ensure program success.

Ability of Executives to Effect Change Is Limited

The short tenures typical of high-level DOD acquisition executives make it difficult for them to change the system of incentives because other participants can wait out reforms they oppose. Even when acquisition executives take firm stands to restrict specific programs, such as to deny funding, they do not have the power to make their decisions stick. For example, executives' decisions can be overturned by congressional participants who support the program. Such has been the case with the Marine Corps' AV-8B Harrier and V-22 Osprey programs. In each case, the Secretary of Defense excluded the programs from DOD's budget request, believing they were not the most cost-effective solution to the mission need. Congress, however, agreed with the Marine Corps' professed need for the new systems and provided funding.

Attempts by acquisition executives to obtain realistic information on weapon programs from the military services have also met with limited success. In 1990, we reported that to protect programs from criticism, the services were reluctant to provide the Office of the Secretary of Defense current program information, such as updated cost estimates.² In fact, top-level acquisition participants' demands for better program information can intensify the protectionism of program sponsors. For example, in January 1992, a panel of the National Academy of Public Administration reported that congressional demands for DOD to certify cost, performance, and reliability information on the Advanced Medium Range Air-to-Air Missile program during the 1980s had instead yielded higher levels of unreliable information.³ Similarly, as mentioned earlier, a demand that programs be affordable may be more likely to result in a less realistic cost estimate than in an affordable program.

²Defense Acquisition: Perspectives on Key Elements for Effective Management (GAO/NSIAD-90-90, May 14, 1990).

³Beyond Distrust: Building Bridges Between Congress and the Executive, a report by a Panel of the National Academy of Public Administration, Jan. 1992.

Most Recent Initiatives Offer Promise

DOD officials believe that the Defense Management Review initiatives of 1989 and other actions the Office of the Secretary of Defense has taken in the past 2 or 3 years will address many acquisition problems. These initiatives include increased acquisition training, more independent cost analyses, and revisions to acquisition regulations that emphasize a technical, event-based approach to acquisition management. This approach includes a major effort to rigidly discipline the establishment and fulfillment of milestone criteria before permitting a major weapon program to proceed to the next phase of the acquisition process (see fig. 1.3).

Such an approach might have been evident in a 1992 Office of the Secretary of Defense assessment of an acquisition strategy proposed by the Strategic Defense Initiative Organization. The critical assessment of the strategy proposed for ballistic missile defenses appears to have been instrumental in the decision to reduce risks in the strategy and missile deployment dates.

Other initiatives have cited the need for incentives within the process that will motivate the individual services and weapon program offices to, on their own initiative, adopt more reasonable program objectives and to be more candid about the status of their programs. In 1988, the Project on Monitoring Defense Reorganization concluded the following:

In the end, the success of reform will depend on the commitment, the skills, the leadership, and the dedication of the people that make up the defense establishment. Very often the individuals understand the steps necessary to make the [Defense] department more efficient, but they lack the incentives to 'do the right thing.'

Similarly, the intent of the Packard Commission recommendations was to nourish a new acquisition culture within DOD so that decisions on purchasing major weapon systems would be based on realistic program information. The extent of improvement in weapons acquisition that will result from these most recent initiatives will not be known for several years. It takes years to develop a weapon, and because changes can be difficult to implement in ongoing programs, it may be 5 or more years before tangible improvements begin to be recognizable in new programs. We believe the success of these efforts will depend on the cultural changes as well. The delayed disclosure of significant cost overruns on the A-12 illustrates the difficulty of implementing change within the existing culture.

Opportunities for Change

For quite some time, a broad consensus has existed that weapon acquisition problems are serious and their resolution is overdue. The fact that such problems persist despite this consensus and despite years of reform underscores their resilience. As a practical matter, it must be recognized that total elimination of problems is not an attainable goal. Some level of acquisition problems is to be expected, given the risks and complexities of weapon system programs. Similarly, it is not reasonable to expect that a particular reform or action will be the ultimate solution. Rather, the goal of improving acquisition outcomes is one that requires continuous effort.

In keeping with this goal, we believe it is an opportune time to look at acquisition problems from a different perspective. On the one hand, there are problems that are caused by inadequate training, lack of experience, poor technique, and the like. It would be proper to classify these kinds of problems as mistakes, errors in judgment, and unforeseen obstacles. On the other hand, there are those problems that occur not because they are inadvertent, but because they are encouraged. For example, while some problems in cost estimating are due to flaws in methodology and to unforeseen technical problems, the more pervasive problem is lack of realism. Such undue optimism does not occur by chance or because estimators lack know-how, but because it helps programs gain approval and survive. It is the latter problem—symptomatic of the culture—that acquisition participants must also confront if they truly want better program outcomes. The opportunities afforded by the dissolution of the Soviet threat open the door to making needed changes; declining defense budgets demand them. By themselves, however, even these compelling reasons may not be enough to uproot an acquisition culture whose system of incentives has become self-sustaining.

This report does not present the answers; there are no easy ones. However, in the following pages we pose challenges, in the form of questions, we believe can help acquisition participants change the incentives—and the culture—of weapons acquisition. These views necessarily involve judgments and are subject to debate. However, the specifics of these challenges should not overshadow their general intent, which is to spotlight the acquisition culture as a proper focus of prescriptions.

Acquisition participants hold the key to cultural change since they largely determine the motives and incentives of the acquisition process. The first step toward such change is for the acquisition participants to accept their

collective responsibility for the incentives that drive the process, rather than to place blame on individuals or procedure.

Are Participants Willing to Make Sacrifices to Achieve Better Outcomes?

While much debate and reform have centered on the “how” of acquisitions (procedures and control) and the “who” (organization), a cultural focus must address the “why”—the motivations and incentives that affect behavior. In this vein, the key “problem” with the acquisition process may be that it does such a good job of meeting the diverse needs of its participants. This seeming contradiction is consistent with the predominant outcomes of the acquisition process. Over the years, we have observed that, while a small number of systems reach the field as unqualified successes and a small number are canceled, most weapons reach the field but cost more, take longer, and are harder to produce and support than expected. Generally, these weapons represent a significant improvement over those they replace, but it is not uncommon for them to have performance shortfalls or to require expensive, time-consuming modifications to achieve the required performance. Even special access, or “black” programs, although subject to less public scrutiny, have similar outcomes.

It is the consistency of these outcomes—and their imperviousness to reforms, contract types, contractors, acquisition strategies, weapon types, critics, military services, administrations, and Congresses—that leads to a conclusion that the acquisition process may be producing what the participants collectively want or are willing to settle for.

Instead of pointing the finger at individual participants, one must keep in mind that they do not act irrationally or with bad intentions. Rather, they do what they believe is right, given the pressures they face. The difficulty lies in the fact that there is no consensus on what is right. In the absence of such a consensus, the acquisition process serves to satisfy the diverse needs of its participants within the umbrella of providing U.S. forces with the best weaponry. In so doing, the incentives of the process—both positive and negative—favor maximizing programs. Parochialism, optimism, protectionism, and information hoarding are pragmatic responses to these incentives, while cost growth, schedule delays, duplication, and performance problems are the logical consequences.

Ultimately, predominant program outcomes are consistent with this set of incentives. If better program outcomes are desired and persistent acquisition problems are to be alleviated, then the motives and incentives

that drive the participants and the process must be realigned to produce such outcomes. The challenge lies in the fact that better outcomes will require participants to give up something—to ask the acquisition process to satisfy fewer needs. If there is to be less duplication among programs, more achievable objectives, and more candor about results, then there will have to be fewer programs, smaller ones, and/or programs with less ambitious requirements. The question is whether participants are willing to make the sacrifices needed to achieve these outcomes.

Are Participants Willing to Recognize the Broader Consequences of Individual Actions?

A powerful influence on the behavior of program sponsors and skeptics is their perception of “what works.” Thus, it is the actions taken on individual programs that define incentives and motives more than what is prescribed on paper. Within the current process, compelling circumstances can make a case for taking actions on individual programs that would otherwise contradict policy or compromise sound principles. Yet it is these individual actions—not policy—that communicate the broader message of “what will work” to others in the process.

For example, a decision to approve a program—such as the Airborne Self-Protection Jammer—for production despite incomplete development may be right for the program, but it sends the message to other programs that concurrency and skirting test criteria are acceptable. Similarly, when the Secretary of Defense takes the difficult stand to disapprove a program, a decision by the Congress to restore it tells program sponsors that such decisions can be overturned. The difficulty lies in the fact that when looked at individually, circumstances can almost always make a compelling case in favor of the program at hand. Thus, on a case-by-case basis, decisions to approve programs despite their potential duplication, known problems, or their failure to live up to advertised expectations can be rationalized in a number of ways: there is an urgent threat to be met; a warm production base needs to be maintained; despite shortfalls, the new system is more capable than the one it is replacing; the new system’s problems can be fixed later.

While we do not advocate the blind application of policy to all circumstances, we do believe that decisions—whether by DOD or the Congress—to approve programs that embody problems reinforce those problems. Thus, if duplicative programs are approved despite an acquisition policy to the contrary, the message to other program sponsors and skeptics is that duplication is acceptable. The challenge for acquisition participants, particularly for those with program approval authority, is to

treat individual program decisions as more than the case at hand. They must weigh the broader implications of what message these decisions send to other participants regarding what is acceptable or “what will work.”

Will Participants Agree to a Military Strategy Before Making Major Acquisition Commitments?

The defense acquisition decisions made over the next few years will be especially critical because they are intertwined with the rewriting of national security policy and military strategy. Decisions on next-generation weapons will define solutions to defense policy needs, dictate budgets for the remainder of the decade, and, in the process, either take advantage of or miss the opportunity to improve the acquisition culture. While much debate will continue to center on potentially dramatic changes in the level of spending and the number of new weapon programs to be funded, these changes will not necessarily lead to better outcomes on those programs that survive. In fact, problems on individual weapon programs could worsen if the intensified competition for funds, prompted by the reduced threat and declining budgets, leads to increased optimism as a tactic necessary for program survival.

While DOD has revised the military strategy, congressional debate on issues such as roles and missions suggests that a consensus has not been reached. Long-term dividends could result if the Congress and the administration refrain from making weapon system milestone decisions until they agree on a military strategy, including how and where U.S. forces should be prepared to fight; how the forces should be structured to accomplish national security objectives; and how to preserve the research, technology, and industrial base. These should be explicit choices; they should neither be dictated by individual program decisions, nor should they be the tenuous byproduct of budget compromises. With an agreed-upon strategy, consensus on the roles and missions of the services could be more easily reached, and weapon programs could then be the result of clear decisions on how to implement policy, rather than the result of incremental decisions that assuage individual interests.

Can Incentives Be Changed to Discourage Optimism, Parochialism, and Protectionism?

The preceding challenges, if collectively accepted by acquisition participants, could lay the groundwork for cultural change. The following are more specific suggestions to further institute such change. Because a discussion of culture necessarily involves motives, beliefs, and perceptions, more specific suggestions can and should evoke closer debate. Regardless of the specific actions participants take to effect change, we believe the objectives should be twofold: (1) to uproot

traditional seats of parochialism and self-interest and (2) to enforce a set of incentives—both positive and negative—to motivate participants to take actions that are consistent with better program outcomes.

The Authority for Determining Program Needs

To reduce the parochialism currently inherent in program justifications, the determination of needed capabilities and the particular types of weapons to fill those needs should not be left with individual branches and warfare communities within the services. The parochial and duplicative outcomes of the acquisition process are consistent with the fact that system requirements mirror the traditions and self-preservation instincts of their sponsoring organizations. Moving this authority higher up in the DOD organization could enable competing demands, available resources, and the needs of theater commanders to be more fairly assessed before a specific program need is given life. There is not necessarily a “right” answer as to where the authority for determining program needs should be revested. Possibilities include an enhanced Joint Requirements Oversight Council, which currently reviews program requirements; the Defense Planning and Resources Board, which was established to help develop stronger links between national policies and the resources allocated to specific programs and forces; the Office of the Secretary of Defense; or perhaps a high-level council/board within each service, following any realignment of their roles and missions. It is also important that if a debate is to occur between DOD and the Congress over the need for a weapon, it should occur early in the process before the weapon gains too much momentum.

The Need to Oversell Programs on the Basis of Top Performance and Urgency

The dissolution of the Soviet Union, together with the current U.S. inventories of highly capable weapons, represents opportunities to abate the need to oversell weapon programs, the associated optimism in cost and schedule, and the tendency to weaken acquisition strategies in favor of schedule acceleration or preservation. DOD has made several proposals along these lines, including limiting or terminating production plans for several major weapon systems and reducing concurrency in new programs. However, these changes will not necessarily produce better program outcomes if overselling performance and urgency still “work” in gaining program approval. Defusing the need to oversell programs on the basis of performance and urgency may involve several steps. First, top-level decisionmakers in DOD and the Congress should agree to a policy regarding “what will work” that is consistent with desired outcomes. For example, if the national security strategy suggests less need for

revolutionary performance gains on future weapons, then an acquisition policy could emphasize—and thus create incentives for—programs whose technical advances are aimed at reducing duplicative systems and support costs.

Second, individuals with pertinent technical expertise and knowledge of the state-of-the-art of key technologies available, including those in the commercial sector, should be more involved in defining the specific performance required of a weapon system. Such discipline could better balance the reasonableness of performance requirements against their cost, risk, and value. According to DOD officials, more of this type of analysis is being done. Infusing such expertise into requirements definition could be facilitated if the authority for determining requirements were moved, as discussed earlier.

Third, and perhaps most important, decisionmakers must ensure that their decisions on individual programs are consistent with their desire to discourage the overselling of programs.

Other pressures that influence the justification of weapon systems could also be relieved through up-front policy agreements among acquisition participants. For example, it may be preferable to declare and pursue a policy of replacing some major platforms on a set schedule rather than tying the need for their replacement primarily to performance advancements. Also, as the defense industrial base recedes in response to smaller budgets, it may make sense to develop a list of critical capabilities and facilities—including those to be provided in-house, by contractors, and by universities—that need to be preserved in the interest of national security. If an acquisition program is justifiable as an effective means of preserving a critical industrial capability, this justification should be candidly debated at the outset to relieve the program manager of the need to oversell.

When to Define Programs

Carrying research and development efforts further before incorporating them into specific weapon programs could reduce the tendency to overpromise expected results. With the traditional emphasis on high performance, weapon programs have, out of necessity, relied on risky technology development efforts. Such efforts, when drawn into a major program, not only become dedicated to the program but are subjected to the same requirements for precise cost and schedule estimates, even though their immaturity defies such precision. Moreover, test results from

such efforts, like test results in general, are used by proponents to help market the program and by opponents to criticize it. The former Under Secretary of the Army has cited such premature program definition as a major cause of turmoil in the Comanche Light Helicopter program.

Freeing research and technology efforts from program association until they mature to a specified level, such as the demonstration and validation phase, could be one element of an overall strategy to ensure that the nation nurtures a healthy research and technology base in the face of declining weapons production. Given sufficient funding, the efforts themselves would benefit because they would be more able to explore the full range of results, rather than being directed toward meeting program-specific goals. Under these circumstances, testing could assume a “no fault” nature, whereby its main and proper purpose would be to gauge and guide the progress of the work. In this arena, test failures, problems, and redesigns would be part of a healthy process, whereas the same results now represent potential disasters in major programs.

When the need for a major program is determined, the program could “cherry pick” from mature research and technology projects, reducing the subsequent risks to the program. In addition, the testing of a major weapon could then be more properly focused on “how well” it performs, rather than on “whether” it will perform. Many of these ideas are already embodied in DOD’s new acquisition strategy, which calls for greater demonstration of advanced technologies, to prove their feasibility and producibility, before incorporating them into new or ongoing acquisition programs. The success of this strategy will depend on the cooperation of all acquisition participants.

Financial Realism

In the private sector, realism is essential to a responsible individual’s solvency and to a commercial enterprise’s profitability; undue optimism has direct and dramatic consequences. Conversely, in weapon acquisitions, optimistic cost estimates are rewarded because they help gain program approval, win contract awards, and attract budgetary income. The consequences of cost growth are not directly felt by an individual program because they are “accommodated” through stretch-outs and quantity changes and by spreading the pain across many programs.

To discourage unrealistic cost estimates, the consequences should be tied back to the program at hand. Such incentives could work the other way as

well—programs that are well-managed within estimates should be undisturbed and should keep at least a portion of any cost savings they can achieve. One approach would be to require an up-front determination of how much money can be afforded for a new program, bounded by a range that reflects uncertainty. That is, the range of costs should be wider early in a program when uncertainty is greater and narrowed as the program matures. This having been done, subsequent cost increases would have to be absorbed by the program itself, either in the form of reduced quantities or reduced capabilities. The idea is not to overemphasize discipline to the extent that valid unanticipated needs cannot be accommodated. However, such accommodations should be the exception; they are currently the rule.

The Future Years Defense Program can be used as a tool to help decide how much money can be afforded for an individual program and to confront the consequences of program cost growth. The Future Years Defense Program could force the arrangement of programs so they fall within reasonable funding levels. The timing of major programs could be staggered to reflect financial realities. Without some actions along these lines, DOD could, in the future, be faced with a financial “bow wave” of next-generation weapons—a condition that can bring out the worst in acquisition management. The funding plan could also serve to discourage other sources of program cost growth, including requirements increases and program redirections. When any participant—including the Congress—proposes an action that will change the funding profile or timing of a program, that participant should also propose the trade-offs in the plan that will make the action fiscally possible.

A final step in the arena of financial incentives could involve the timing of budget requests. Currently, budget requests must often presume outcomes from future program events. For example, the budget request for a program scheduled for operational testing in November 1993 and a production decision in April 1994 must be submitted to Congress in January 1993. To meet this budget submission date, the program manager must actually develop an individual program budget request in early 1992 for review and approval within DOD. Not only does this sequence of events force the program manager to spend a lot of time defending the budget request absent critical information, but it also provides more incentive to push the program through the events to save the budget. To relieve this pressure, consideration should be given to having budget requests that implement major decisions follow—not precede—those decisions.

Aligning Career Success With Better Program Outcomes

One of the aspects of the acquisition culture that will be most difficult to change is the fact that the success of participants' careers is more dependent on getting programs through the process than on achieving better program outcomes. The success of cultural change will depend on whether participants are rewarded for taking actions that produce better outcomes. We believe the challenges discussed above can provide some of those rewards. It is also possible that program managers' careers could be aligned with better outcomes if their progression is governed by the quality of their management and not the survival of their programs.

However, the picture is less clear for other participants. For example, DOD acquisition executives are critical to cultural change because of their control over large numbers of programs and because they are in a position to enforce a set of incentives within DOD that rewards better outcomes. However, they do not necessarily stay in their positions long enough to develop the needed long-term perspective or to effectively change traditional incentives. Moreover, their decisions can be overruled through the cooperative actions of other participants. Similarly, it is difficult to envision Members of Congress being relieved of pressures to support programs that benefit their constituents, despite efforts to change the culture.

At this point, perhaps the most important step participants can take is to recognize the broader implications of their individual actions. In July 1992, the Chairman of the Senate Armed Services Committee called for an overhaul of military roles and missions. To make the difficult choices necessary in such an overhaul, he suggested that the standard should be "what is best for America," not what is best for the individual services. This standard should govern the actions of weapons acquisition process participants at all levels as well.

The Prospects for Change Are Encouraging

We have, over the years, taken the position that strong central management on the part of the Office of the Secretary of Defense is essential to acquisition reform. Such management is crucial now, given the significant future consequences of the decisions being made. Once a healthier culture is established, the need for centralization may eventually be lessened. Although we often disagree with DOD on acquisition matters, we believe that the top management in the Office of the Secretary of Defense and the Joint Chiefs of Staff has displayed the ability and conviction to forge significant change. They have also done much to reestablish central management of weapon acquisitions. In addition to

DOD's recent reform initiatives, these characteristics have been manifested in a number of ways, including

- the strong collective leadership of the Secretary of Defense and the Chairman of the Joint Chiefs of Staff during Operation Desert Storm;
- DOD's proposal to trade off weapon programs in favor of military personnel in an effort to make an orderly transition to a smaller force;
- more realistic funding projections, coupled with an announced firm stand not to allow programs to proceed if they are shown to be unaffordable in the future; and
- renewed commitment to the Packard Commission's recommendations and to improving the quality and professionalism of the acquisition work force.

The Congress has also taken constructive actions and made proposals to improve weapon acquisitions. For example, the Joint Chiefs of Staff was strengthened by the Goldwater-Nichols Act, enabling it to function more effectively in situations such as Operation Desert Storm. Both the Senate and House Armed Services Committees have been forthright in highlighting the need for a new military strategy in light of the reduced threat and have put forth proposals on such a strategy. The Senate Armed Services Committee has pioneered efforts to authorize funding for entire acquisition phases, so as to reduce program instability. More recently, Members of Congress have proposed renewed emphasis on the "fly before buy" policy in weapon programs and a civilian acquisition agency to reduce the acquisition bureaucracy and make program management more effective.

Today, the ingredients for making lasting improvements to weapons acquisitions—the need, the opportunity, and the leadership—exist. To convert these ingredients into constructive change will require both the Congress and the administration to take joint ownership of repetitive acquisition problems and to take explicit steps to resolve them. The actions already underway are important to better outcomes. Also important, in our view, is the recognition of the cultural dimension of acquisition problems and the solutions it suggests. Beyond directives and controls, acquisition participants will have to pull together to make better outcomes the more natural products of a healthier acquisition culture.

Examples of Weapon System Acquisition Issues Reported by GAO From January 1978 Through September 1992

Table I.1 provides a brief overview of weapon system issues we have identified over the past 15 years.

Table I.1: Weapon System Programs and Issues

	Army
Is the system the best solution to the mission need?	<ul style="list-style-type: none"> - Terminal Guidance Warhead - Armored System Modernization program - Dragon II antitank weapon - Air Defense Antitank System - Apache attack helicopter - Near-term Scout helicopter - Viper antitank weapon
Are the program cost and schedule estimates realistic?	<ul style="list-style-type: none"> - Javelin antitank system - Terminal Guidance Warhead - Comanche light helicopter - Air Defense Antitank System - Bradley Infantry Fighting Vehicle - Armored Systems Modernization program - Black Hawk helicopter - M-1 Abrams tank - Stinger antiaircraft missile
Can the program be executed with available funds?	<ul style="list-style-type: none"> - Comanche light helicopter - Apache attack helicopter - Armored Systems Modernization program
Is the program's acquisition strategy reasonable?	<ul style="list-style-type: none"> - Army Tactical Command and Control System - Air Defense Antitank System - Comanche light helicopter - Special operations forces helicopter - M-1 Block II tank - Armored Systems Modernization Program - Sergeant York Division Air Defense gun
Has it been shown that the system is operationally effective?	<ul style="list-style-type: none"> - Air Defense Antitank System - Bradley Infantry Fighting Vehicle - Aquila remotely piloted vehicle - Sergeant York Division Air Defense gun - Viper antitank missile - Copperhead projectile - Standoff Target Acquisition System - Bigeye bomb
Is the system suitable for production and fielding?	<ul style="list-style-type: none"> - Air Defense Antitank System - Apache attack helicopter - Aquila remotely piloted vehicle - Patriot air defense system - Copperhead projectile - Stinger antiaircraft missile - Black Hawk helicopter

**Appendix I
Examples of Weapon System Acquisition
Issues Reported by GAO From January 1978
Through September 1992**

Navy	Air Force
<ul style="list-style-type: none"> - Radar jammers - V-22 Osprey tiltrotor aircraft - AV-8B Harrier aircraft - Rapidly Deployable Surveillance System - Expendable Reliable Acoustic Sonobuoy - Advanced Signal Processor - Tactical towed array sensor systems 	<ul style="list-style-type: none"> - Milstar communications satellite - Radar jammers - Sensor Fuzed Weapon - Advanced Warning System - Tactical Air Navigation System - U.S. Antisatellite Program - Over-the-Horizon Backscatter Radar
<ul style="list-style-type: none"> - V-22 Osprey tiltrotor aircraft - Arleigh Burke DDG-51 destroyer - AOE-6 fast combat support ship - Rolling Airframe Missile - Sea Lance missile - F/A-18 fighter - NAVSTAR Global Positioning System - AV-8B Harrier aircraft - Light Airborne Multi-Purpose System MK III 	<ul style="list-style-type: none"> - Short-Range Attack Missile II - Advanced Tactical Fighter - C-17 airlift aircraft - F-117A fighter aircraft - Advanced Medium Range Air-to-Air Missile - B-1B and B-2 strategic bombers - EF-111A aircraft - U.S. Antisatellite Program - Low Altitude Navigation and Targeting Infrared System
<ul style="list-style-type: none"> - Seawolf SSN-21 submarine - Arleigh Burke DDG-51 destroyer - Light Airborne Multi-Purpose System MK III 	<ul style="list-style-type: none"> - B-2 strategic bomber - Peacekeeper missile - Small Intercontinental Ballistic Missile - U.S. Antisatellite Program
<ul style="list-style-type: none"> - Seawolf SSN-21 submarine - Arleigh Burke DDG-51 destroyer - Rolling Airframe Missile - MK-48 and MK-50 torpedoes - Phoenix AIM-54C missile - F-14D fighter aircraft - Captor Ocean Mine System 	<ul style="list-style-type: none"> - B-1B and B-2 strategic bombers - C-17 airlift aircraft - Peacekeeper Rail Garrison missile - Advanced Cruise Missile - Advanced Medium Range Air-to-Air Missile - F-117A fighter aircraft - ACU-130 gunship
<ul style="list-style-type: none"> - Rolling Airframe Missile - MK-48 and MK-50 torpedoes - Tomahawk Land-Attack Cruise Missile - AV-8B Harrier aircraft - F-14D fighter aircraft - NAVSTAR Global Positioning System - Surveillance Towed Array Sensor System - 8-inch Major Caliber Lightweight Gun 	<ul style="list-style-type: none"> - Small Intercontinental Ballistic Missile - Peacekeeper missile - B-1B and B-2 strategic bombers - JP-233 airfield attack system - Wide area antiarmor munitions - Precision Location Strike System - Low-Altitude Ballistic Missile Defense System
<ul style="list-style-type: none"> - V-22 Osprey tiltrotor aircraft - Electronic warfare test equipment - Phalanx close-in weapon system - High-Speed Anti-Radiation Missile - AV-8B Harrier aircraft - Tomahawk Land-Attack Cruise Missile - 8-inch Major Caliber Lightweight Gun 	<ul style="list-style-type: none"> - Electronic warfare test equipment - B-1B and B-2 strategic bombers - Advanced Cruise Missile - Advanced Medium Range Air-to-Air Missile - F-117A fighter aircraft - Peacekeeper missile

Following are discussions of several specific examples that illustrate each of the six issues. Neither table I.1 nor these examples are intended to be

all-inclusive. However, they are presented to illustrate how widespread the acquisition problems discussed in chapter 2 have been.

Is the System the Best Solution to the Mission Need?

In addition to the Sensor Fused Weapon program cited in chapter 2, other specific examples of programs, or mission areas, in which the need for the weapon system was in question or consideration of alternative solutions to mission needs was a key issue include the following:

- In June 1992, we reported on DOD's restructuring of the Milstar communications satellite program (GAO/NSIAD-92-121). In restructuring the program, DOD plans included adding a medium data rate capability to satellites number 4 and beyond. We noted that DOD had not demonstrated that this capability on Milstar would be the most cost-effective means of satisfying tactical communications requirements. Two less costly alternatives that meet requirements were identified in an October 1991 DOD study. One alternative was characterized as having moderate development risk (the same as the restructured Milstar), and the other as having high risk. The life-cycle costs for the moderate risk alternative was estimated to be several billion dollars less over a 20-year period than the restructured Milstar. For the high risk alternative, the 20-year life-cycle costs were estimated to be several billion dollars less than even the moderate risk alternative.
- In an April 1992 report, we discussed the acquisition of Army and Air Force weapons for the close support mission of attacking targets in close proximity to friendly forces (GAO/NSIAD-92-180). The identification of weapons to perform this mission is controlled by the military services, which generate their own mission needs assessments. These assessments have not questioned what and how much is needed; nor have they fully considered the expected contributions of other close support weapon systems. The consideration of alternative weapons to satisfy a mission need is generally limited to a single type of weapon. For example, the Air Force's 1990 assessment of how to replace the A-10 fixed-wing aircraft considered only other fixed wing aircraft—it excluded Army artillery systems and attack helicopters. DOD considers each type of close support weapon system to be "complementary" to the others and, therefore, all are necessary. The resultant acquisition decisions provide no assurance that DOD has selected the most cost-effective solutions to meet close support mission needs.
- In November 1991, we reported on DOD's plans to develop a follow-on system to the Defense Support Program, a strategic surveillance and warning satellite system (GAO/NSIAD-92-39). We cited five studies that

indicated the new follow-on system DOD was planning to develop may not be the most cost-effective solution to the mission requirements. Indications were that an upgraded system would provide most all of the capability needed at a significantly lower cost. The new system, as initially deployed, would also not be capable of fully meeting mission requirements, but would be designed to accommodate future enhancements to meet requirements. However, the incremental costs necessary to bring initial capabilities up to the full requirements had not been estimated by the Air Force. Study estimates indicated that when all costs were considered, the new warning system would cost about \$3 billion more than an upgraded system.

- Several of our reports over the past 10 years, including two classified reports, have identified an unwarranted proliferation of electronic warfare systems to protect aircraft against potential threat weapons.¹ For example, the Air Force and the Navy have 12 different radar jammers in use or being acquired at a cost exceeding \$9 billion to protect tactical fighter and attack aircraft against a common threat. None are used by both services. This proliferation has occurred despite DOD's commitment and long-standing congressional interest aimed at promoting commonality.
- In a classified March 1983 report, we recommended that the Air Force fully reassess the need to continue development and procurement of the Over-the-Horizon Backscatter radar system. The program included the development of four radar systems to provide a long-range tactical warning capability to help counter a threat of a Soviet bomber attack on North America. We pointed out that both the Air Force and the Navy were planning to develop better warning systems for the 1990s and that until those systems were available, existing airborne warning and control system aircraft could be used to strengthen tactical warning capabilities. The Air Force continued the program, which fell behind schedule and was terminated in January 1991, with two of the four radar systems having been delivered by the contractor. The program acquisition cost was about \$1.45 billion (in escalated dollars).
- In a classified 1981 report, we reported that the Army's Viper portable antitank missile would have only limited effectiveness against the threat it would face. We concluded that it should not be produced and recommended that other alternatives be examined. The Army decided to proceed with the Viper and awarded a production contract in December 1981. However, that same month the Congress directed the Army and the Marine Corps to test other available alternatives. These tests revealed that none of the alternatives, including the Viper, could

¹Navy/Air Force Still Developing Separate, Costly Radar Warning Receivers (GAO/NSIAD-87-167, July 1, 1987); Multiple Development of Costly Threat Simulators (GAO/NSIAD-88-93, Feb. 1, 1988); Electronic Warfare: Radar Jammer Proliferation Continues (GAO/NSIAD-92-83, Feb. 28, 1992).

effectively penetrate the frontal armor of modern tanks. The Army dropped its requirement for a light, portable antiarmor weapon, selected a Swedish system for further testing, and terminated the Viper production contract.

Are the Program Cost and Schedule Estimates Realistic?

In addition to our September 1991 report on cost and schedule overruns on missile systems, discussed in chapter 2, other reports on weapon system programs in which we cited cost and schedule issues as important problems or concerns include the following:

- In September 1992, we reported that the cost estimates for the DDG-51 shipbuilding contracts showed that the first three ships of this new destroyer program will total \$1.1 billion, double the original contract award cost estimates. As a result of major contract modifications and contract cost-sharing provisions, the Navy will pay for most of the increases. Officials of Bath Iron Works, the prime contractor for the lead ship, described to us in 1985 how their company had bid "aggressively" for the DDG-51 lead ship contract. The company believed its survival depended on getting Navy contracts for ships in the DDG-51 program, considering the lack of commercial shipbuilding in the United States.
- In September 1992, we reported that the acquisition cost estimate for the Army's Javelin antitank system had increased over \$1 billion since June 1989, a 33-percent increase (GAO/NSIAD-92-330). The increase was attributed primarily to (1) stretching out the production schedule from 6 to 10 years because of funding constraints and (2) technical problems that led to additional delays. We also reported that the cost of this 58,000-system program could increase further because the production cost estimate for a key component appeared optimistic.
- In several classified reports, the latest issued in July 1992, we cited problems on the Tri-Service Standoff Attack Missile program, including a high degree of concurrency, technical complexity, and highly optimistic plans and estimates. The cumulative effect of these problems has been program cost increases in excess of 50 percent, more than a 4-year growth in the development program, and a major restructuring of the fixed-price development contract. Development of this highly classified missile began in 1986.
- In April 1992, we reported that the C-17 transport aircraft development program, which included six production aircraft, was continuing to experience significant cost and schedule problems (GAO/NSIAD-92-205BR). Costs incurred by the contractor had exceeded the contract ceiling price with over 10 percent of the work remaining. The government's estimate of

the cost at completion was also continuing to increase and stood at \$7.45 billion, \$813 million over the contract ceiling. Additional increases have since occurred. One of the primary causes of the cost and schedule increases was the inability of the contractor to produce the aircraft at the levels of efficiency used in developing the contract estimates.

- In a classified December 1991 report, we discussed the President's termination of the strategic Short-Range Attack Missile II program in September 1991. We reported that at the time of termination, the program schedule had slipped about 4 years; the estimated unit cost had nearly doubled, from about \$0.8 million to \$1.4 million; and the quantity of missiles to be bought had decreased from 1,633 to 700. These changes were partially attributable to very serious development problems that affected the capability of the missile to accomplish its mission.
- The Navy's V-22 Osprey Vertical Lift Aircraft program has experienced both development delays and unit procurement cost growth. In an October 1990 report, we attributed this growth to changes in the program's structure, continuing development problems that could seriously affect the aircraft's performance, cancellation of production options, the Army's withdrawal from the effort, and the Air Force's reduced buy (GAO/NSIAD-91-45). As of April 1992, the full-scale development effort was about 3 years behind schedule. The estimated unit procurement cost had increased to \$32.5 million (fiscal year 1992 escalated dollars) and was expected to rise above \$40 million by time the aircraft was delivered. These high costs prompted the Navy in August 1992 to look into alternatives to the V-22 and to ask the V-22 contractors to design a lower cost version of the aircraft.
- In May 1984, we issued a report on the effectiveness of DOD's cost-estimating processes (GAO/NSIAD-84-70). The report was based on a review of the processes used on seven weapon system programs—the Apache helicopter, the Bradley Fighting Vehicle System, the Hellfire Missile, the Light Airborne Multipurpose Helicopter, Landing Ship Dock (LSD) -41, the T-46A Trainer, and the B-1B bomber. We found weaknesses in the cost-estimating guidance provided program offices and a need for more realism in the assumptions and methodologies used in preparing cost estimates. We found the use of overly optimistic assumptions in areas such as construction schedules and allowances for uncertainties. For example, in preparing the Hellfire production cost estimate, the Army had not performed an engineering risk analysis, despite known significant shortcomings in some major Hellfire components. We also found that DOD did not always thoroughly consider the recommendations of its independent cost groups in preparing program cost estimates. This happened, for example, on the Bradley program when an independent

estimate cited significant cost risks with the vehicle's fire control system. No change was made to the program estimate to reflect this risk. The following year the contractor's cost estimate for the fire control system rose \$336 million.

- In February 1982, we reported that the AV-8B Harrier program cost estimate did not include over \$1 billion in program costs—over \$700 million for trainer aircraft and over \$300 million for an on-board gun system (MASAD-82-19).

Can the Program Be Executed With Available Funds?

Specific weapon systems on which we have raised questions regarding the affordability of the program include the following:

- In April 1990, we reported that executing the Navy's 29-ship Seawolf submarine program within projected funding hinged on four optimistic assumptions: (1) a sustained shipbuilding and conversion budget growth of 3 percent above inflation, (2) a reduction in submarine construction time by more than 1 year, (3) congressional authorization for an average of three SSN-21s per year, and (4) no cost overruns in the program (GAO/NSIAD-90-163). A subsequent DOD major warship review recognized these inherent affordability problems, and as a result, the Secretary of Defense, in 1991, reduced the SSN-21 program to 12 ships to be procured over a 9-year period.
- In April 1987, we raised several concerns over the affordability of the Air Force's plan to modernize and expand its tactical fighter force from 36 to 40 wings (GAO/NSIAD-87-121). The plan was premised on the assumptions that defense spending's real growth would continue and that the share of the Air Force budget being allocated to tactical Air Force programs would increase. We pointed out that neither of these premises—which allowed for increased projections of available funds—was likely. Moreover, we noted that future tactical aircraft programs would be competing with high priority programs such as the C-17 cargo plane and the Advanced Technology Bomber (B-2) programs. The Air Force acknowledged these affordability concerns and delayed expansion of the tactical fighter wings.
- The Army's Comanche light helicopter program quantities have been significantly reduced over the years as a result of growing costs and limited funds. Originally, the Army had planned to buy 5,023 of these helicopters, at a peak production rate of 480 per year. In March 1987, we reported that quantities had dropped to 4,500 because of program cost increases (GAO/NSIAD-87-117FS). By June 1988, quantities had dropped to 2,096 as a result of additional cost growth, with a peak production rate of 216 per year. We reported in December 1988 that even this reduced

program did not appear affordable because available funding was sufficient for a production rate of only 157 per year (GAO/NSIAD-89-72). In 1990, the Army reduced program quantities again to 1,292 helicopters, with a peak yearly production rate of 120. In May 1992, we reported that because of the rising unit cost of the Comanche, dwindling defense resources, the diminished threat, and planned upgrades to other helicopters, the Army's requirements for this aircraft should be reassessed (GAO/NSIAD-92-204). The Secretary of Defense had earlier announced that DOD will concentrate on making small numbers of prototypes of the Comanche to develop the technology and capability. It will not automatically move into full-scale production.

Is the Program's Acquisition Strategy Reasonable?

Examples of weapons programs or reports in which either the overlap between development and production or the timing and quality of operational testing of the weapon system were concerns include the following:

- In August 1992, we reported on DOD's incremental development, testing, and fielding strategy for the Army's Tactical Command and Control System (GAO/NSIAD-92-151). Under this strategy, DOD planned to commit to production about \$1.8 billion in equipment for the system before ensuring that all five of the system's segments would work together as intended. DOD defended its acquisition strategy on the grounds that it provided the soldier with a usable segment of the system as it became available. The system, however, had been encountering continuous development problems and test failures. For the system to perform its mission, all five control segments had to be effectively integrated. The Army had already wasted \$155 million in premature equipment acquisitions for the system, and the urgency to field it vastly diminished with the dissolution of the Soviet threat.
- In March 1992, we issued a report on DOD's 1991 decision to continue production of the Navy's Airborne Self-Protection Jammer despite reliability problems because of a desire to avoid a break in production (GAO/NSIAD-92-103). In justifying this production decision, the Navy discounted certain software-induced failures, thus circumventing certain DOD testing standards and failing to recognize the adverse impacts of software problems experienced with other similar electronic warfare systems. For example, in July 1990, we reported that, because of software problems, the Air Force had to place improved ALQ-135 jammers produced for F-15 aircraft in storage rather than deliver them to tactical units (GAO/NSIAD-90-168). Again, in December 1987, we reported that

production began on a classified Air Force warning receiver before testing began. The Air Force later found that the performance of the receiver was worse than that of the receiver it was intended to replace. The Air Force continued to use the older warning receiver and to produce the newer receiver, only to place it in bonded storage pending redesign to solve the problem.

- In a May 1989 report on Navy testing, we disclosed that, as an alternative to the more realistic field testing of weapon systems in support of a decision to enter full-scale development or low-rate production, DOD was encouraging operational assessments based on modeling, simulation, or paper analyses (GAO/NSIAD-89-98). We reported that such assessments, while providing useful information in assessing the development status of a weapon, do not provide the realistic conditions generally needed to ensure accurate assessments for decision-making. In response to our report, which was based on a review of 19 Navy systems, the Congress enacted an amendment that excludes such operational assessments from the statutory definition of "operational test and evaluation."
- The Navy had to place Phoenix AIM-54C missiles in storage for extended periods of time pending design changes to solve problems with a critical missile component discovered during tests but not resolved before missile production began (GAO/NSIAD-88-104). At the time of our March 1988 report on the quality of the Phoenix, the Navy had already accepted delivery of over 500 nonfunctional missiles valued at about \$472 million. A Navy official at the weapons center overseeing development of the missile component told us the center had failed to adequately monitor the program because it "wanted the hardware out the door."
- In August 1987, we reported that DOD had approved initial low-rate production of the Advanced Medium Range Air-to-Air Missile despite knowing that the design was likely to change because many of the more demanding tests had not been completed (GAO/NSIAD-87-168). Performance and reliability problems were subsequently identified in testing, but, despite these problems, DOD approved production of additional missiles in 1988. These missiles required numerous modifications to the hardware and software to correct the reliability and performance problems found in the test program. These modifications placed an additional burden on the production program, which was already struggling and well behind schedule.
- In December 1986, we issued a report summarizing problems reported since 1970 on the quality of DOD operational test and evaluation (GAO/NSIAD-87-57). We reported that the usefulness of operational test and evaluation in estimating a weapon system's performance had been limited because of long-standing problems in test planning, test conduct, and the

reporting of test and evaluation results. For example, we had reported on 32 historical cases in which testing was unrealistic because it did not adequately replicate the operational environment; 25 cases in which test objectives, criteria, and plans were incomplete, unclear, and/or absent before testing began; 27 cases in which test resources were limited or not available; and 22 cases in which test reports did not always contain the most current, complete, or accurate data on the performance of major systems before production.

Has It Been Shown That the System Can Perform Effectively?

Examples of programs on which the effectiveness of the weapon in accomplishing its mission requirements was a significant issue we reported on include the following:

- In February 1992, we reported on the technological challenges that must be overcome under the Strategic Defense Initiative to proceed with the Global Protection Against Limited Strikes, a defense system that uses both ground- and space-based interceptors (GAO/IMTEC-92-18). Such a system pushes the cutting edge of technology. System developers will have to rely on some technologies that are not yet proven and learn how to integrate them into a reliable system. In a March 1992 report, we described how estimates of the effectiveness of Brilliant Pebbles, the proposed space-based weapon system, were based on relatively immature computer simulations that used many unproven assumptions about key operational and performance characteristics (GAO/NSIAD-92-91). Considering the uncertainties involved in a system of this complexity, we reported there was a significant risk that the level of protection promised would not be achieved.
- In August 1990, we reported on the results of our joint review with the German Federal Court Audit of the Rolling Airframe Missile program (GAO/NSIAD-90-208). The United States and Germany had agreed to jointly develop and produce the missile to provide close-in defense against antiship cruise missiles. Our analysis showed that the Rolling Airframe Missile's capabilities would be stressed or surpassed by most of the antiship missiles currently deployed or planned. The number and the capability of antiship missiles in various regions of the world had increased significantly since development of the missile had begun. These missiles had advanced performance characteristics for which the countering technology had yet to be developed. DOD and the German Ministry of Defense did not concur with the majority of our findings and recommendations. Congress, however, terminated the program, citing the concerns expressed in our report.

- In April 1990, we reported that problems with embedded computer resources, particularly software, were occurring more and more frequently and causing many weapon system cost overruns, schedule delays, and performance shortfalls (GAO/IMTEC-90-34). A recent example is the Navy's F-14D aircraft. In April 1992, we reported that the F-14D software contained serious defects that prevented the aircraft from meeting its operational requirements (GAO/IMTEC-92-21). Defects in the aircraft's embedded software have caused, for example, cockpit displays to go blank and erroneous data to be supplied to the mission computer. In addition, some originally planned software needed to support additional avionics and weapons capability was deferred due to development problems. At the time of our report, the Navy had already procured 43 F-14Ds, all of which will be delivered to the Navy without software required to meet mission objectives. Another example is the C-17 aircraft. In a May 1992 report, we discussed how the Air Force had assumed that software was a low-risk effort and had done little to manage its development or to oversee the contractor's performance (GAO/IMTEC-92-48). Problems occurred, and software development has fallen behind schedule. Software testing shortcuts were being taken to limit the impact on the schedule. Such shortcuts, however, raise the risks that software problems will go undetected until the aircraft's flight test phase.
- In October 1987, we reported on operational testing of the Army's Aquila remotely piloted vehicle (GAO/NSIAD-88-19). The test results showed that the Aquila would not perform its mission effectively. In 105 test flights, the system successfully performed all of the mission requirements only 7 times. It experienced major difficulties in consistently achieving a successful launch, in detecting targets, and in reaching acceptable reliability and maintainability levels. Major concerns also surfaced with the survivability of the aircraft and with its being able to be used proficiently by intended operators. The Congress did not fund the Aquila in fiscal year 1988, and the Army never pursued it into production.
- Live-fire testing in 1985 of the Army's Bradley Fighting Vehicle showed that the vehicle was highly vulnerable to all antiarmor weapons (GAO/NSIAD-87-40). The test results and Army vulnerability models further showed that ammunition stored inside the vehicle, when hit, was likely to be the major source of crew casualties and vehicle losses. Enhancements were made to the vehicle, but these only protected against the less effective enemy antiarmor weapons. For the Bradley to achieve an acceptable level of survivability, the Army planned to rely on the vehicle's mobility and firepower and on tactics to avoid overmatching enemy weapon systems, whenever possible. If survivability testing had been

performed earlier in the acquisition process, design changes might have been possible, thereby improving crew and vehicle survivability.

- In April 1979, we reported that recent battle experience and various Navy studies had shown that many, if not most, of the surface ships that would be in the U.S. fleet during 1975-90 had not been adequately designed to absorb and control damage from so-called "cheap kills" (PSAD-79-43). Weapon system performance and cost were being emphasized in ship design at the expense of survivability. For example, vital electronic equipment was being located in highly exposed areas. This allowed for better performance but made the equipment easily susceptible to damage from such things as small metal fragments from near misses of missiles or rockets. Measures to enhance ship survivability were estimated to cost several billion dollars. A limited number of improvements were implemented.
- The Navy's 8-inch Major Caliber Lightweight Gun for surface combatant ships was confronted with significant performance problems. In our August 1978 classified report on the gun, we noted that internal DOD studies had raised questions about the advisability of procuring it. The gun was to be deployed on Spruance class destroyers, which probably would not be available for amphibious assault operations or shore bombardment—two of the gun's primary missions—because the Spruance class destroyers would likely be committed to higher priority roles. Also, the range of hostile missiles was much greater than the gun's range, which could force the destroyers to remain at distances beyond the effective range of the gun. Despite these and other concerns, the Secretary of Defense approved the gun for limited production. The Congress, however, refused to support acquisition of the gun, and the program was terminated.

Is the System Suitable for Production and Fielding?

Specific examples of programs for which the ability of the contractor to produce it or the ability of the services to support the system was an issue include the following:

- In May 1992, we reported on concerns with the Air Force's Advanced Cruise Missile, including problems with quality that have plagued the program for several years and contributed to lengthy delivery delays (GAO/NSIAD-92-154). Although production quality was improving, the Strategic Air Command was continuing to identify manufacturing defects in missiles during receipt inspections. While some of these were minor, 3 of 26 missiles inspected by the Command between November 1991 and March 1992 had a critical subsystem failure. The program's baseline

schedule called for delivery of all of these high priority missiles by the end of fiscal year 1990. As of March 1992, only 40 had been delivered.

- In a December 1990 report on the Army's Air Defense Antitank System, we identified significant reliability problems that affected the system's operational availability (GAO/NSIAD-91-51). In our analysis of the system's 1990 operational tests, we found that the system had achieved an operational availability of less than 39 percent against a fielding requirement of 71 percent, that the fire unit had achieved an average time between operational mission failures of 9 hours against a fielding requirement of 60 hours, and that the weapon subsystem had demonstrated 8 hours mean time between operational mission failures against a fielding requirement of 92 hours. Additionally, there were important maintenance and logistics issues that had not yet been resolved.
- In April 1990, we testified that the Apache attack helicopter was experiencing availability rates that fell well short of the system's goals and that the rates were decreasing as units aged and accumulated flight hours (GAO/T-NSIAD-90-33). Below the surface of the low availability rates, we found serious logistical support problems such as undersized maintenance organizations, weaknesses in repair capabilities, and frequent component failures. While the Army had initiated numerous corrective actions to improve aircraft reliability and maintenance capabilities, many of these problems had been discovered by the Army in testing before the 1982 production decision, but production had continued without resolving the problems.
- In reports issued in May 1984, July 1987, and March 1989 on the Peacekeeper Intercontinental Ballistic Missile program, we reported on the inability of the contractor to produce inertial measurement units at a rate necessary to support missile deployment schedules (GAO/NSIAD-84-112, GAO/NSIAD-87-194BR, and GAO/NSIAD-89-105). Not only were the units being delivered late, but some delivered units were failing more often than expected, and repair times were longer than anticipated. The effect was to reduce the number of Peacekeeper missiles on alert. Improvements were implemented, thereby reducing the inertial measurement unit's failure rate and repair time.
- Production problems have contributed significantly to cost growth and schedule delays on the B-2 strategic bomber program. To a large extent, the cost increases and delays attest to the problems caused by numerous engineering changes, new manufacturing technologies, and difficulties the contractors are encountering in manufacturing low-observable aircraft that meet precise tolerances of stealth requirements. In a classified 1988 report, we discussed how extensive design changes to the aircraft in the early 1980s, coupled with concurrent development and manufacturing, had

caused labor inefficiencies and manufacturing defects. In addition, our report discussed difficulties in the manufacturing process and the potential for long-term producibility problems. For example, the aircraft's leading edges were handmade and required a complex bonding and sealing process. In July 1991, we reported that the B-2 contractors were still experiencing significant production difficulties (GAO/NSIAD-91-211).

- We have reported several times on the reliability of electronic warfare systems and the test equipment used to verify that the systems are functioning properly.² Our reviews across service lines have disclosed that the test equipment is often faulty and unreliable. In some instances, we found that electronic warfare systems considered to be combat ready actually had undetected faults because of unreliable built-in test equipment. In other instances, we found that test equipment deployed with the electronic warfare systems did not have all the components or software necessary for their use in diagnostics.
- In a 1983 classified report on the Army's Patriot air defense system, we reported that the diagnostic software used with the system's built-in test equipment had successfully identified faulty components only 50 to 60 percent of the time. To address these problems, the Army upgraded the software, added another level of maintenance, and increased maintenance training. Initial investment costs for these changes was about \$94 million.

²Electronic Warfare: Faulty Test Equipment Impairs Readiness of Army Helicopters (GAO/NSIAD-92-128, Apr. 17, 1992); Electronic Warfare: No Air Force Follow-up on Test Equipment Inadequacies (GAO/NSIAD-91-207, July 17, 1991); Electronic Warfare: Faulty Test Equipment Impacts Navy Readiness (GAO/NSIAD-91-205, July 8, 1991); Electronic Warfare: Need to Strengthen Controls Over Air Force Jammer Programs (GAO/NSIAD-90-168, July 11, 1990); and Electronic Warfare: Reliable Equipment Needed to Test Air Force Electronic Warfare Systems (GAO/NSIAD-89-137, Aug. 11, 1989).

Major Contributors to This Report

**National Security and
International Affairs
Division, Washington,
D.C.**

Frank C. Conahan, Assistant Comptroller General
Neal Curtin, Director of Planning and Reporting
Paul Francis, Project Director
Marvin Casterline, Project Manager
David Keefer, Evaluator

Ordering Information

The first copy of each GAO report and testimony is free. Additional copies are \$2 each. Orders should be sent to the following address, accompanied by a check or money order made out to the Superintendent of Documents, when necessary. Orders for 100 or more copies to be mailed to a single address are discounted 25 percent.

**U.S. General Accounting Office
P.O. Box 6015
Gaithersburg, MD 20877**

Orders may also be placed by calling (202)275-6241.

**United States
General Accounting Office
Washington, D.C. 20548**

**Official Business
Penalty for Private Use \$300**

**First-Class Mail
Postage & Fees Paid
GAO
Permit No. G100**
