

GAO

Report to the Chairman, Subcommittee
on Water, Power, and Offshore Energy
Resources, Committee on Interior and
Insular Affairs, House of
Representatives

July 1991

TRANS-ALASKA PIPELINE

Regulators Have Not Ensured That Government Requirements Are Being Met



144527

RESTRICTED—Not to be released outside the
General Accounting Office unless specifically
approved by the Office of Congressional
Relations.

RELEASED

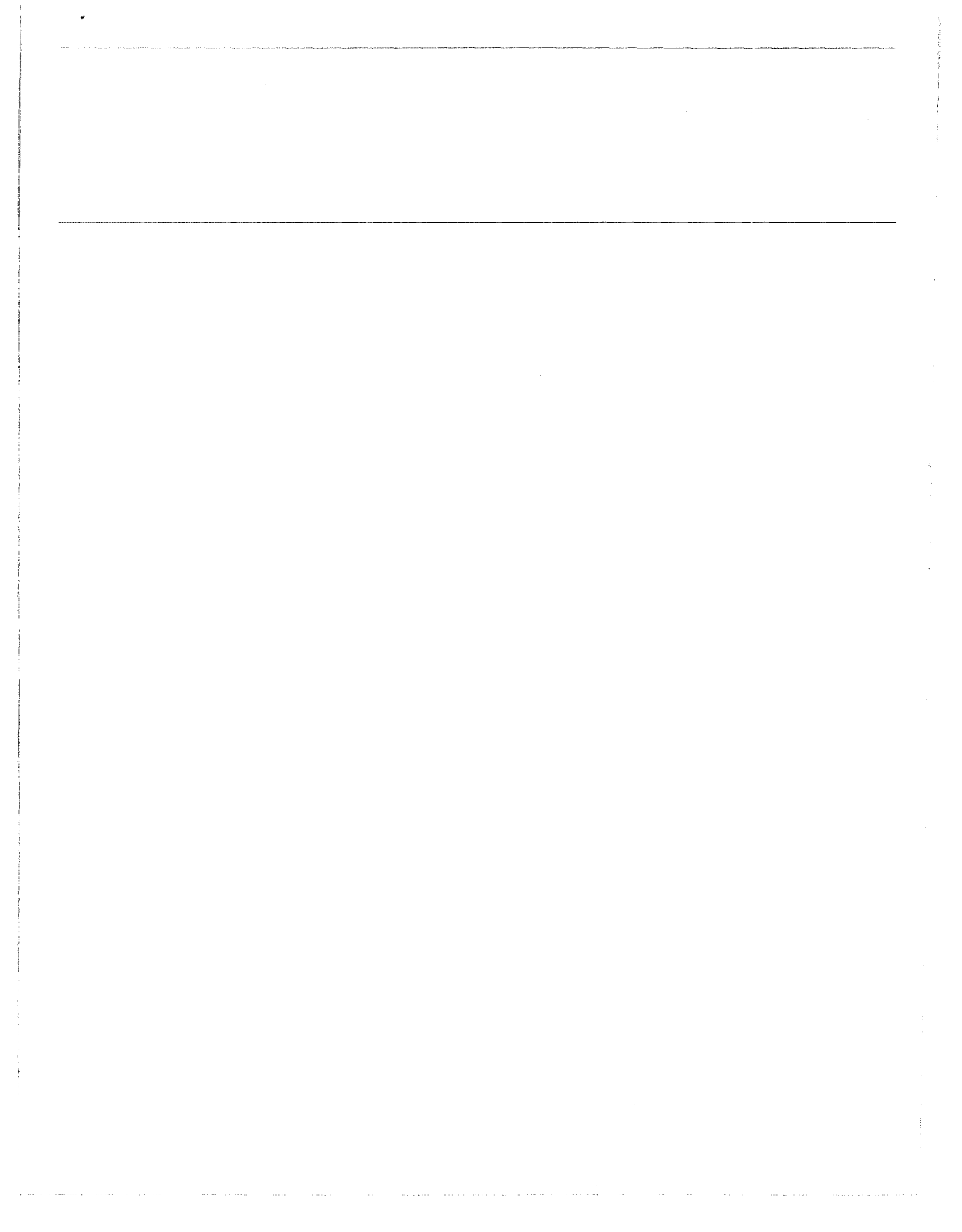



United States
General Accounting Office
Washington, D.C. 20548

Resources, Community, and
Economic Development Division

B-243032

July 19, 1991

The Honorable George Miller
Chairman, Subcommittee on Water,
Power, and Offshore Energy Resources
Committee on Interior and Insular
Affairs
House of Representatives

Dear Mr. Chairman:

This report responds to your request that we determine whether regulatory oversight has been adequate to ensure the Trans-Alaska Pipeline System's (TAPS) (1) operational safety, (2) oil spill response capabilities, and (3) ability to protect the environment. In addition, we are providing you with an update on the progress the Environmental Protection Agency (EPA) and the state of Alaska have made in issuing air and water quality permits for Valdez terminal operations.

As agreed, unless you publicly announce its contents earlier, we plan no further distribution of this report until 30 days from the date of this letter. At that time, we will send copies to the Secretaries of the Interior and Transportation; the Administrator, EPA; the Director, Bureau of Land Management, Department of the Interior; the Associate Administrator, Research and Special Programs Administration, Department of Transportation; the Commissioners of Alaska's Department of Environmental Conservation and Department of Natural Resources; the President, Alyeska Pipeline Service Company; and the Director, Office of Management and Budget. We will make copies available to others on request.

This review was performed under the direction of James Duffus III, Director, Natural Resources Management Issues, who can be reached at (202) 275-7756. Other major contributors are listed in appendix X.

Sincerely yours,

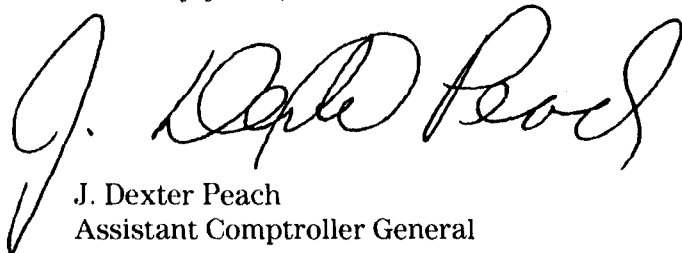

J. Dexter Peach
Assistant Comptroller General

Executive Summary

Purpose

The Trans-Alaska Pipeline System (TAPS) transports nearly 25 percent of the nation's domestically produced crude oil. Since operations began in 1977, TAPS has delivered over 8 billion barrels of oil to Port Valdez for shipment. The grounding of the Exxon Valdez in 1989 and the recent discovery of corrosion along the pipeline have focused more attention on the risks associated with transporting oil. A major break in the pipeline could spill tens of thousands of barrels of oil on Alaska's fragile environment, and an extended shutdown for repairs from such an accident could affect the nation's domestic oil supply.

The 800-mile-long pipeline system crosses arctic permafrost (permanently frozen soil), 3 mountain ranges, about 800 rivers and streams, and 3 known seismic fault zones. To minimize the pipeline's impact on the natural environment and lessen the potential for oil spills, federal and state regulators imposed special engineering design and operating requirements. Concerned as to whether these requirements are being met, the Chairman, Subcommittee on Water, Power, and Offshore Energy Resources, House Committee on Interior and Insular Affairs, asked GAO to determine, among other things, whether regulatory oversight has been adequate to ensure TAPS' operational safety, oil spill response capabilities, and ability to protect the environment.

Background

The 48-inch-diameter pipeline system is complex in design and operation, in part because of the rugged environment in which it was built and operates. Alyeska Pipeline Service Company directed the design and construction of TAPS and is responsible for operating the pipeline safely and protecting the environment from potential damage.

The principal federal requirements governing TAPS are contained in the right-of-way agreement under the Trans-Alaska Pipeline Authorization Act. This agreement governs the construction, operation, and maintenance of the pipeline on federal lands and is administered by the Department of the Interior's Bureau of Land Management (BLM). It also requires that Alyeska reimburse BLM for all reasonable oversight costs associated with monitoring TAPS. A similar agreement governs TAPS' operations on state and private lands and is administered by Alaska's Department of Natural Resources. Other laws and/or requirements governing TAPS include the Hazardous Liquid Pipeline Safety Act, administered by the Department of Transportation's Office of Pipeline Safety, and federal and state clean air and water legislation, administered by the Environmental Protection Agency (EPA) and Alaska's Department of Environmental Conservation.

Results in Brief

While Alyeska has the basic responsibility for complying with various regulatory requirements, government regulators are also responsible for ensuring that Alyeska's actions result in the pipeline being operated safely and in an environmentally sound manner. However, the five principal federal and state regulatory agencies have not had the systematic, disciplined, and coordinated approach needed to regulate TAPS. Instead, these agencies relied on Alyeska to police itself. For example, the regulators did not systematically or independently assess Alyeska's corrosion prevention and detection or leak detection systems, nor did they require that Alyeska demonstrate that it can respond adequately to a large-scale oil spill.

It was not until after the Exxon Valdez incident and the discovery of corrosion that the regulators began to reevaluate their roles and focus on issues such as whether Alyeska's operating and maintenance procedures meet the pipeline's special engineering design and operating requirements, or whether Alyeska can adequately and promptly respond to a large-scale oil spill. In January 1990, the regulators established a joint office to provide for more effective TAPS oversight. GAO believes that central leadership and a secured funding source may help ensure that this office provides adequate oversight.

Principal Findings

Compliance With Design and Operating Requirements Not Fully Assessed

Until the Exxon Valdez incident and the identification of corrosion, the regulators had neither systematically assessed nor monitored Alyeska's implementation of TAPS' corrosion prevention and detection systems or determined whether changes were needed. To lessen the potential for oil spills, the right-of-way agreements require a corrosion resistant design and measures to prevent and detect corrosion, detect leaks, and minimize the effects of geological hazards. However, none of the regulators independently examined the adequacy of these systems until after Alyeska reported corrosion along the pipeline, at the pump stations, and in crude oil storage tanks at the Valdez terminal in 1989. Instead, the regulators essentially relied on Alyeska's assurances that it was meeting these requirements.

Under the auspices of the joint office formed in 1990, federal and state regulators are just now beginning to monitor significant aspects of the Valdez terminal operations—including the structural integrity of the 18

oil storage tanks. The joint office is also investigating the cause, extent, and repair of corrosion along the pipeline, at the pump stations, and in the crude oil storage tanks at the Valdez terminal. In addition, the regulators have scheduled the first test of Alyeska's leak detection system for July 1991. Although Alyeska has a computerized leak detection system, none of the spills that occurred along the pipeline since operations began in 1977 were initially detected by the system.

Although TAPS crosses some of the most hazardous geologic terrain of any pipeline in the world—including areas with unstable soil or rock slopes and/or earthquake faults, neither BLM nor the Alaska Department of Natural Resources has systematically evaluated the effectiveness of the engineering design and Alyeska's operations and maintenance procedures under harsh arctic conditions.

Oil Spill Response Capability Not Fully Demonstrated

In the event of an actual spill, the regulators are expected to be on the scene, and if they are not satisfied with Alyeska's actions to contain and clean up a spill, to direct the effort. However, federal and state regulators did not regularly participate in the drills or review the drill critiques prepared by Alyeska to ensure that identified problems were corrected. In addition, federal and state regulators have not required Alyeska to conduct a companywide, full-scale drill that, at one time, tests the leadership, coordination, communication, and equipment and personnel mobilization required to locate, contain, and clean up a large-scale oil spill.

Regulators' Actions Since the Exxon Valdez Oil Spill

The joint oversight office has brought together in one location most of the regulators and has significantly increased the resources directed at TAPS oversight. The efforts of this office represent steps towards achieving a systematic, disciplined, and coordinated approach for overseeing TAPS. This is important, given that Alaska's energy sources are likely to be a critical component of the nation's long-term energy strategy. For example, TAPS is the most likely means of transport if the Arctic National Wildlife Refuge is opened for oil development. In addition, the pipeline corridor will be used in the construction of a natural gas pipeline from the North Slope to Valdez. GAO believes that central leadership and a secured funding source may help ensure that this office provides adequate oversight. While increased TAPS oversight will require more up-front costs, comparing these costs with the costs associated

with mitigating the environmental impacts of a major oil spill or the disruption in the delivery of 25 percent of the nation's domestic oil production may show the value of spending additional funds now to help to ensure the pipeline's safe operation.

Recommendations

GAO makes recommendations to the Secretaries of the Interior and Transportation and the Administrator of EPA to better ensure a systematic, disciplined, and coordinated oversight approach. Among other things, this would include a central leader and a secured funding source.

Matter for Congressional Consideration

To help ensure that sufficient funds are available to support improved inspection and oversight, GAO believes that the Congress may wish to consider requiring Alyeska to fully reimburse the joint office for all reasonable oversight costs as Alyeska is now required to do for BLM.

Agency Comments

The five regulatory agencies and Alyeska commented that GAO's report should more clearly distinguish between their actions before the Exxon Valdez incident and after the establishment of the joint office. The report has been clarified as necessary. Although Interior disagreed with some of GAO's conclusions regarding the adequacy of regulatory oversight, it, as well as the other regulators, indicated that the joint office is already implementing many of GAO's recommendations relating to operational safety and oil spill contingency response. If properly implemented, these actions should address the intent of GAO's recommendations. GAO believes that the establishment of this office is an important first step, but continues to be concerned that there is no central leader or secured funding source for the joint office. Alyeska believes that the report implies that the pipeline is not well run and that GAO has underestimated the involvement of the federal and state regulators. GAO evaluated the adequacy of the regulatory oversight of TAPS, not the actions of Alyeska. GAO found this oversight to be limited before the Exxon Valdez incident, a conclusion that is generally shared by the regulators themselves.

Contents

Executive Summary		2
<hr/>		
Chapter 1		10
Introduction	TAPS' Description and Operation	10
	Trans-Alaska Pipeline System Legislation and Requirements	11
	Regulatory Oversight Authorities and Organizations	15
	Objectives, Scope, and Methodology	17
<hr/>		
Chapter 2		21
Regulators Did Not Ensure That Special Requirements Intended to Lessen the Potential for Oil Spills Have Been Met	Regulators' Monitoring of Alyeska's Corrosion Prevention and Detection Systems Was Inadequate	21
	Regulators Have Not Required That the Computerized Leak Detection System Be Tested	26
	Regulators Did Little to Monitor Alyeska's Efforts to Address Geologic Hazards	29
	Terminal Storage Tank Integrity Was Not Reviewed	34
	Conclusions	37
	Recommendations	37
	Agency Comments	38
<hr/>		
Chapter 3		39
Oil Spill Response Capability Not Fully Demonstrated	Review of Oil Spill Contingency Plan Was Limited	39
	Alyeska's Ability to Respond to a Large-Scale Spill Remains Unknown	42
	Actions Taken Since the Exxon Valdez Oil Spill	45
	Full-Scale Testing Needed as Part of Approval Process	46
	Conclusions	46
	Recommendations	47
	Agency Comments	47
<hr/>		
Chapter 4		49
Environmental Impacts of TAPS Not Fully Examined	Long-Term Monitoring Program Is Needed	49
	More Oil Spill Research Is Needed	50
	Conclusions	53
	Recommendations	54
	Agency Comments	54

<hr/>		
Chapter 5		55
TAPS' Oversight	Elements of a Systematic, Disciplined, and Coordinated Approach	55
Needs Systematic,	TAPS' Oversight Approach Lacked Structure	56
Disciplined, and	Staffing Levels Limited Oversight Activities	59
Coordinated Approach	Oversight Coordination Was Limited	60
	New Federal/State Joint Office Established to Aid Oversight	61
	Conclusions	63
	Recommendations	64
	Matter for Congressional Consideration	64
	Agency Comments	64
<hr/>		
Appendixes		
	Appendix I: Update on Air Quality Control Permit	66
	Appendix II: Update on Ballast Water Treatment Permit	70
	Appendix III: Comments From the Department of the Interior	72
	Appendix IV: Comments From the Department of Transportation	78
	Appendix V: Comments From the Environmental Protection Agency	89
	Appendix VI: Comments From the State of Alaska	92
	Appendix VII: GAO Response to Agencies' Comments	95
	Appendix VIII: Comments From Alyeska Pipeline Service Company	99
	Appendix IX: GAO Response to Alyeska's Comments	107
	Appendix X: Major Contributors to This Report	110
<hr/>		
Figures		
	Figure 1.1: Federal and State Administrative Authority of TAPS' Right-of-Way	13
	Figure 2.1: Cathodic Protection System	22
	Figure 2.2: Vertical Support Member	31
	Figure 2.3: View of the Valdez Terminal	35

Abbreviations

BLM	Bureau of Land Management
EPA	Environmental Protection Agency
GAO	General Accounting Office
NPDES	National Pollution Discharge Elimination System
OCS	Outer Continental Shelf
PSD	Prevention of Significant Deterioration
SPCC	Spill, Prevention, Control, and Countermeasures
TAPA	Trans-Alaska Pipeline Authorization Act
TAPS	Trans-Alaska Pipeline System

Introduction

The Trans-Alaska Pipeline System (TAPS) is the primary transportation link for delivering nearly 25 percent of the nation's domestically produced oil. Built between 1974 and 1977 on federal, state, and private lands within a narrow corridor, TAPS provides access to Alaska's North Slope oil reserves. The 800-mile-long pipeline system and its terminal facility at Port Valdez were designed and constructed to endure arctic conditions and meet exacting government requirements for minimizing impacts on the natural environment. The pipeline has transported over 8 billion barrels¹ of oil to Port Valdez for shipment to domestic markets since 1977. However, the grounding of the Exxon Valdez in March of 1989, the resulting massive oil spill and cleanup efforts, and the recent discovery of corrosion along the pipeline have focused more attention and concern on the risks associated with transporting oil.

The long-term safe operation and integrity of TAPS are crucial to ensuring the continuity of the domestic oil supply. Alaska's energy sources are likely to be a critical component of the nation's long-term energy strategy. Not only does TAPS currently serve as the means for transporting billions of barrels of oil pumped from Alaska's North Slope, but it is a likely means of transport if the Arctic National Wildlife Refuge—an area considered to be of high oil potential—is opened to development and oil is found. In addition, the pipeline corridor will be used for transporting natural gas from the North Slope to Valdez.

TAPS' Description and Operation

TAPS is a complex pipeline system in design and operation, owing in part to the rugged environment in which it was built. The pipeline carries about 2 million barrels of hot oil per day across Alaska. A series of 10 pump stations help move the oil under pressure from the North Slope, north of the Arctic Circle, to Port Valdez on Prince William Sound, which takes about 4-1/2 days. The 48-inch-diameter pipeline crosses 3 mountain ranges, about 800 rivers and streams, 3 known seismic fault zones—one of which is considered active—and hundreds of miles of permafrost (permanently frozen soil). In the event of an earthquake

¹One barrel equals 42 gallons.

greater than 6.5 on the Richter scale, the pipeline is designed to automatically shut down. More than half of the line is elevated, while the remainder is buried.²

The largest single facility in the TAPS system is the Valdez terminal. The terminal includes the operations control center, where the pipeline is monitored and controlled by remotely operated valves and pump station equipment. The operations control center receives a constant flow of information about conditions along the pipeline, including specific information on flow rates, pressures, leak detection, and seismic events. The terminal also includes 18 storage tanks with a total capacity of about 9 million barrels, and 4 berths with the connecting pipe, valves, and controls necessary to simultaneously transfer oil to oceangoing tankers. The terminal was designed and constructed to withstand special geologic and seismic conditions, including the ability to withstand earthquakes and tidal waves.

Alyeska Pipeline Service Company (Alyeska)³ directed the design and construction of TAPS, subject to government regulator approval, and is responsible for conducting pipeline operations within the parameters established by federal and state requirements. Among other things, Alyeska is required to maintain complete, updated records and reports of operation and maintenance activities, which are subject to review by federal and state regulatory authorities.

Trans-Alaska Pipeline System Legislation and Requirements

Several federal and state laws and requirements govern the operation and maintenance of TAPS. While in many respects TAPS is regulated as any other major pipeline, in its unique role as the supplier of 25 percent of the nation's crude oil and because of the unique conditions under which it operates, TAPS is subject to greater regulatory oversight. The Congress imposed special conditions and provided special concessions for the design, construction, operation, and maintenance of the pipeline. The principal law governing the operation of TAPS is the Trans-Alaska

²The temperature of oil rising through the ground on the North Slope ranges up to 180 degrees Fahrenheit. The maximum temperature of oil entering the pipeline at pump station 1 is 145 degrees Fahrenheit. The oil cools to about 115° F by the time it reaches the Valdez terminal. Elevating the pipeline in permafrost areas where the soil can become unstable if thawed, rather than burying it, prevents the hot oil pipeline from thawing the permafrost. Such thawing could reduce the pipeline's support; damage the pipeline, thus causing a leak; and result in ecological damage.

³The Alyeska Pipeline Service Company was created by an agreement between seven companies. The current owners are Amerada Hess Pipeline Corp.; ARCO Transportation Alaska, Inc.; BP Pipelines (Alaska) Inc.; Exxon Pipeline Co.; Mobil Alaska Pipeline Co.; Phillips Alaska Pipeline Corp.; and Unocal Pipeline Co.

Pipeline Authorization Act (TAPA) (Title II of P.L. 93-153), enacted on November 16, 1973. It declared that development and delivery of oil from Alaska's North Slope to domestic markets were in the national interest and authorized the construction of TAPS. The act directed the Secretary of the Interior and other federal officers and agencies to issue, administer, and enforce a right-of-way agreement and to issue regulations or stipulations that govern the construction, operation, and maintenance of TAPS.⁴ In January 1974, the U.S. government and seven companies signed an Agreement and Grant of Right-of-Way (right-of-way agreement) for the construction of the pipeline. The right-of-way agreement includes requirements for designing, constructing, and operating the pipeline to protect the environment and meet sound engineering practices. The requirements apply to TAPS operations on federal lands. Similar requirements have been developed by Alaska in a state right-of-way agreement⁵ for TAPS operations on state and private lands. As part of these agreements, Alyeska is required to develop, subject to approval, a quality assurance program and an operations and maintenance plan that specifies how Alyeska plans to meet the requirements outlined in the right-of-way agreements. TAPS must also meet other requirements specified in federal and state laws directed at pipeline safety and air and water quality.

TAPS Right-of-Way Administration

Under the authority of TAPA, and the federal and state right-of-way agreements, the federal government is responsible for enforcing requirements on federal lands, and the state of Alaska is responsible for enforcing requirements on state and private lands. The federal government presently has administrative responsibility for 579 miles of the pipeline's right-of-way, while the state administers the remaining 221 miles, including the Valdez terminal. A map showing federal and state right-of-way administrative authority is presented in figure 1.1.

⁴Right-of-way agreements issued by the Secretary are subject to the provisions of section 28 of the Mineral Leasing Act, as amended by Title I of P.L. 93-153. The act authorizes the Secretary to (1) impose requirements for pipeline safety and environmental protection applicable to pipelines through federal lands and (2) promulgate regulations or stipulations for the agreements.

⁵This agreement is called a "right-of-way lease"; however, for clarity's sake, we will refer to both federal and state right-of-way documents as "agreements."

Figure 1.1: Federal and State Administrative Authority of TAPS' Right-of-Way

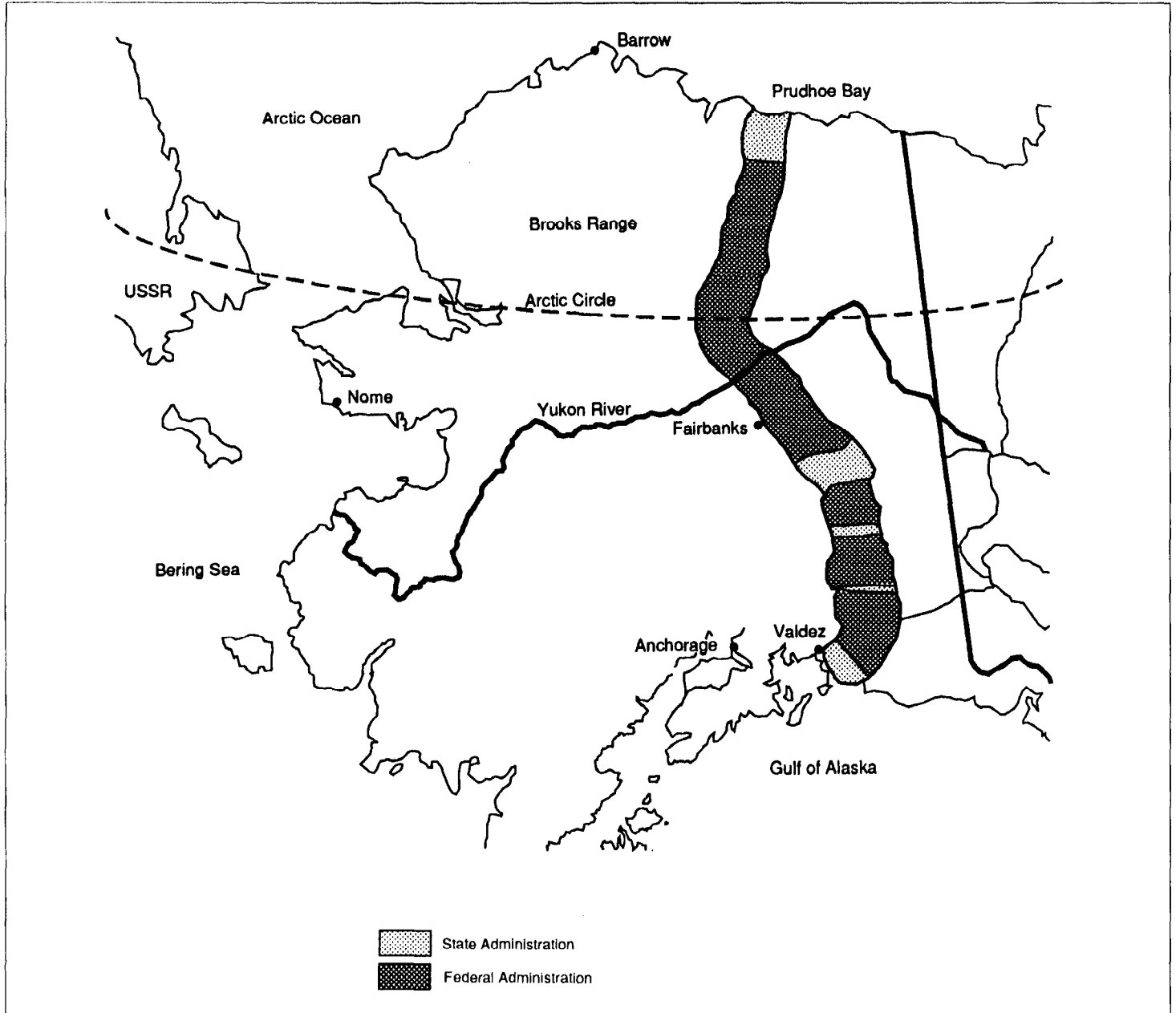

Source: BLM and GAO.

Legislation Promoting Operational Safety

In addition to TAPA, which is directed solely at TAPS, the Hazardous Liquid Pipeline Safety Act of 1979, administered by the Department of Transportation, governs the integrity and safety of all interstate and intrastate petroleum pipeline transportation systems in the United States—including TAPS. These pipeline systems must comply with federal standards for design, construction, testing, and operation and maintenance. These standards are contained in Transportation's Pipeline Safety Regulations. Among other things, the regulations require mechanisms for minimizing and detecting corrosion, reporting oil leaks, and limiting pipeline movement.

Environmental Legislation and Requirements

The federal and state right-of-way agreements require that TAPS construction and operation minimize environmental degradation and ensure the free passage of fish and big game animals throughout the life of the TAPS project. They also hold the pipeline operator responsible for meeting national and state air quality measures, preventing erosion, and minimizing disturbances to vegetation. In addition, the requirements call for the development and demonstration of an oil spill emergency response plan.

TAPS operations also are subject to several federal environmental laws applying to potential pollution sources. Under the Clean Air Act, Alyeska is required to limit emissions of pollutants at its facilities. Alyeska was issued its initial air quality permit in 1974, before the current air quality regulations became effective. Alyeska was issued a new permit in 1990.

The Clean Water Act calls for establishing regulations to guide against degradation from waste discharges. To control pollutant discharges, Alyeska is required to obtain a National Pollutant Discharge Elimination System (NPDES) permit for the treatment of ballast water⁶ at the Valdez terminal. To control oil spills, the act's implementing regulations established the Spill, Prevention, Control, and Countermeasures Program and the National Oil and Hazardous Substances Pollution Contingency Plan. The Spill, Prevention, Control, and Countermeasures Program requires, among other things, that pipeline operators construct special containment areas around storage tanks to prevent a potential spill from escaping into a waterway. Regulations for the National Contingency

⁶Ballast water is sea water that is carried in oil tankers to provide stability when oil is not being transported; the water can be contaminated with oil. The ballast water is off loaded and treated before being discharged into the Port of Valdez.

Plan provides guidance for developing oil spill emergency response plans.

Regulatory Oversight Authorities and Organizations

The importance of continued monitoring and evaluation of TAPS operations was emphasized in the TAPS environmental impact statement published in 1970:

On this unprecedented project, maintenance may well be greater than on conventional pipelines, and inspection and study [would] be necessary to build up operating experience and check on design assumptions.

The laws, requirements, and regulations intended to ensure TAPS' operational safety, oil spill response, and environmental protection call for monitoring and enforcement by several federal and state agencies. These agencies include the Department of the Interior, which is charged with enforcing the federal right-of-way agreement on federal lands, and Alaska's Department of Natural Resources, which enforces the state's right-of-way agreement on state-owned and private lands. Transportation's Office of Pipeline Safety is responsible for overseeing the operational safety of the entire pipeline under the Hazardous Liquid Pipeline Safety Act. In addition, the Environmental Protection Agency (EPA) and the Alaska Department of Environmental Conservation are responsible for enforcing environmental regulations along the pipeline and at the terminal. Together, these five agencies are responsible for monitoring and assessing TAPS' operations and maintenance procedures to ensure that the pipeline is operated safely, that oil spill response is adequate, and that the environment is adequately protected.

Interior

Interior is responsible for monitoring TAPS' operations on federal lands to ensure compliance with the right-of-way agreement and the Mineral Leasing Act. Additionally, Interior has full and free access to state and private lands, including the Valdez terminal, for enforcing federal right-of-way requirements. Interior's responsibilities and authorities are the most comprehensive and broadest in scope of any of TAPS' regulators—covering operational safety, oil spill emergency response, and environmental protection issues. Further, construction or repairs to the pipeline system require prior approval from an Interior-appointed TAPS Authorized Officer. Currently, the Authorized Officer is within Interior's Bureau of Land Management (BLM) Alaska State Office. The Authorized Officer may require modifications to TAPS' operations if improvements

are needed to ensure pipeline safety and may order the temporary suspension of TAPS operations if they are determined to be unsafe. Under the Mineral Leasing Act, as amended, activities performed by the Authorized Officer that are necessary to fulfill monitoring responsibilities are fully reimbursable by Alyeska.

During pipeline construction, the Authorized Officer was located in Interior's Alaska Pipeline Office. The focus of that office was to ensure that TAPS was constructed with maximum engineering and environmental safeguards. To oversee this \$8 billion construction project, the Pipeline Office employed a multi-disciplined staff of about 150 engineering and science professionals. The Pipeline Officer worked with other professionals from other federal agencies, including Transportation, the U.S. Geological Survey, the National Marine Fisheries Service, and the U.S. Fish and Wildlife Service. Additionally, the Pipeline Office retained consultants to assist in design review and construction surveillance. During the construction period, all of TAPS' designs and construction activities were reviewed and approved by engineers and on-site field inspectors. Shortly after TAPS' startup in 1977, the Pipeline Office's oversight efforts focused on environmental protection, integrity of the pipeline to prevent oil spills, and public safety. In 1979 the Authorized Officer function was transferred to BLM.

**Alaska Department of
Natural Resources**

The state's right-of-way agreement contains oversight authority similar to Interior's for pipeline operations on state and private lands. This authority includes requiring compliance with the agreement, requiring improvements when necessary, and suspending pipeline operations if they are not safe. The responsibility for ensuring compliance rests with the Pipeline Coordinator, Department of Natural Resources.

**Transportation's Office of
Pipeline Safety**

Transportation's Office of Pipeline Safety is responsible for enforcing the Hazardous Liquid Pipeline Safety Act for all interstate pipelines, as well as those pipelines within states that do not have state pipeline safety programs, such as Alaska. The Office of Pipeline Safety's primary responsibilities are to monitor pipeline operations for compliance with federal safety standards and to ensure that remedial actions taken in the event of pipeline spills and accidents are adequate.

EPA

EPA is responsible for ensuring the environmental compliance of TAPS' operations under several federal laws, including the Clean Air Act and

the Clean Water Act. EPA has delegated parts of the Clean Air Act's enforcement responsibilities to the state and is responsible for monitoring the state's actions to ensure that air quality standards are met.⁷ EPA is responsible for enforcing the Clean Water Act—although the state assists EPA in carrying out its responsibilities—including monitoring the day-to-day operations of TAPS. Under the act, EPA issues and enforces the NPDES permits and the requirements under the Spill Prevention, Control, and Countermeasures Program.

Alaska Department of Environmental Conservation

Alaska's Department of Environmental Conservation enforces all or portions of federal and state environmental laws, including activities covering air and water. In conjunction with the responsibilities delegated by EPA under the Clean Air Act, the Department issues air quality permits for TAPS pipeline and terminal operations and assists EPA in developing the NPDES permit for water treatment facilities at the Valdez terminal. The Department's other responsibilities related to TAPS include reviewing and approving the terminal and Prince William Sound oil spill contingency plans and monitoring oil spill clean-ups. Additionally, since the Exxon Valdez oil spill, the Department has been given the authority to review and approve the pipeline's contingency plan.

Objectives, Scope, and Methodology

The Chairman, Subcommittee on Water, Power, and Offshore Energy Resources, House Committee on Interior and Insular Affairs, asked us to determine whether regulatory oversight has been adequate to ensure TAPS' (1) operational safety, (2) oil spill response capabilities, and (3) ability to protect the environment. We addressed these issues for the entire pipeline system, from pump station No. 1 on Alaska's North Slope to the terminal located at Port Valdez.⁸ In addition, the Chairman asked us to provide an update on the progress EPA and the Alaska Department of Environmental Conservation have made on issuing air and water quality permits for Valdez terminal operations. (This information is contained in apps. I and II.)

⁷EPA delegates a program to a state if the state adopts regulations that are at least as stringent as EPA's. When a program is delegated, the state has primary responsibility for inspecting and enforcing requirements, such as those contained in an air quality permit. However, EPA maintains the authority to enforce all requirements under the Clean Air Act, should the state fail to take adequate action.

⁸This report does not evaluate the U.S. Coast Guard's regulatory oversight of pipelines because it is the subject of a separate GAO report entitled Pollution From Pipelines: DOT Lacks Prevention Program and Information for Timely Response (GAO/RCED-91-60, Jan. 1991).

We visually observed TAPS operations along the pipeline from pump station No. 1 on the North Slope to pump station No. 8 south of Fairbanks, and at the Valdez terminal. During these observation tours, we interviewed pipeline employees and Alyeska management officials. In addition, we interviewed Alyeska corporate officers and engineering representatives at Alyeska's corporate headquarters in Anchorage, Alaska, and gathered extensive information on TAPS' operation, maintenance, and monitoring. Alyeska's attorneys in Washington, D.C., arranged our pipeline visits, were present on inspections and at interviews, prepared or assisted in preparing written responses to our questions, and prereviewed Alyeska documentation requested during our interviews.

In reviewing the adequacy of regulatory oversight, which encompasses the issues of operational safety, oil spill response, and environmental protection, we focused our review on a 5-year period—from 1985 until 1989—the most recent 5-year period before the grounding of the Exxon Valdez. We have also provided information on regulatory activities as of April 1991, primarily involving the formation of a joint oversight office.

To determine if clear and enforceable requirements existed, we reviewed the requirements from applicable regulations or right-of-way agreements and interviewed agency officials to determine what actions they took to ensure that various requirements were complied with. We also identified whether the agencies had developed criteria to measure whether Alyeska was meeting these requirements.

To assess whether detailed guidance on monitoring, follow-up, and enforcement procedures existed, we determined if (1) checklists or other formal documentation requirements existed to guide monitoring activities, (2) reports were prepared to document inspections, and (3) procedures existed for follow-up and enforcement actions. Additionally, we determined the type of monitoring conducted by each agency, including the number of inspections and enforcement actions completed. To determine if there were adequate numbers of trained staff, we obtained staffing statistics and interviewed agency officials. To assess whether adequate coordination existed, we interviewed agency officials and determined whether any formal agreements existed between agencies.

In addition to interviewing various officials and reviewing records, to determine the regulators' effectiveness in assessing operational safety of the pipeline, we focused on four major areas as agreed to with the requester: leak detection, corrosion prevention and detection, geological

hazards, and storage tank integrity. As part of our review of corrosion, we reviewed available noncompliance reports issued during the pipeline's construction as well as summary reports (called "Start-up System Check Reports") that identified the number of noncompliance reports issued and the types of problems identified. The summary reports that we obtained from BLM covered the entire below ground sections of the pipeline. To determine the regulators' effectiveness in assessing the adequacy of oil spill readiness, we reviewed requirements contained in the National Contingency Plan.⁹ We also examined federal and state procedures for reviewing, approving, and testing TAPS oil spill plans. In addition, we reviewed Alyeska's records to determine the frequency and extent to which TAPS oil spill plans have been tested and examined critiques of the oil spill drills that had been conducted.

To assess the regulators' efforts to monitor environmental protection efforts, we retained an expert from the University of Alaska's Arctic Environmental Information and Data Center in Anchorage as a consultant on the environmental monitoring of TAPS. The consultant analyzed existing information completed between 1970 and 1989 that addressed (1) the various aspects of environmental monitoring of TAPS, (2) the management of inland oil spills, or (3) known environmental effects of TAPS operations.

We conducted our work at the headquarters of BLM, EPA, and Transportation's Office of Pipeline Safety in Washington, D.C. We also visited BLM's Branch of Pipeline Monitoring in Anchorage, Alaska; the Office of Pipeline Safety's Western Region in Denver, Colorado; and EPA's Region X in Seattle, Washington, and operations office in Anchorage, Alaska. We interviewed officials from the U.S. Coast Guard, the U.S. Army Corps of Engineers, and Interior's Fish and Wildlife Service. At the state level, we met with officials from Alaska's Department of Natural Resources in Anchorage and Juneau; the Department of Environmental Conservation in Anchorage, Juneau, Fairbanks, and Valdez; and the Department of Fish and Game in Juneau and Fairbanks.

In addition, to assist us in gathering information on geohazards, our staff geologist interviewed officials and technical staff of the U.S. Geological Survey (in Reston, Virginia; Anchorage, Alaska; and Menlo Park, California), Department of Energy, and University of California at

⁹The federal right-of-way agreement requires that Alyeska's Oil Spill Contingency Plan conform to National Contingency Plan requirements. These requirements establish minimum criteria for developing and implementing contingency plans, including a list of provisions necessary to ensure that full resource capability is known and can be committed during an oil spill.

Berkeley. He also conducted an extensive literature search and review of Alyeska and Interior's geologic, engineering, and inspection data and records to identify the potential impact of natural hazards on TAPS' operations.

We interviewed representatives of industry groups, including the American Petroleum Institute and the Association of Oil Pipelines in Washington, D.C.; and BP Alaska Exploration Co. and ARCO Alaska, Inc., two North Slope oil producers. We interviewed an official from the Natural Resources Defense Council in Washington, D.C., an environmental organization. Additionally, we interviewed mining and civil engineers from the U.S. Bureau of Mines, the Mine Health and Safety Administration, and the Federal Highway Administration.

To address the progress made on issuing new air and water quality permits at the Valdez terminal, we updated information contained in two issued GAO reports, Air Pollution: Status of Dispute Over Alaska Oil Pipeline Air Quality Controls (GAO/RCED-89-37, Dec. 9, 1988) and Water Pollution: Alyeska's Efforts to Comply With Reissued Ballast Water Treatment Permit (GAO/RCED-90-124, May 8, 1990). See appendixes I and II for summaries of our findings regarding these issues.

We conducted our review between June 1989 and April 1991 in accordance with generally accepted government auditing standards. Alyeska, Interior, Transportation, EPA, and the state of Alaska provided written comments on a draft of this report. These comments are presented and evaluated in appendixes III to IX.

Regulators Did Not Ensure That Special Requirements Intended to Lessen the Potential for Oil Spills Have Been Met

To lessen the potential for oil spills, the Congress imposed special engineering design and operating requirements on TAPS as conditions for granting the pipeline's right-of-way. These requirements include, among other things, a corrosion-resistant design and methods to prevent and detect corrosion, leak detection, protection from geological hazards, and storage tank integrity at the Valdez terminal.

Although Alyeska is responsible for meeting the various requirements, it is up to government regulators to determine whether Alyeska's actions are adequate. However, over the last several years, the regulators essentially accepted Alyeska's data and reports that it was meeting these requirements without independent analysis or testing. For example, Alyeska has experienced difficulties with various aspects of its corrosion prevention and detection systems. Although regulators were aware of these difficulties, they did not independently evaluate the corrosion prevention and detection systems nor direct that Alyeska take alternative measures until after corrosion was detected by Alyeska in 1989. Since that time, federal and state regulators have developed a plan to monitor corrosion and worked with Alyeska to review its leak detection system. Additionally, they have begun monitoring the storage tanks at the Valdez terminal.

Regulators' Monitoring of Alyeska's Corrosion Prevention and Detection Systems Was Inadequate

One of the many preconstruction concerns about the pipeline's safe operation was that a hot-oil pipeline in Alaska's frozen or near-frozen ground would cause the ground to thaw, allowing water to contact the pipeline and cause external corrosion. The federal and state right-of-way agreements and Transportation's regulations required Alyeska to develop a corrosion-resistant design and maintain a system to minimize and detect corrosion under these conditions. In 1989, 12 years after TAPS began operating, Alyeska discovered significant external corrosion along sections of buried pipeline and pipe in the pump stations. During this time, federal and state regulators did not closely monitor Alyeska's system for corrosion prevention and detection, relying instead on Alyeska's data and reports that corrosion was not occurring.

BLM, Transportation's Office of Pipeline Safety, and the Alaska Department of Natural Resources have been aware of deficiencies in the systems that were designed to prevent corrosion since the pipeline was constructed. They have also known that the technology of Alyeska's corrosion detection devices was evolving and, at the time, did not provide a clear picture if, or where, corrosion was occurring. Nevertheless,

the regulatory agencies did not require Alyeska to increase its monitoring for corrosion and have not independently assessed the corrosion detection data. This regulatory inattention has resulted in an intensive effort by the regulators, along with Alyeska, to determine the extent, severity, and cause of corrosion problems identified in 1989.

Pipeline Corrosion Prevention and Detection Systems

The TAPS right-of-way requirements, as well as Transportation's pipeline safety regulations, call for corrosion-resistant design and methods for the early detection of corrosion. In response to these requirements, Alyeska developed a three-part corrosion prevention and detection system for the pipeline. First, to keep water and corrosive activity away from the steel pipe, it was coated with epoxy and covered with protective tape. Second, a cathodic protection system¹ was installed to protect the steel pipe against corrosion. (See fig. 2.1.)

Figure 2.1: Cathodic Protection System

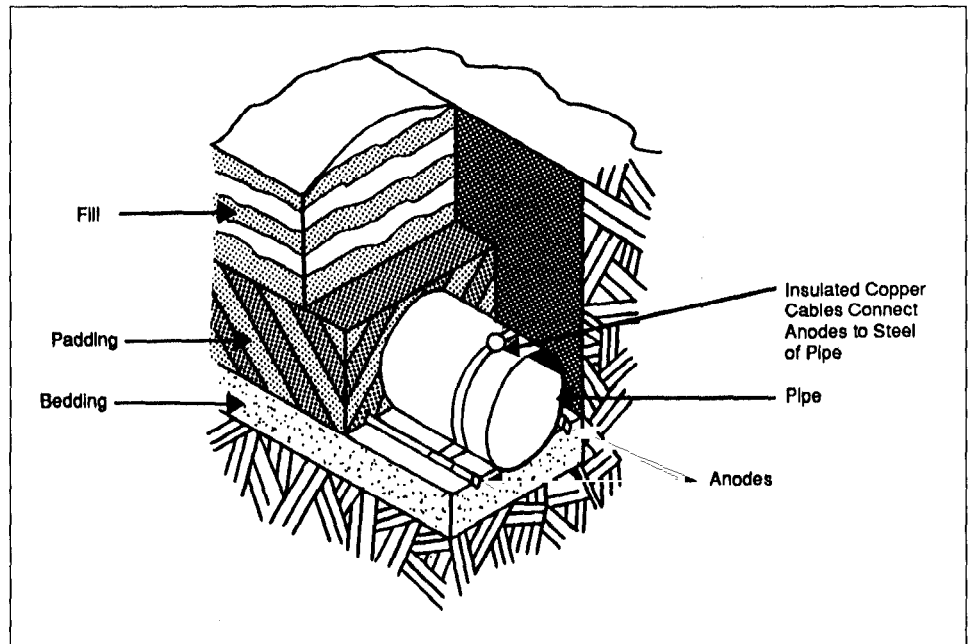

Source: GAO and Alyeska.

Finally, Alyeska used automated measuring devices called "smart pigs" that travel inside the pipeline to detect possible corrosion.

¹Cathodic protection is a means of protecting a buried steel pipe against corrosion. A current is directed onto the pipe by sacrificial anodes (metal ribbons) placed in the ground, in this case, parallel to and connected to the pipe. Pipe will not corrode if sufficient current flows onto the pipe.

Chapter 2
Regulators Did Not Ensure That Special
Requirements Intended to Lessen the
Potential for Oil Spills Have Been Met

Interior,² on behalf of the federal government, and the state approved Alyeska's system for preventing and detecting corrosion before the pipeline began operating. However, neither the cathodic protection system nor the corrosion-detecting pigs had been used on a pipeline the size of TAPS or under harsh arctic conditions. In addition, during the pipeline's construction, Interior identified hundreds of instances of damaged or improperly installed tape and epoxy coatings along the pipeline. As a result, although not normally required of pipeline operators, Transportation recommended that Interior require periodic pig surveys as part of Alyeska's corrosion detection measures. Although Interior issued non-compliance reports, it allowed these sections of the pipeline to be buried without repairing the coating and taping because Alyeska assured Interior that the cathodic protection system and the corrosion-detecting pigs would adequately guard against or identify emerging corrosion conditions. BLM's reports that summarize the noncompliance reports indicate that 96 instances of noncompliance were noted in the construction section where TAPS is experiencing its most severe corrosion problems.³ The coating and taping deficiencies found at this location are consistent with those identified in the summary reports covering the other sections of the pipeline. Nevertheless, Interior did not require Alyeska to assess whether the cathodic protection system designed for TAPS could protect the pipe from external corrosion in areas of damaged coating and taping.

Before 1988, Alyeska was only able to identify corrosion where a 50-percent loss in pipe wall thickness occurred because of the way the pig data were interpreted. In 1984, Alyeska initiated a worldwide search for improved corrosion detection technology and in 1988 and 1989 began using two newly developed or improved corrosion-detection pigs as well as reinterpreting data from the pigs. One of the pigs has the capability of detecting a 30-percent loss in pipe wall thickness; the other is designed to detect a wall-thinning of as little as 10 percent. In addition, Alyeska is working with the designer of the new corrosion-detection pig to further improve detection capabilities.

As of October 1989, using these improvements, Alyeska identified 827 anomalies, or locations where there was potential external corrosion along the pipeline. Only 14 had been identified in 1987. As of September 30, 1990, Alyeska's field inspections, which included digging up sections

²Interior's Alaska Pipeline Office provided the first Authorized Officer for TAPS; BLM assumed this role in the early 1980s.

³This figure is based on spot checking 35 percent of the 38.5 miles of pipe that was buried in that section.

Chapter 2
Regulators Did Not Ensure That Special
Requirements Intended to Lessen the
Potential for Oil Spills Have Been Met

of the pipeline, confirmed that corrosion was occurring at 65 percent of the 562 anomalies investigated and found that most corrosion was concentrated at 4 buried sections of the pipeline. After studying the corrosion found in 1988 and 1989, an Alyeska official reported that no cathodic protection system can protect buried pipe under conditions where the coating and taping have disbanded.

Of the four sections where corrosion is concentrated, an 8.5-mile stretch of pipeline lying under the Atigun River floodplain has been the most affected. Thirty-six percent of the anomalies occur at this location. The corrosion found there was serious enough for Alyeska, as of November 1989, to place steel sleeves⁴ around nearly 415 feet of the pipeline. Alyeska is replacing the 8.5-mile section in the Atigun River floodplain and is investigating the possibility of reconditioning or replacing the other three sections within the next 2 to 5 years.

In addition to the external corrosion found along the pipeline, in 1988 Alyeska discovered internal corrosion in certain sections of pipe within the pump stations that experience only an occasional movement of oil. These corroded pipe sections are commonly referred to as "deadlegs." Alyeska officials told us that this internal corrosion is caused by water carried by the crude oil settling in the bottom of the pipe during periods when the pipe is not used. Alyeska has identified approximately 1,200 areas suspected of having internal corrosion and has initiated an inspection program to locate corrosion and identify needed corrective actions. Corrective actions include eliminating the deadlegs by periodically flushing the pipes with oil, adding chemical inhibitors to reduce the likelihood of corrosion, or replacing the pipe. Alyeska completed repairs at pump station No. 3 in 1990. Alyeska spent \$47 million in 1990 and plans to spend \$70 million to \$80 million over the next 5 years to correct this problem at the remaining pump stations.

Regulatory Oversight Was
Characterized by
Complacency

The combination of damaged pipeline coating and taping and corrosion prevention and detection measures that had not been used on a pipeline such as TAPS should have warranted close regulatory attention. However, until Alyeska identified corrosion in 1989, we found no evidence of independent regulatory follow-up to assess whether Alyeska's corrosion prevention and detection system was working as planned or required modifications after pipeline operations began. Regulatory agencies did

⁴A total of 126 full-encirclement repair sleeves were used to repair the line; the longest of these sleeves is almost 140 feet; the average length is almost 29 feet.

Chapter 2
Regulators Did Not Ensure That Special
Requirements Intended to Lessen the
Potential for Oil Spills Have Been Met

not monitor areas identified by noncompliance citations to determine whether these areas were experiencing corrosion or require Alyeska to provide special attention to these areas. Instead, BLM, Transportation, and Alaska's Department of Natural Resources accepted Alyeska's data and reports indicating that the corrosion prevention and detection system was working.

Federal and state regulators have developed a plan to monitor corrosion and, along with Alyeska, are investigating the cause of corrosion at the four sections where it is concentrated. Preliminary indications are that two factors contribute to the corrosion problem. First, the epoxy protective coating and taping placed on the buried pipe during construction disbonded in some places, thus creating a space for moisture to collect between the bare metal pipe and the coating. Alyeska believes that the cathodic protection system, designed to protect the pipe against corrosion, was unable to protect these spaces because the disbonded coating acted as a shield. Second, the state of Alaska has noted that the protective coating and taping on the pipe had been penetrated by sharp rocks in numerous locations along the pipeline, exposing bare metal to corrosive soil conditions.

BLM, Transportation's Office of Pipeline Safety, and Alaska's Department of Natural Resources began monitoring Alyeska's corrosion prevention and detection system in January 1990. The initial priorities of the monitoring program are to review the cathodic protection system and causes for corrosion along the pipeline and at the pump stations. In addition, the state of Alaska is reviewing old construction records as well as inspecting pipeline sections to determine whether improperly applied taping and coatings may have contributed to the existing corrosion problems. In addition, in commenting on a draft of this report, Transportation indicated that in December 1990, after independently assessing wall-thickness data provided by Alyeska, Transportation denied Alyeska's request to increase operating pressure in the Atigun Pass area.

Regulators Have Not Required That the Computerized Leak Detection System Be Tested

The federal and state right-of-way agreements require that TAPS have a leak detection system—the first line of defense for protecting the environment in the event of a pipeline spill. Although Transportation's pipeline safety regulations do not specify that pipeline operators have an automated leak detection system, they do require procedures to deal with conditions such as leaks. Transportation essentially enforces what the operator says it will do to comply with the requirement as outlined in its required operations and maintenance plan. Alyeska's approved leak detection system includes two continuous computerized systems for detecting large and small leaks as well as visual surveillance. However, neither BLM, Transportation's Office of Pipeline Safety, nor Alaska's Department of Natural Resources have required Alyeska to demonstrate in a test whether the computerized systems work. None of the spills that have occurred along the pipeline since operations began in 1977 were initially detected by Alyeska's computerized systems.

Leaks Can Be Detected in Several Ways

Alyeska's computerized systems, supplemented by visual surveillance, are designed to detect large, high-volume leaks, such as a major rupturing of the pipeline as well as slow, low-volume leaks, such as might occur from a small hole caused by corrosion or a puncture. Alyeska defines high-volume leaks as those losing 0.8 (or greater) percent of the daily amount of oil flowing through the pipeline. At an average flow of 2 million barrels per day, this loss would equate to a rate of 16,000 or more barrels of oil per day. The high-volume computerized leak detection system is designed to detect and locate these high-volume leaks because they cause flow or pressure changes in the pipeline. For example, the system indicates that a leak has occurred when less oil reaches a downstream pump station than what left the previous station or when there is a significant drop in operating pressure between pump stations. These conditions are monitored continually for each pump station as well as at the Valdez terminal operations control center.

Alyeska defines low-volume leaks as those losing less than 0.8 percent of the daily amount of oil flowing through the pipeline. Alyeska's computerized line volume balance system is designed to detect leaks of as little as 0.15 to 0.3 percent of the daily amount of oil flowing through the pipeline. At an average flow of 2 million barrels per day, the system is designed to identify a leak of as little as a rate of 3,000 to 6,000 barrels per day by comparing the amount of oil moving into the pipeline at pump station No. 1 with the amount moving out of the pipeline at the Valdez terminal. The system adjusts for oil input and output activities along the pipeline as well as oil temperature and pipeline pressure

changes. Through a mathematical computation every 30 minutes, the system compares changes in the measured amount of oil with calculated expected values and compares the differences with a long-term trend and leak alarm threshold. If the threshold is exceeded, the system triggers an alarm. The system generally does not, however, identify where a leak has occurred. In most cases, the exact location must be determined by visual surveillance.

Alyeska also uses aircraft overflight observations—daily if weather conditions permit—combined with on-the-ground observations by pipeline personnel to augment the computerized detection systems. According to Alyeska officials, visual surveillance of the pipeline is important because a leak can often be visually detected before it is detected by the computerized systems. However, visual surveillance of the pipeline is not always possible. Although previous pipeline leaks have been discovered through visual surveillance, Alaska's climatic conditions can work against timely visual leak detection. For example, during the winter months, daylight is often less than 6 hours, reducing the time available for visual surveillance. There are also days when the pipeline cannot be observed because of inclement weather, such as blizzards or heavy rainstorms. Alyeska surveillance reports show that the mountainous Atigun Pass in northern Alaska and the Thompson Pass, near Valdez, are particularly difficult to observe. Low cloud ceilings often prevent low-level flights over these areas for a few days at a time, and snow accumulations of over 20 feet during the winter could make it very difficult to visually detect small leaks.

The Computerized Systems' Capability to Detect Leaks Has Not Been Demonstrated

Regulators have never required that the computerized leak detection system be fully tested to see if it works at the approved alarm threshold. The threshold at which Alyeska's computerized leak detection system sounds an alarm is particularly important because as mentioned above, visual surveillance of the pipeline is not always possible. Since TAPS' startup in 1977, there have been 14 spills along the pipeline system ranging from a single barrel of oil leaking from a valve fitting to 15,000 barrels spilling from a hole blown in the pipeline by a saboteur. As designed, the computerized system should have triggered an alarm for the 6 spills that exceeded the 750 barrels-per-day threshold in effect at the time of those spills. However, none of the spills triggered a leak alarm—all were discovered by visual surveillance.

As originally designed by Alyeska and approved by Interior and the state, the computerized leak detection system for low-level leaks was

Chapter 2
Regulators Did Not Ensure That Special
Requirements Intended to Lessen the
Potential for Oil Spills Have Been Met

designed to alert pipeline operators if leakage along the pipeline was 750 or more barrels per day. However, Interior and BLM have approved modifications to the leak detection system at Alyeska's request, with the result that under most current operating conditions, it would take a leak at a rate of over 3,000 barrels per day to trigger an alarm.

In August 1978, after the computerized system failed to detect the 15,000-barrel spill, Interior requested that Alyeska either improve the low-level computerized leak detection system to meet the approved design with an alarm threshold of 750 barrels-per-day or request a temporary waiver from the requirement. In response, Alyeska requested to change the system's alarm threshold to a floating rate based on pipeline operations. The 750 barrel-per-day threshold had been based on operating conditions of other smaller pipelines and, according to Alyeska, had resulted in an unacceptable number of false alarms. Interior approved the change to a floating alarm threshold and in 1980 reported improvements in the accuracy of the system to detect leaks, but stated that only time and experience would demonstrate if the system were capable of detecting spills. Since 1982 the system has been upgraded with better hardware, instrumentation, and software that provide more sophisticated analysis of data.

In responding to a July 1989 inquiry from Transportation, Alyeska reported that 3,000 barrels per day is the typical alarm threshold level at a normal throughput of 2 million barrels per day, although it can be as low as 600 barrels per day under extremely stable operating conditions. However, we found that Alyeska's monthly reports showed that at times, higher threshold levels were needed to trigger an alarm. From August 1988 through August 1989, Alyeska's reports indicated that on the basis of typical oil throughput, the alarm threshold levels ranged from 3,000-6,000 barrels per day (although it was sometimes under 1,000 barrels) to sometimes over 12,000 barrels per day. Nevertheless, no federal or state regulatory agency has required Alyeska to test the system's alarm threshold level.

Since the Exxon Valdez oil spill and the discovery of corrosion along the pipeline, BLM, the Alaska Departments of Natural Resources and Environmental Conservation, and Alyeska have reviewed leak detection systems used by other pipelines to identify possible improvements to TAPS' computerized leak detection system. Among other things, the group recommended that the low-level computerized leak detection system be tested. According to BLM and the state, this test has been scheduled for July 1991.

Regulators Did Little to Monitor Alyeska's Efforts to Address Geologic Hazards

TAPS regulators have not systematically assessed how well TAPS' designs and Alyeska's surveillance and maintenance programs have performed. This assessment is critical because numerous areas along the TAPS route and at the Valdez terminal are constructed in areas with unstable slopes and/or earthquake faults and are susceptible to damage from landslides or rockslides. Permafrost thawing and stream erosion also may pose a risk to the pipeline. Because of these potential hazards, the TAPS right-of-way agreements imposed (1) special design and construction measures to protect the pipeline and (2) surveillance and maintenance programs to assess how well these are functioning.

Slope Stability

Sections of the pipeline and the terminal are constructed in areas that are susceptible to rockslides, avalanches, or landslides. The federal and state right-of-way agreements generally required Alyeska to avoid areas susceptible to mass earth movements in routing the pipeline and locating the terminal, but where unavoidable, design measures were to be taken to protect the pipeline and terminal. Rockslides and landslides are generally triggered by earthquakes,⁵ but they also occur because of unstable natural conditions in rock structures and water drainage.

Although a January 19, 1991, risk assessment⁶ confirms that the probability of an earthquake or unstable slopes affecting the pipeline in any given year is low, if such an event were to occur, rockslides, avalanches, or landslides along the pipeline route would likely damage or rupture the pipeline and/or obstruct access roads. At the Valdez terminal, the foundations for many of the major facilities are built on flat terraces cut out of bedrock slopes. Rockslides or landslides from these slopes could damage a number of major facilities at the terminal, including the ballast water storage tanks, the power plant buildings, and some of the oil storage tanks.

The potential collapse of rock slopes, some of which are nearly vertical, was of great concern during design and construction. To stabilize the slopes along mountainous sections of the pipeline route, Alyeska cut the slopes in such a way to minimize collapse and installed water drainage systems. To stabilize the slopes at the terminal, Alyeska cut the slopes,

⁵The U.S. Geological Survey notified the state of Alaska that one or more major earthquakes near magnitude 8 on the Richter scale, nearly equal in force to the great 1964 Alaskan earthquake, is due in the Valdez area and could take place at any time. The Valdez terminal was designed to withstand an earthquake of a magnitude of 8.5.

⁶The seismic risk portion of this assessment did not include the Valdez area.

drilled hundreds of 30-foot steel bolts into the rock walls, and installed water drainage systems to reduce groundwater pressure at the base of the slopes to allow water to drain more easily, thus keeping the slopes stable during earthquakes or periods of heavy rainfall. The water drainage systems were equipped with water saturation meters designed to measure their effectiveness. Each year, Alyeska visually inspects the bolts on the rock faces, some of which are 100 feet or more above viewing level.

Permafrost Thaw

Much of the pipeline route is over permafrost. Because the oil travels through the pipeline at high temperatures—well over 100 degrees Fahrenheit—frozen areas can thaw, which makes the ground soft and pipeline supports, whether they are above or below ground, unstable. The right-of-way requirements specified conditions under which the pipe either had to be elevated above ground or buried.

To prevent the pipeline's heat from thawing surrounding permafrost, buried sections of pipeline are sometimes surrounded by refrigeration units, and many of the above-ground supports (called vertical support members) holding the pipe were designed with two built-in heat exchangers to dissipate heat. (See fig. 2.2.)

Figure 2.2: Vertical Support Member

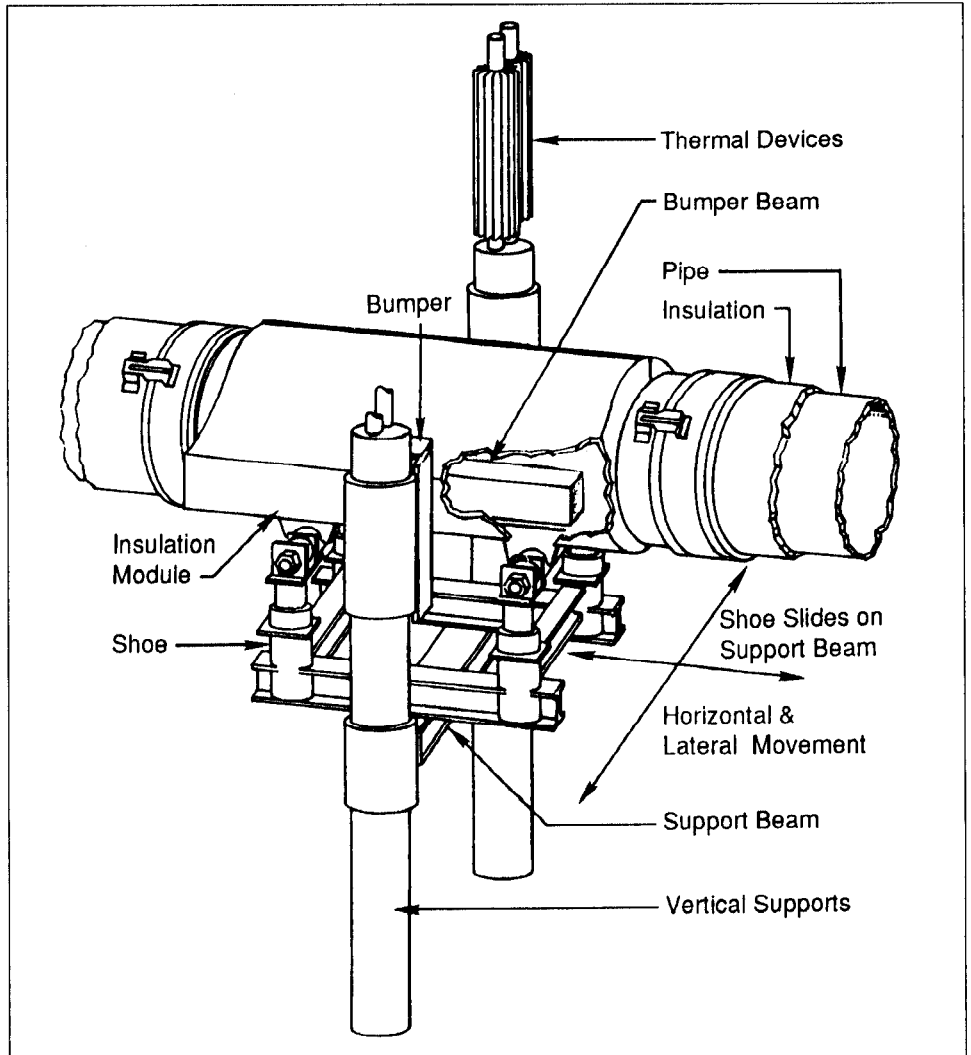

Source: GAO and Alyeska.

The federal and state right-of-way agreements require that Alyeska have a comprehensive surveillance and monitoring program to detect pipeline deformations resulting from ground thawing or other soil instability. Alyeska's program includes surveys twice annually using a pig to measure pipeline deformation caused by subsidence, field surveys to measure elevation changes of special rods connected to the buried pipeline, annual visual surveillance and field surveys of the nearly 78,000 vertical support members holding above-ground pipe, and periodic collection of information on permafrost temperatures.

River Erosion

The pipeline route crosses over 800 rivers and streams. To help protect the pipeline against damage, the federal and state right-of-way agreements required that when placed underneath stream crossings and floodplains, the pipeline was to have at least 4 feet of cover.⁷

To help guard against damage from erosion, Alyeska officials told us they survey 104 major river and stream crossings every 3 to 5 years to measure cover depth and changes in the river paths. In addition, they annually survey each river and stream crossing for erosion and routine maintenance problems. According to Alyeska, this survey enables them to determine whether erosion is occurring and to take appropriate corrective measures.

Regulators Did Not
Systematically Oversee
Alyeska's Assessment of
Geologic Hazards

Although the pipeline was designed and constructed to protect it from geologic hazards, to the extent possible, the regulators did little to systematically assess how well these designs and Alyeska's surveillance and maintenance programs have performed. BLM officials told us they visually survey the pipeline, but neither BLM nor the Alaska Department of Natural Resources had systematically reviewed how well TAPS' design has held up or the adequacy of Alyeska's surveillance and maintenance program. In commenting on a draft of this report, Transportation indicated that in 1989 it assessed Alyeska's program to monitor pipeline settlement and found it to be effective.

The regulators have not assessed the adequacy of Alyeska's procedures to monitor slope stability at the Valdez terminal or along portions of the pipeline although Alyeska's records indicate that it has experienced some difficulty with measures it put in place to address slope stability. For example, Alyeska's records indicate that 16 of 69 water saturation meters, designed to be used in conjunction with the drainage pipes to monitor the terminal's slope stability, were not working. In addition, a September 1990 study conducted for Alyeska on slope stability at the terminal recommended repair or replacement of meters along with other remedial rock-bolting and water drainage protection measures estimated to cost about \$225,000. A second study, completed for Alyeska on January 2, 1991, assessed the slope stability along certain portions of the pipeline. It concluded that the slopes are in relatively good shape but recommended that at Keystone Canyon significant rockfalls, approximately 40 feet in height, be excavated to relieve the pressure of added weight over the buried pipe. In addition, the study found that in

⁷Cover includes sediment such as sand, gravel, rocks, or even cement weights.

Thompson Pass, portions of the concrete protection measures, intended to provide stability in the mountainous region, had deteriorated. The study recommended its replacement as well as the installation of water drainage systems.

In places where the pipeline was built above ground, some settlement has occurred in the pipeline's vertical support members. Other than visually observing the pipeline, the regulators have not systematically examined Alyeska's actions to address this concern. Alyeska's records indicate that between 1987 and early 1990, over 250 of the 78,000 vertical support members needed adjustments because of settlement or heaving. This shifting in the vertical support members may have resulted from permafrost melting or a combination of other unstable ground conditions along the pipeline. In this regard, Alyeska data showed that nearly all of the heat exchangers, designed to keep the permafrost from melting, were partially blocked, which potentially reduced their capacity to dissipate heat. Under its heat exchanger repair program, Alyeska removes the blockages when they approach the heat exchangers' design specifications. Because of a redundant system built into the heat exchanger design, Alyeska does not believe that the consequences of the blockages are dire; nevertheless, it has increased its surveillance. In addition, since 1975 it has conducted studies of the vertical support members and taken ground stabilization measures in at least four of the most vulnerable pipeline sections.

Last, although Alyeska performs surveys, and BLM officials told us they visually inspect waterways for signs of river erosion, the regulators have not conducted an overall analysis of the possible impact of river erosion on the pipeline. Because of the braided and meandering nature of river systems in Alaska's flood plains, many changes have occurred to the pattern of river channels since the pipeline's construction, including changes to the flow levels and the location of channels. These changes can affect the amount of pipeline cover. For example, at three different locations, flooding washed away cover, thus exposing the pipeline to damage. No oil was spilled, and repairs were made.

Terminal Storage Tank Integrity Was Not Reviewed

While Alyeska is expected to operate the oil storage tank facility to meet various requirements, regulatory oversight was cursory at best. For example, although there have been concerns regarding the integrity⁸ of the tanks—specifically concerning corrosive conditions that could damage the tanks—the regulators did not oversee Alyeska’s efforts to address these concerns. Because of concern for the tanks’ integrity, they were designed and constructed to comply with a wide variety of design, special engineering, and environmental requirements. The 18 oil storage tanks at the Valdez terminal have a capacity of about 9 million barrels of crude oil. (See fig. 2.3.)

⁸That is, assurance that the tanks are tested and are in compliance with industry or other specified standards.

Chapter 2
Regulators Did Not Ensure That Special
Requirements Intended to Lessen the
Potential for Oil Spills Have Been Met

Figure 2.3: View of the Valdez Terminal

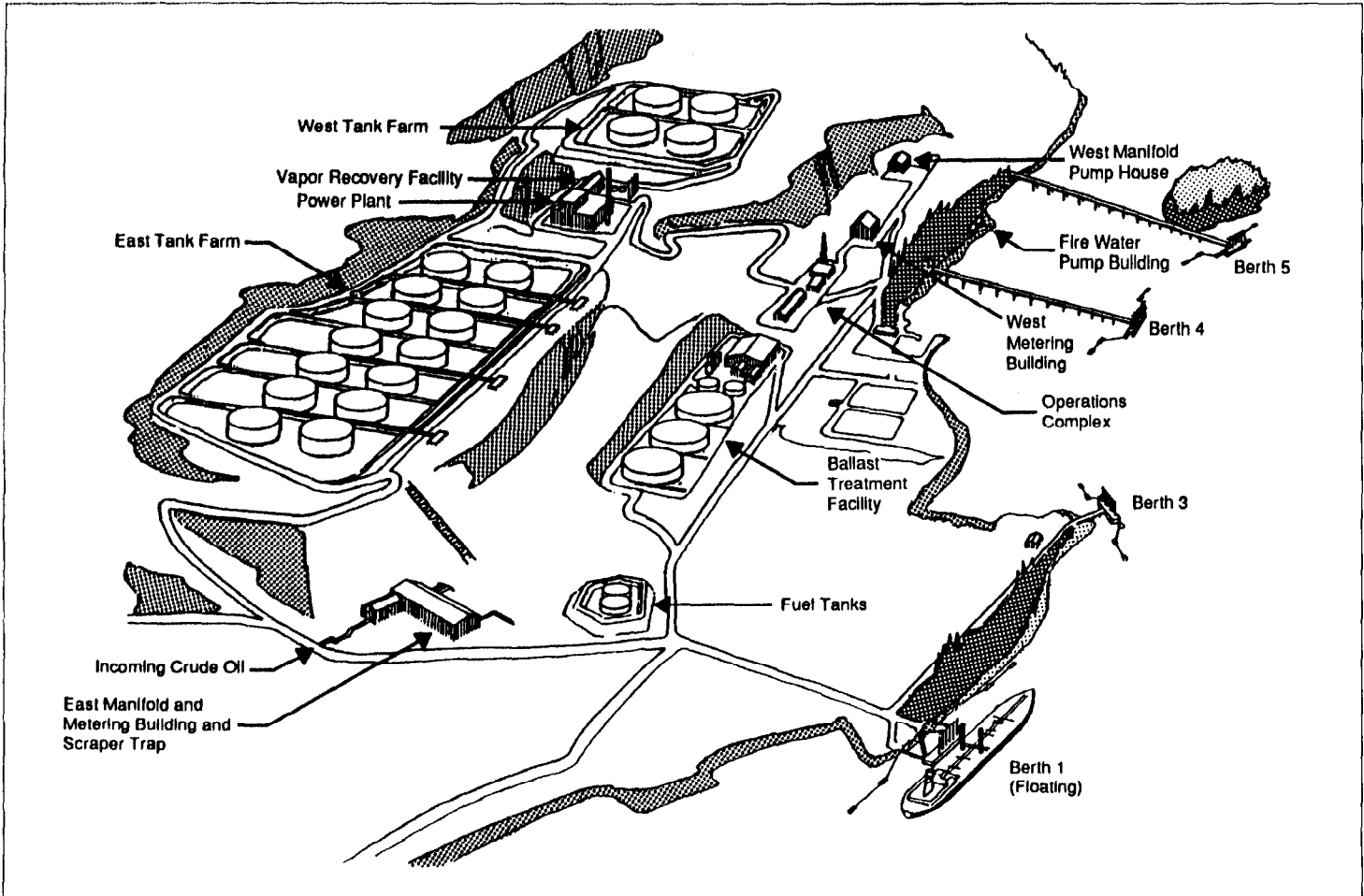

Source: GAO and Alyeska.

Although all five regulatory agencies have some role at the terminal, with the exception of EPA's and the Alaska Department of Environmental Conservation's air and water quality permits, there was little regulatory oversight of terminal operations. In particular, no agency ensured that the 18 crude oil storage tanks were in conformance with requirements. This regulatory inattention occurred, in part, because the regulators were uncertain of who had jurisdiction for monitoring the tanks.

Alaska Department of Natural Resources officials, responsible for enforcing the right-of-way agreement at the terminal, said they relied on

Chapter 2
Regulators Did Not Ensure That Special
Requirements Intended to Lessen the
Potential for Oil Spills Have Been Met

other federal and state regulatory agencies to monitor terminal operations. Although Transportation's Office of Pipeline Safety and EPA are authorized under the Hazardous Liquid Pipeline Safety Act and the Clean Water Act, respectively, to regulate and inspect the tanks to ensure their structural integrity, neither agency has done so. According to a 1971 memorandum of understanding between EPA and Transportation, EPA was to assume responsibility for the integrity of the storage tanks but has not done so. EPA has regulations in place as part of its Spill Prevention, Control, and Countermeasures Program, but according to EPA officials, existing regulations are subject to interpretation and have not always been met in the past. Accordingly, EPA is in the process of clarifying those regulations to ensure that mandatory testing of the tanks' integrity as well as other requirements are met.⁹

According to a 1982 U.S. Geological Survey report,¹⁰ the asphalt liner that lies beneath the storage tanks was damaged by excessive groundwater pressure during construction, creating a space for moisture to collect. Nevertheless, before 1989, after inspecting three tanks, Alyeska reported minimal or no tank corrosion. In 1989, Alyeska, using new, more sensitive detection instruments, identified pitted areas covering about 1 percent of the surface in two tanks where corrosion had penetrated half of the tanks' quarter-inch-thick metal bottom plates. As a result, Alyeska has stepped up the pace of its inspections and plans to inspect all 18 tanks by 1995. As of October 1990, Alyeska had inspected an additional three tanks and found corrosion. Two of the three tanks required repairs—covering a total of 9 square feet and 83 square feet, respectively. In commenting on a draft of this report, the state indicated that it has begun monitoring Alyeska's schedule for repairing corrosion found in the terminal storage tanks and at the pump stations.

BLM does not believe that it has direct regulatory authority over the storage tanks or most other terminal operations. However, under the state's right-of-way agreement, BLM has full access to the terminal to enforce federal right-of-way requirements. We believe that since terminal operations are an integral part of TAPS' operations that affect the

⁹In our report, Inland Oil Spills: Stronger Regulation and Enforcement Needed to Avoid Future Incidents (GAO/RCED-89-65, Feb. 22, 1989), we recommended such action.

¹⁰Design Review, Trans-Alaska Oil Pipeline, 1974-1976, U.S. Geological Survey Open File Report 82-225, 1982. Additionally, a September 1990 study completed for Alyeska found that groundwater pressures were affecting the east farm tank foundations, asphalt liners, and in all probability, the steel tank bottoms. The study concluded that some of the water drainage measures were not effective.

federal portions of the pipeline's right-of-way, in the absence of monitoring by other regulators, BLM could have and should have stepped in.

Conclusions

In retrospect, the five federal and state agencies responsible for monitoring and assessing TAPS' operations should have played a more active role in fulfilling their oversight responsibilities. While Alyeska is responsible for meeting various regulatory requirements, federal and state regulatory agencies are required to ensure that the actions Alyeska takes are adequate. Previously undetected pipeline, pump station, and storage tank corrosion; a computerized leak detection system that has not been tested to see if it works at approved alarm thresholds; not knowing how effective TAPS' design and Alyeska's surveillance and maintenance program have been in assessing the potential damage from geological hazards; and limited oversight of the Valdez terminal's operations and facilities indicate a lack of thorough oversight by regulators. In the wake of the Exxon Valdez oil spill and the discovery of corrosion along the pipeline, regulatory agencies have begun to take action. They have developed a corrosion work plan and have reviewed Alyeska's leak detection system. However, more needs to be done to successfully fulfill their oversight responsibilities and to ensure the long-term continued safe operation of the pipeline system.

Recommendations

To ensure that TAPS is standing up to the special engineering design and operating requirements intended to lessen the potential for oil spills, we recommend that the Secretary of the Interior and the Secretary of Transportation, in cooperation with the state of Alaska (where appropriate),

- reassess the adequacy of Alyeska's corrosion prevention and detection efforts, including (1) the cathodic protection system intended to protect the pipeline from corrosion and (2) plans to better detect and correct internal and external corrosion along the pipeline and at the Valdez terminal and
- require Alyeska to test its leak detection system at various levels of pipeline operations to determine what levels of leakage will trigger an alarm and decide if these leak detection threshold levels meet approved design levels.

We recommend that the Secretary of the Interior, in cooperation with the state of Alaska,

Chapter 2
Regulators Did Not Ensure That Special
Requirements Intended to Lessen the
Potential for Oil Spills Have Been Met

- improve monitoring and evaluation of Alyeska's efforts to assess and mitigate geologic hazards along the pipeline and at the terminal, including those intended to (1) stabilize the rock slopes at the terminal and along mountainous sections of the pipeline, (2) safeguard permafrost, and (3) guard against potential damage to the pipeline as the result of river erosion.

In addition, we recommend that the Administrator of EPA

- revise its regulations to ensure oversight of the integrity of crude oil storage tanks.

Agency Comments

In commenting on a draft of this report, Transportation, EPA, and the state indicated that they essentially agreed with our assessment of their oversight before the Exxon Valdez incident. Interior believes that it has performed its oversight function adequately. However, Interior, Transportation, EPA, and the state indicated that they are already acting on our recommendations. The joint office is assessing Alyeska's corrosion detection and prevention systems, is monitoring Alyeska's corrosion repair program, plans to test the leak detection system, and has indicated that it plans to more adequately oversee geologic hazards. In addition, EPA is in the process of revising its regulations regarding storage tank integrity. If properly implemented, these actions should address the intent of our recommendations.

Oil Spill Response Capability Not Fully Demonstrated

Alyeska's ability to respond to a large-scale oil spill along the pipeline or at the terminal is not known. The well-publicized problems encountered by both industry and government in responding to the Exxon Valdez oil spill indicate that adequate preparation is crucial to minimize the impact of an oil spill on the environment. A well-designed plan and demonstrated capability to locate, contain, and clean up spilled oil are integral parts of emergency response preparation. Although the Valdez terminal component of Alyeska's oil spill contingency plan has undergone more rigorous review than other parts of its plan, regulatory review of other plan components was cursory until after the Exxon Valdez oil spill. In addition, because the testing of Alyeska's response capabilities has been limited, neither Alyeska nor the regulatory agencies know whether the resources and equipment identified in the plan are adequate or can be promptly mobilized and deployed to respond to a large-scale spill.

After the Exxon Valdez oil spill, a committee including Alyeska, BLM, and the Alaska Departments of Natural Resources and Environmental Conservation, respectively, reevaluated spill risks and oil spill response capabilities. In addition, federal and state regulators, including BLM and the Alaska Departments of Natural Resources and Environmental Conservation, inspected the pipeline and identified deficiencies in Alyeska's oil spill response capabilities and have worked with Alyeska to draft a new pipeline oil spill contingency plan. However, the regulators do not plan to fully test Alyeska's response capabilities by requiring Alyeska to conduct a companywide drill that we believe is needed to at one time, test the leadership, coordination, communication, and equipment and personnel mobilization needed to locate, contain, and clean up a large scale spill. Interior, the state, and Alyeska believe that such a drill would require that the pipeline be shut down. In commenting on a draft of this report, the state indicated that it is planning a systemwide drill when TAPS is shut down for operational reasons.

Review of Oil Spill Contingency Plan Was Limited

With the exception of the review of the terminal, we found that until 1989, regulatory reviews had been very limited. Under the federal and state right-of-way requirements, one of Alyeska's prime responsibilities is to protect the public and the environment from the effects of an oil spill. To accomplish this, the agreements require Alyeska to, among other things, develop an oil spill contingency plan that provides for locating, confining, and cleaning up spilled oil. Alyeska is required to update the plan as appropriate and resubmit the plan to BLM and the Alaska Department of Natural Resources for approval. Additionally, the

Department of Environmental Conservation approves the Valdez terminal's plan component and under a recent state of Alaska act, received authority to approve the pipeline's plan components.¹

Alyeska's oil spill contingency plan is divided into four major components—(1) a general plan describing overall response personnel, authorities, responsibilities, and materials and supplies; (2) 11 segment plans describing the pipeline's terrain, environmental considerations, and suggested response actions to be initiated at points along the line; (3) a Valdez terminal plan outlining response actions at the terminal; and (4) a Prince William Sound plan describing response action for marine spills. Because the Prince William Sound contingency response is the subject of another GAO review concerning the Exxon Valdez oil spill, we did not address the plan in this report.²

Review of Pipeline Contingency Plan Components Was Limited

We found the annual approvals were based primarily on undocumented observations by the BLM oil spill coordinator. We also found that BLM approved the plan components even though problems it had identified were not corrected at the time the plans were approved. BLM and Alaska Department of Natural Resources officials told us they have annually reviewed and approved the general oil spill contingency plan and 11 pipeline section plan components since the first contingency plan for TAPS was approved in 1976. These officials told us that their approvals were based on their assessments of the accuracy of the information contained in the plans as well as their assessment of Alyeska's ability to carry out the response actions called for in the plans.

BLM officials told us that the original contingency plan, completed during TAPS' construction, was extensively reviewed by the regulatory agencies before it was approved. Given the extent of that review, and the fact that Alyeska had to respond to several spills over the years using the plan, BLM believed that until the Exxon Valdez incident, the subsequent, updated plans were adequate. Accordingly, BLM approved the plan on the basis of observations made by its oil spill coordinator during his field visits. BLM officials told us that the coordinator spent several months a year making field visits along the pipeline. BLM officials said that during these visits, the coordinator inventoried emergency response

¹The Department of Environmental Conservation conditionally approves the plan component for the terminal every 3 years.

²Coast Guard: Adequacy of Preparation and Response to Exxon Valdez Oil Spill (GAO/RCED-90-44, Oct. 30, 1989).

equipment for some pump stations, attended drills designed to test portions of Alyeska's emergency response preparedness, and/or discussed emergency response issues with Alyeska staff.

Although the BLM officials indicate that the oil spill coordinator spent several months in the field, we found little documentary evidence to provide a basis for the annual approvals of contingency plans. BLM officials told us that on the basis of the coordinator's observations, they believed the plans were basically adequate. The coordinator told us that he documented few of his concerns because Alyeska often responded to informal suggestions he made for improving the plans. However, we found this informal way of problem solving was not always adequate. For example, in the mid-1980s, Alyeska decreased the number of supervisors stationed along the pipeline by nearly 50 percent. The coordinator expressed his concern to BLM management and Alyeska that there would be an insufficient number of oil spill supervisors in the event of a spill. He did not draft a report on this issue, he said, because BLM management expressed little concern in pursuing the matter.

When BLM identified problems with the plans, it did not ensure that they were corrected before the plans were approved. For example, BLM approval memoranda for the 1985 and 1986 plans suggested that Alyeska improve the quality of the aerial photographs included in the plan, develop an oily waste disposal plan, and create and maintain a response team at pump station No. 7. However, only the quality of the aerial photographs had been improved in the 1987 contingency plan approved by BLM.

The Alaska Department of Natural Resources also annually reviewed and approved Alyeska's general oil spill contingency plan and the 11 pipeline section plan components. The reviews by this agency were also limited. Like BLM's reviews, there was little documentary evidence to support the approval process. The Department rarely, if ever, conducted field inspections of the pipeline to assess the adequacy of Alyeska's contingency planning efforts. Department of Natural Resources officials told us that the pipeline plans were reviewed annually by agency inspectors in coordination with other agencies including the Department of Environmental Conservation. However, a former Department of Environmental Conservation official responsible for reviewing contingency plans told us that reviews of the pipeline contingency plans, at least until 1989, were not very rigorous.

Review of the Valdez Terminal Plan Component Was More Rigorous

The Department of Environmental Conservation, on the other hand, appears to have taken a more rigorous approach in reviewing the Valdez terminal's oil spill contingency plan component. Our review of the Department's documents identified numerous reviews, including assessments of Alyeska's emergency response actions in drills and oil spill training exercises. Identified deficiencies were formally noted and had to be corrected before the Department approved the plan. For example, in November 1986, the Department expressed concern about the terminal's oil spill response capability and ordered Alyeska to demonstrate its response capability at the loading area. In that test, a Department inspector observed deficiencies in Alyeska's on-scene coordinator capabilities and ordered Alyeska to make changes to the 1987 plan before it was approved. According to an agency official, no final approval was granted for the terminal's plan in 1987. From 1987 until 1989, the terminal operated under conditional approval for the contingency plan.

Alyeska's Ability to Respond to a Large-Scale Spill Remains Unknown

The approved oil spill contingency plan states that Alyeska will conduct full-scale, companywide field exercises at least once per year to ensure overall readiness for responses to large-scale oil spills and to ensure that communications will be rapid and effective. To comply with this requirement, Alyeska conducted two companywide drills annually to locate a spill as well as section drills and training exercises along the pipeline or at the terminal to test either communications or limited equipment deployment. However, these drills did not test the full response that would be needed in the event of a major spill. The drills have not at one time, tested the leadership, coordination, communication, and equipment mobilization effort that would be needed to locate, contain, and clean up such a spill.

The scope of Alyeska's companywide drills was limited. These drills consisted of searching for a small spill, simulated by a piece of black plastic, and were discontinued after search teams reported they found the spill. There was no full-scale deployment of the containment and cleanup personnel and equipment that would be required if a large-scale oil spill were to occur. In these drill scenarios, pump station personnel were notified when the computerized leak detection system had detected a leak. Pump stations sent out teams to find the leak, and once the leak was found, the field supervisor prepared, but did not implement, a plan for containing the spill. He then notified the drill supervisor and, at this point, the companywide drill was terminated.

Alyeska officials also told us that oil spill supervisors for the northern (from Fairbanks north to pump station No. 1) and southern (from Fairbanks south to the Valdez terminal) sections of the pipeline conducted section drills that tested the command structure and communications and simulated oil spill response capabilities of company personnel within a given section. Although limited documentation was available, Alyeska officials described the drills as being more comprehensive than the companywide drills. Activities included projecting equipment needed to respond to the drill, identifying where the equipment was located, and requiring personnel to ready the equipment for movement to the simulated oil spill site and, in some cases, deploying equipment.

None of the drills simulated the pipeline's maximum potential spill—10,000 to 64,000 barrels—that would have to be contained and cleaned up in a worst-case scenario. Moreover, the companywide drills and training exercises that were documented disclosed recurring problems with Alyeska's response capabilities. However, neither federal nor state regulators have called, participated in, or regularly observed the drills and training exercises. Neither have they reviewed Alyeska's critiques of the drills, or ensured that identified problems were addressed.

Oil Spill Drills Showed Response Problems

Although Alyeska conducted some drills and training exercises and critiqued some of these efforts, the regulators had not ensured that identified problems were corrected. Alyeska's critiques of companywide oil spill response drills from 1985 through 1989 identified several recurring problems. For example, personnel sent out to locate a simulated leak along the pipeline reported problems year after year with communicating messages on search progress. Both mechanical and procedural causes for this problem were noted, including broken radios with no backup in vehicles, radios with dead batteries, incorrect operation of the radios that disrupted other surveillance transmissions, and dead zones along the line that prevented radio communication.

The critiques also indicated that it was difficult for some reconnaissance vehicles used to locate spills to effectively operate in adverse conditions along the pipeline. For example, the vehicles either did not operate well in deep snow conditions or on steep slopes, did not travel the line quickly enough, or were difficult to control while staff observed the pipeline. In addition, response personnel reported that vehicle lights were inadequate because they were either not bright enough or were directed in a way that made it difficult to see the pipeline.

Response personnel also noted difficulty in gaining access to sections of the pipeline. In some instances, Alyeska had blocked the pipeline to prevent public access, and in other instances, private property owners adjacent to the pipeline had installed fencing which limited access to the right-of-way. Reconnaissance teams sent out to locate simulated leaks have had to either dismantle or go around the fences and blockages, thus extending response time. Alyeska officials told us that because of these fences and blockages, sections of the pipeline were skipped in some of the drills.

Alyeska officials do not believe the cited problems in the drill critiques were major. They believe that communications problems were to be expected during drills and that any malfunctioning equipment was repaired. They also noted that Alyeska evaluated other reconnaissance vehicles but found nothing better than those in use. Alyeska officials told us that vehicle lighting problems were worked out and the issue of blockages along the pipeline was addressed. Company reports also indicate that personnel were instructed in proper communications procedures and radios were reported for repair.

Alyeska believes that its oil spill contingency plan has been adequate and that the annual companywide drills, section drills, and training sessions it conducted, as well as its past response to spills, have demonstrated its response capabilities. Alyeska management officials said they are confident that they will perform as expected during a major spill. BLM officials also indicated that they are confident that Alyeska's oil spill contingency plan for the pipeline is adequate.

Regulatory Oversight of Drills Was Limited

Neither BLM nor Alaska's Department of Natural Resource inspectors participated to any significant degree in or attended many of the drills. In the event of an actual spill, BLM and/or state officials are expected to be on the scene, and if they are not satisfied with Alyeska's actions to contain and clean up a spill, to direct the effort. BLM inspectors said they attended about 50 percent of the drills. However, state inspectors rarely attended. And finally, although the approved contingency plan called for Alyeska to prepare critiques after each drill and maintain them in a central location, BLM did not review these critiques. BLM inspectors told us they did not review any of the drill critiques because their review might have stifled candid comments from Alyeska field personnel to management.

Actions Taken Since the Exxon Valdez Oil Spill

Alyeska's poor response to the Exxon Valdez spill caused BLM and the Alaska Department of Natural Resources to reexamine Alyeska's pipeline oil spill response capability. Their inspections identified potential problems in equipment suitability and deficiencies in staffing levels and raised questions about training requirements.

Shortly after the Exxon Valdez accident, BLM and the Department of Natural Resources conducted linewide inspections to review the adequacy of Alyeska's oil spill response capability. Their findings were similar. Both agencies (1) questioned whether the equipment on-hand was state-of-the-art, given technological advancements since the plan was first approved, or if the equipment was properly located and (2) noted deficiencies in response personnel staffing and training.

BLM noted concern with a growing weakness in Alyeska's oil spill response capability, citing the loss of almost 50 percent of the trained oil spill response managers. The Department of Natural Resources concluded that Alyeska's staffing was "insufficient to adequately respond to a spill of any major magnitude." In addition, the Department noted that pump station staff were not sufficiently aware of their emergency response responsibilities. The Department also noted the need for more contingency storage facilities, reevaluation of vehicle capabilities, and removing unauthorized blockage along the pipeline.

Alyeska formed a committee in May 1989 with BLM and the Department of Natural Resources to study the oil spill contingency plan and prepare a revised plan. Since then, the Alaska Department of Environmental Conservation has joined the committee. The task force conducted a comprehensive analysis of the existing Alyeska oil spill contingency plan, including training, staffing, facilities, and equipment, and prepared a new plan that was approved in April 1991.

While in the process of preparing a new contingency plan, the committee recommended several preliminary improvements which are being acted upon by Alyeska. Alyeska's implementation plan calls for it to (1) add to or build new heated storage facilities for the contingency equipment; (2) hire eight more contingency response supervisory personnel; (3) update the training program, keep better training records, and provide more training for spill response personnel; (4) establish portable oil containment boom anchoring sites, prestage containment material at remote sites, and improve access to and along the rights-of-way; (5) purchase additional equipment to handle oil-contaminated snow and vegetation; and (6) purchase a new type of fireproof river boom. In addition, the

April 1991 revised plan includes the adoption of a new command system which is intended to facilitate a coordinated and systematic response mechanism.

Full-Scale Testing Needed as Part of Approval Process

While changes to the contingency plan are being implemented to improve identified inadequacies, it is still difficult to tell what impact individual changes will have on response preparedness. In order to ensure that public lands are adequately protected from the effects of an oil spill, the plan must be thoroughly tested to determine responsiveness and readiness. To date, there has been little regulatory involvement in testing the pipeline and terminal oil spill contingency plans. In commenting on a draft of this report, the state underscored the importance of being well-prepared. It stated that the absence of an adequate predesigned command structure was substantially responsible for much of the lack of organization during the Exxon Valdez oil spill response.

Although oil spill contingency plan testing guidance exists for federally regulated offshore oil producers, such testing guidance does not exist for onshore pipelines. Interior's Minerals Management Service, which regulates offshore oil and gas producers, including marine pipelines on the Outer Continental Shelf, requires lessees to demonstrate their capability to respond to oil spills by holding mobilization drills. The Service requires the lessee to submit an oil spill scenario before conducting the drill. The Service reviews the scenario and may change it in consultation with the U.S. Coast Guard to ensure that the drill will test the response measures identified in the contingency plan. The conditions of the drill must be realistic, but not necessarily worst-case, and among other things, must include the deployment of equipment. The Service may also call a drill at anytime without advance warning to the lessee. These drills are unannounced to demonstrate that the equipment is available and functional, and that crews are familiar with its deployment and operation under various conditions. The regulations also require the Service to evaluate the results of drills and advise the lessee of any necessary changes in response equipment, procedures, or strategies. Interior, the state, and Alyeska believe that such a drill would require that the pipeline be shut down.

Conclusions

Although BLM and Alyeska have expressed confidence in Alyeska's ability to respond to a large-scale spill, we do not believe Alyeska's response capability has been adequately demonstrated. First, until the

Exxon Valdez accident, major components of Alyeska's oil spill contingency plan had not undergone rigorous review, and some suggested changes had gone unheeded. Second, although required by the approved oil spill contingency plan, federal and state regulators have not required Alyeska to conduct a companywide, full-scale drill. Although Alyeska has revised and issued a new contingency plan dated April 1991, this new plan does not require a full-scale drill. We believe that such a drill would at one time, test the leadership, coordination, communication, and equipment and personnel deployment required to locate, contain, and clean up a large-scale oil leak. Further, until recently, federal and state regulators did not participate in or observe many of the drills or review the drill critiques prepared by Alyeska or ensure that the problems found were corrected. The recently approved command system should certainly improve communications and involvement of the regulators and Alyeska during drills or an actual spill. However, because of the significance of TAPS, we also believe that drills that involve the active participation of regulators, such as those required by the Minerals Management Service for offshore oil producers, would be appropriate for the regulators of TAPS.

Recommendations

To ensure that resources and equipment are adequate to respond to a large-scale leak and can be promptly mobilized and deployed, we recommend that the Secretary of the Interior, in cooperation with the state of Alaska,

- continue to periodically review and update all components of Alyeska's oil spill contingency plan as was done for the April 1991 plan;
- actively participate and observe Alyeska's oil spill drills and training exercises and require that Alyeska address deficiencies identified during these drills; and
- require Alyeska to conduct a companywide, full-scale drill that tests the leadership, coordination, communication, and equipment and personnel mobilization required to locate, contain, and clean up a large-scale oil spill.

Agency Comments

In commenting on a draft of this report, Interior and the state indicated that they are already acting on our first two recommendations. They have conducted a detailed review of Alyeska's contingency plan and a revised plan was completed in April 1991. We modified the recommendation contained in our draft report which called for an updated plan to reflect the fact that a new plan was completed in April 1991. Since we

believe that the oil spill contingency plan must be a "living document," our report now recommends that the plan be periodically reviewed and updated.

The new plan requires the regulators to be more involved in Alyeska's oil spill drills. If properly implemented, this requirement should address the intent of our recommendations on regulators' participation in drills. Regarding our recommendation for a full-scale drill, BLM, the state, and Alyeska all indicated that it would require the line to be shut down. However, the state indicated it would be possible to conduct such a drill when the line was shut down for maintenance purposes. We continue to believe such a full-scale drill is needed to demonstrate Alyeska's ability to realistically bring to bear all of the resources necessary to locate, contain, and clean up a large-scale spill.

Environmental Impacts of TAPS Not Fully Examined

A hot-oil pipeline crossing 800 miles of frozen or near-frozen ground, with its accompanying system of pump stations, haul roads, and facilities, equipment, and people affects Alaska's fragile environment. Moreover, an oil spill has both immediate and long-term environmental impacts. The protection of the environment was a basic tenet of the federal and state right-of-way agreements that require Alyeska to conduct all activities associated with TAPS in a manner that avoids or minimizes degradation of air, land, and water quality and provides protection to fish and wildlife and their habitats. To accomplish this requires a basic knowledge and understanding of (1) the environmental impacts of the pipeline in general and the impacts associated with oil spills in particular and (2) the most appropriate oil spill containment, cleanup, and disposal technologies for Alaska's arctic conditions. While many studies have been undertaken to examine the pipeline's impact on particular species and habitats, we found that no long-term monitoring program to assess TAPS' overall impact on the environment has been developed.

Long-Term Monitoring Program Is Needed

Environmental monitoring studies have generally been reactive and have focused on site-specific, recurring problems, such as localized erosion instead of long-term problems. Before TAPS' construction, Alyeska and the regulators sponsored numerous environmental studies, primarily as part of the environmental impact statement process. Since construction, Alyeska and BLM, as well as universities, other government agencies, industry, and Canada, have sponsored over 600 environmental studies. Even when taken together, the studies do not provide an overall picture of TAPS environmental impacts.

We previously reported that long-term environmental research on TAPS' impacts was not being done and characterized the status of TAPS-related environmental research as ad hoc, opportunistic, and insufficient to adequately judge TAPS' long-term effects.¹ We concluded that as a result, the regulators did not know the long-term environmental impact of TAPS and, therefore, could not ensure that the environmental requirements in the right-of-way agreements were being met. We recommended that BLM develop a list of priority research necessary to evaluate the long-term environmental impact of TAPS. Research areas we identified for consideration included the impacts on wildlife, success of revegetation, and long-term effects of oil spills on natural vegetation.

¹Trans-Alaska Oil Pipeline Operations: More Federal Monitoring Needed (EMD-81-11, Jan. 6, 1981).

The U.S. Fish and Wildlife Service reached a conclusion similar to ours in a 1987 draft report,² on the environmental impacts of oil development in Alaska, including Prudhoe Bay and the northern sections of the pipeline. The report noted that long-term monitoring studies are critical to both minimize anticipated impacts and maximize the timely assessment of unexpected impacts. The report also noted that while some impacts may individually be insignificant, when considered cumulatively, they can be significant. According to the Fish and Wildlife Service, the size of the TAPS project and the complexity of the ecological systems that it affects justify analyzing the pipeline's cumulative impacts. The report concluded, however, that TAPS' biological monitoring has been reactive and tends to focus on site-specific correction of recurring environmental problems.

BLM neither developed a list of priority areas of environmental concern nor ensured that long-term studies explored these concerns. The Authorized Officer told us that BLM has not seen a need for such studies because few environmental concerns have been identified during pipeline monitoring and because few pipeline oil spills have occurred. However, in its agency comments on a draft of this report, Interior stated that environmental impact statements have recently been completed for two gas projects to be built in the TAPS corridor and a land use plan has been developed that includes part of the TAPS corridor. Although these studies may have some information on the pipeline's environmental impacts, they were not part of a systematic assessment of the pipeline's cumulative impact. In addition to these recent studies, in commenting on a draft of this report, Interior indicated that the joint office is in the process of developing a data base of existing studies.

More Oil Spill Research Is Needed

We also found that a number of data gaps exist on the adequacy of inland oil spill cleanup information relative to TAPS. However, neither BLM nor the Alaska Department of Natural Resources has required Alyeska to develop this information. These data gaps include the need to assess the environmental effects of spilled oil; alternative inland arctic spill treatment technologies, including cleanup and control; and oil spill waste disposal methods.

²Comparison of Actual and Predicted Impacts of the Trans-Alaska Pipeline System and Prudhoe Bay Oil Fields on the North Slope of Alaska, draft report, U.S. Fish and Wildlife Service, 1987. According to agency officials, this report was not finalized because of other priorities.

In commenting on a draft of this report, the state indicated that as a result of the findings of a task force that reviewed Alyeska's oil spill contingency plan, oil spill clean up techniques and mitigation methods will be studied. EPA also indicated that it is studying various cleanup technologies.

Environmental Effects of Spilled Oil Need to Be Assessed

Both government and industry recognize the need to study the environmental effects of spilled oil and oil spill treatment methods. Information gained through such studies can be used to better respond to future spills. However, we found that little is known about the toxicity of oil on northern life forms—arctic and subarctic plant and animal species—and recommended the studying of past spill sites to gain such knowledge.

Research on the environmental effects of spilled oil on arctic and subarctic soils and streams could help provide regulators with a basis for developing realistic cleanup standards. Neither federal nor state laws and regulations include specific standards for cleaning up crude oil spills. Alaska state officials recognize that totally removing spilled oil is often either not technically feasible or economically possible. In this regard, in January 1990, the Department of Environmental Conservation developed interim guidelines for cleaning up soil damaged by oil spills until the state can develop formal standards for cleanup levels. A department official told us that additional research would help in developing such standards.

Alternative Oil Spill Treatment and Cleanup Methods Need to Be Considered

Interior's Outer Continental Shelf (OCS) Policy Committee³ noted that the Exxon Valdez spill and other spills have illustrated the need to explore and develop new technologies for effectively containing and recovering oil that is spilled on water and land. In commenting on a draft of this report, EPA indicated that it has convened a committee to look for ways of using bio-remediation for cleaning up oil spills and has several research and development projects underway.

We also found that there is a need to develop new technologies for containing and cleaning up oil spills in arctic and subarctic conditions. For example, current industry-accepted methods include building dikes and

³The OCS Policy Committee advises Interior on discretionary functions of the OCS Land Act, including all aspects of leasing, exploration, development, and protection of the natural and mineral resources of the OCS.

excavating contaminated soils. However, building earthen dikes around a spill site could melt the permafrost. In the event of a large spill, this melting condition could cause the oil to spread over a greater area and containment could prove difficult. Restoration could also be difficult and may threaten pipeline support structures. In addition, spills that enter Alaska's fast-moving rivers and spread under ice during winter months present unique containment and cleanup problems. Relying on excavation as the primary cleanup measure assumes that there are government-approved waste disposal areas nearby that can handle large volumes of contaminated materials. Since there are no approved disposal sites in Alaska, relying on excavation as a cleanup measure is impractical. Cleaning up large oil spills requires the disposal of large amounts of oil-soaked materials, such as absorbents used during cleanup, and contaminated logs, branches, and soil.

We identified five major emerging oil spill waste disposal technology areas which, with further development, may represent more promising alternatives to burying or burning oil spill wastes. These include (1) physical treatment (removing oil without changing it chemically), (2) chemical treatment (using chemicals to transform spill waste into less toxic compounds), (3) biological treatment (adding micro-organisms to a spill site to transform spilled oil into harmless substances), (4) improved incineration techniques, and (5) immobilization (binding spilled oil to the soil in such a way that prevents chemical reactions, leaching, or other harmful effects).

Regulators Have Not Established Research Priorities

A systematic approach to examining TAPS' impact had not been developed. Although some TAPS environmental research needs have been identified, BLM and Alaska's Department of Natural Resources have not ranked the needs in order of priority nor have they developed plans to ensure that research is undertaken. Since the Exxon Valdez spill and Alyeska's discovery of TAPS' corrosion, federal and state agencies are placing more emphasis on the environmental impacts of TAPS. The joint office has taken the first step and has indicated that it is developing a data base of existing studies on the basis of information we provided them during the course of this review.

Research topics identified by federal and state agencies and Alyeska include in-depth research on the effects of various alternative oil spill containment, cleanup, and restoration techniques on the arctic environment, the impacts on bear and wolf populations as a result of increased hunting access, impacts of TAPS' river drainage and training structures

on fish populations and habitats, and the long-term success of revegetation and restoration at TAPS' construction sites.

The Vice President of Alyeska's Environment Division told us that Alyeska is giving greater consideration to the seriousness of environmental concerns since the Exxon Valdez spill. Alyeska is sponsoring additional marine environmental research, including the establishment of baseline data in Valdez and studies on marine sedimentation, sea otters, and salmon. Alyeska has also elevated the environmental component of its operations from a department within the Environment and Engineering Division to a separate division and increased staff positions from 9 in the fall of 1989 to 34 in January 1990.⁴ Alyeska increased its Environmental Division budget from about \$1 million in 1988 to about \$10 million in 1990.⁵

Conclusions

The pipeline, in general, and oil spills, in particular, affect Alaska's fragile environment. It is important, therefore, to understand both the pipeline's environmental impacts over time as well as the environmental consequences of oil spills to determine the degree and magnitude of these impacts. However, there is no basis to judge changes over time because no long-term systematic monitoring program has been developed.

Additionally, the environmental consequences of spilled oil require further study, including research on the toxicity of oil on northern life forms. The information gained from such research could be used to establish realistic cleanup standards. Moreover, new containment, cleanup, and disposal technologies are needed to minimize the environmental impacts of oil spills in arctic and subarctic conditions. While many projects and studies have been undertaken or recommended to address these and other research needs, no strategy exists to rank the projects and studies in priority order.

The joint office has recently begun to compile a data base of environmental studies completed to date based in large part on the list of studies we provided. We see this as a positive step; however, we still believe that long-term systematic monitoring as well as studying the

⁴The Environment Division also includes an additional 49 Ship Escort Response Vessel System (SERVS) positions and an additional unquantified system vessel crew.

⁵SERVS implementation added another \$40 million to the Environment Division's budget.

environmental consequences of spilled oil and prioritizing research is essential to comply with right-of-way requirements.

Recommendations

To ensure that the environmental impacts of TAPS are known and that contamination from future oil spills is minimized, we recommend that the Secretary of the Interior, in cooperation with the state of Alaska and Alyeska,

- review existing studies and rank research needs so that the available resources will be used to address the highest priority environmental research needs and so that a long-term systematic monitoring strategy can be developed that assesses the pipeline's environmental impacts over time and the environmental consequences of oil spills;
- establish realistic cleanup standards on the basis of acceptable levels of contamination; and
- determine the advantages of various technologies to effectively contain, clean up, and dispose of oil spilled on water and on land, especially in arctic and subarctic conditions.

Agency Comments

In commenting on a draft of this report, Interior and the state indicated that they did not see a need for a long-term systematic monitoring strategy. We disagree. The protection of the environment was a basic tenet of the federal and state right-of-way agreements, which require that all activities associated with TAPS be conducted in a manner to avoid or minimize degradation of air, land, and water quality and provides protection to fish and wildlife and their habitats. We believe that a long-term monitoring strategy is crucial to determining what impacts TAPS has had on the environment. Although Interior indicated that the joint office is compiling a data base of existing studies, without analyzing those studies and prioritizing the need for additional studies, long-term systematic monitoring cannot occur. EPA and the state both indicated that they are studying various clean up technologies. We believe that these studies can become the basis for developing clean up standards. If properly implemented, this action should address the intent of our recommendation.

TAPS' Oversight Needs Systematic, Disciplined, and Coordinated Approach

A sound regulatory oversight program should contain clear and enforceable requirements, adequate numbers of well-trained staff, and coordination between the responsible federal and state agencies. However, until 1990, none of the elements were in place. BLM and Alaska's Department of Natural Resources, the oversight agencies with the broadest authorities for regulating TAPS, did not have adequate systems in place to carry out their oversight responsibilities. Further, until recently, none of the five regulators dedicated sufficient staff resources for monitoring pipeline activities or coordinated oversight activities to ensure that all pipeline activities and functions were monitored. This regulatory complacency resulted in unanswered questions regarding the soundness of key systems designed to ensure TAPS' operational safety, oil spill response, and ability to protect the environment.

In 1990 BLM established a joint oversight office¹ comprising federal and state agencies with statutory authority over the pipeline. As of April 1991, BLM, Transportation's Office of Pipeline Safety, Alaska's Departments of Natural Resources and Environmental Conservation, as well as the U.S. Fish and Wildlife Service and the Alaska Department of Fish and Game had assigned full-time staff to the joint office. Several other agencies, including EPA, are involved on a part-time basis. We believe that the establishment of this office is a step towards achieving a systematic, disciplined, and coordinated approach for overseeing TAPS. However, we believe that a firm commitment from EPA is needed, as well as clear leadership and a secured funding source to help ensure that this office will provide the systematic, disciplined, and coordinated approach needed to ensure TAPS' safe operation.

Elements of a Systematic, Disciplined, and Coordinated Approach

Effective regulatory oversight requires a systematic, disciplined, and coordinated approach for reviewing and recording an operator's performance to ensure compliance with various requirements. This type of approach is particularly important for the oversight of TAPS, given the sometimes overlapping responsibilities of the five regulators having jurisdiction over the pipeline's various operations. At a minimum, this approach requires the following elements:

- **Clear and enforceable requirements.** Oversight activities should be adequately structured to ensure that Alyeska's actions satisfy the stated goals or objectives contained in various laws, regulations, and requirements. Additionally, a systematic oversight approach requires specified

¹This office was established to oversee TAPS as well as the Trans-Alaska Gas System.

criteria for measuring performance against the requirements; detailed guidance or checklists for inspection and monitoring procedures—including procedures for independently assessing various systems as appropriate, the consistent documentation and reporting of findings, and the prompt notification of violations and follow up to ensure compliance.

- Adequate numbers of well-trained staff. Oversight supervisors and inspectors should have the knowledge and skills to thoroughly evaluate Alyeska's performance and clearly report findings in a timely manner.
- Coordination between the responsible federal and state agencies. The results of such coordination are that overlapping authorities are identified; information, data, and knowledge are shared; and duplication or possible inspection gaps are reduced.

TAPS' Oversight Approach Lacked Structure

Until the Exxon Valdez accident and the discovery of corrosion, the agencies were not proactive in ensuring safe pipeline operations, relying instead on Alyeska to identify and correct potential problems. Although Alyeska is responsible for conducting pipeline operations within the parameters established by federal and state requirements, the five federal and state regulatory agencies are responsible for monitoring and assessing TAPS' operations and maintenance procedures.

To assess the adequacy of the regulators' oversight, we started out with a list of the regulators' own requirements and asked them if they could tell us whether Alyeska was in compliance with all of their requirements. For the most part, they could not. BLM and Alaska's Department of Natural Resources did not have a systematic approach to carrying out their oversight responsibilities. For example, these agencies did not have criteria to determine whether regulatory requirements were being met, requirements or checklists to guide monitoring activities, reports to document observations, or procedures for follow up and enforcement actions. Rather, according to BLM officials, TAPS' monitoring and oversight activities were guided by general knowledge of the requirements and weighted by professional judgment to assess performance.

Transportation's Office of Pipeline Safety, EPA, and Alaska's Department of Environmental Conservation had a more structured approach and documented their inspections of TAPS. These systems enabled them to tell us which TAPS requirements they reviewed and which requirements were violated, required enforcement action, or required follow up.

Interior's BLM

BLM's statutory and regulatory responsibilities and authorities are the most comprehensive and broadest in scope of any of the TAPS regulators, covering pipeline operations on federal lands and the Valdez terminal, to the extent that operations there affect federal right-of-way requirements. According to the Deputy Director of BLM's Alaska State Office, however, BLM does not view itself as a regulator. Instead, BLM has relied on Alyeska to meet the specific monitoring and surveillance requirements spelled out in the federal right-of-way agreement and, for the most part, responded only when Alyeska identified a problem.

Field logs maintained by BLM showed that between 1985 and 1989, inspectors visited the pipeline frequently. However, they generally did not document which TAPS-related requirements they reviewed or whether any violations were identified, enforcement actions were taken, or follow up was needed. When a violation was identified, BLM inspectors generally did not prepare a report because, according to BLM officials, corrective action was usually taken immediately by Alyeska.

The Alaska Department of Natural Resources

Under the state right-of-way agreement, the Alaska Department of Natural Resources has oversight authority similar to BLM's for pipeline operations on state and private lands. However, the former State Pipeline Coordinator told us that the Department's oversight activities before the Exxon Valdez incident in 1989 were limited and that the Department relied on BLM and the other regulatory agencies to ensure compliance with the right-of-way requirements.

Transportation's Office of Pipeline Safety

Transportation's Office of Pipeline Safety is responsible for monitoring pipeline operations for compliance with federal safety standards and investigating the causes of pipeline spills and accidents. Since the pipeline's startup in 1977, this monitoring was performed by the Office's Western Regional Office in Lakewood, Colorado.

The Office has detailed guidance to assist the inspectors in monitoring the pipeline—including guidance for inspection and monitoring procedures. The Office also requires documentation and the reporting of findings. From 1985 to 1989 it conducted two partial pipeline inspections. These inspections in 1987 and 1988 included records reviews at Alyeska's headquarters in Anchorage and field visits to the operations control center at the Valdez terminal and the southern one-third of the pipeline. No violations were identified. The Office conducted its first complete inspection of pipeline operations in the summer of 1989,

including field visits along the pipeline and the Valdez terminal, and reviewed records to assess Alyeska's compliance with pipeline safety regulations. According to Office of Pipeline Safety officials, some probable violations were identified by their inspectors, including some relating to the cathodic protection system, and are being pursued as part of an overall investigation being conducted by the joint office.

**The Alaska Department of
Environmental
Conservation**

The Alaska Department of Environmental Conservation is responsible for enforcing environmental laws for clean air under authority delegated to it by EPA. It also assists EPA in implementing various aspects of the Clean Water Act, including reviewing and approving the terminal component of Alyeska's oil spill contingency plan.

Department officials told us that for the terminal from 1985 until 1989, they focused primarily on developing air and water permits. In addition, they inspected the terminal during scheduled visits to monitor Alyeska's compliance with the permits and documented the results. Being physically located in Valdez, they were also able to visually monitor and visit the terminal to measure day-to-day compliance. During this time, the Department issued few enforcement actions and generally did not follow up to ensure that identified problems were corrected.

EPA

EPA is primarily concerned with ensuring that TAPS' operations comply with federal clean air and water legislation. EPA has delegated parts of its responsibility for the Clean Air Act to the state of Alaska and has only one part-time staff person monitoring TAPS. From 1985 through 1989, EPA officials said its efforts were devoted primarily to issuing a water quality discharge permit at the Valdez terminal and assisting the Alaska Department of Environmental Conservation in issuing an air quality permit. EPA inspected the pipeline and terminal facilities in the summers of 1989 and 1990, respectively, for compliance with Spill, Prevention, Control, and Countermeasures Program requirements which are intended to ensure that operating practices are geared toward preventing oil spills. In addition, while EPA has authority to inspect crude oil storage tank integrity at the terminal, it has not exercised its authority in this area primarily because of unclear regulations and available resources.

Staffing Levels Limited Oversight Activities

Staffing has been limited for most of the agencies overseeing TAPS. Between 1985 and 1989, BLM had only two persons assigned as TAPS field inspectors. During this time, these inspectors made almost weekly visits to the pipeline to oversee TAPS projects and activities. However, according to these inspectors, because of the time involved in overseeing Alyeska's ongoing maintenance and repair projects, they had little time to carefully oversee whether all of the right-of-way requirements were being met. During this same period, Alaska's Department of Natural Resources assigned only a part-time inspector to TAPS oversight, relying instead on BLM inspectors to identify problems and ensure Alyeska's compliance with right-of-way requirements.

Until mid-1988, when it obtained a third inspector, Transportation's Western Regional Office of Pipeline Safety had only two inspectors to monitor pipeline safety in up to 14 states. From 1985 until 1989, Transportation conducted two partial inspections of TAPS operations.

EPA and Alaska's Department of Environmental Conservation's responsibilities include monitoring air and water quality for all sources in Alaska. Inspectors for these environmental agencies monitor TAPS as a part of their overall responsibility for the air and water quality monitoring program. However, according to officials from both of these agencies, the monitoring of TAPS has been based on the availability of staff, rather than on making sure that all requirements are being met.

Also affecting the capability of available staff to adequately monitor TAPS is the highly complex and technical nature of TAPS' systems. Understanding how these systems work and interpreting the systems' performance data provided by Alyeska requires both time and technical engineering expertise. According to inspectors and officials from BLM and Alaska's Department of Natural Resources, they did not have the time nor the expertise to thoroughly examine performance data. Between 1985 and 1989, neither of these regulators had contracted with consultants for pipeline engineering expertise to assess TAPS' systems' performance data. Unlike the other regulators, however, BLM could have hired consultants to assist them in their oversight responsibilities at no cost to the government. Under the terms of the federal right-of-way agreement, Alyeska is required to reimburse BLM for all reasonable administrative and other costs for monitoring pipeline operations, including those associated with a contractor.

Oversight Coordination Was Limited

Coordination between the federal and state regulatory agencies overseeing TAPS was limited between shortly after TAPS' construction was completed and 1989. Sharing information and knowledge is important because of the many similar requirements and overlapping responsibilities created by both federal and state requirements. However, we found that before 1989, the regulators did not systematically coordinate their actions with other agencies.

Both the technical pipeline requirements and environmental requirements that apply to TAPS' operations sometimes fall under the jurisdiction of more than one of the federal and state regulators. For example, a cathodic protection system is required under the terms of the federal and state right-of-way agreements as well as Transportation's pipeline safety regulations. Compliance is to be reviewed by BLM, Alaska's Department of Natural Resources, and Transportation's Office of Pipeline Safety. There are other technical, oil spill response, and environmental requirements with similar crossover-monitoring responsibilities.

However, we found little information being shared before 1989. For example, the Valdez terminal has never been inspected for compliance with all applicable requirements. The federal transfer of the terminal land to the state put terminal operations under Alaska's Department of Natural Resources' jurisdiction, but state inspections were not performed to enforce right-of-way requirements. BLM, although it could have enforced the federal right-of-way requirements, chose not to. Additionally, although EPA had a 1971 memorandum of understanding with Transportation outlining EPA's responsibility for ensuring the integrity of oil storage tanks, the tanks have never been inspected by EPA, and until recently, there was uncertainty by the regulators as to who had jurisdiction over tank integrity. Although some air and water quality environmental aspects of terminal operations have been scrutinized by EPA and the Alaska Department of Environmental Conservation, storage tank integrity, terminal slope stability, and other geologic hazards have received only superficial review. One of the primary purposes of the new joint office is to share information and knowledge gathered which should improve the understanding of TAPS' systems and reduce the impact of limited resources.

New Federal/State Joint Office Established to Aid Oversight

The Exxon Valdez oil spill and the discovery of corrosion along the pipeline have resulted in a flurry of regulatory activity including the formation of the joint office in 1990. The new office started with a skeletal staff from 2 agencies and has grown to encompass several agencies with 38 full-time staff as of April 1991. Each oversight agency retains its individual authority for TAPS but shares information and expertise to help improve the knowledge and coverage of TAPS' operations. This office is an important step to ensure TAPS' operational safety, Alyeska's oil spill response capabilities, and maximum mitigation of existing and future environmental degradation. In the past year, the joint office has developed a program to monitor corrosion, reviewed the oil contingency plan in detail and approved a new plan, and begun to set up a more structured and systematic monitoring program to ensure that TAPS' requirements are adequately addressed.

Participation in the joint office is mandatory for the state and voluntary for federal regulators. As of April 1991, four agencies included in our review have agreed to participate full-time: BLM, Transportation's Office of Pipeline Safety, and the Alaska Departments of Natural Resources and Environmental Conservation. EPA participates on a part-time basis. In addition, the U.S. Fish and Wildlife Service and Alaska Department of Fish and Game have joined the office. In commenting on a draft of this report, EPA indicated that it is also considering participating in the office on a full-time basis.

New Office Has Met With Some Success

To date, the joint office concept has met with some success. As of October 1990, BLM and the Alaska Department of Natural Resources had drafted a cooperative agreement regarding their respective roles, and the two agencies together with Transportation's Office of Pipeline Safety drafted an agreement, signed in November 1990, on how to proceed with investigating the cause, extent, and repair of pipeline corrosion.

The agencies are also conducting joint inspections to share knowledge of TAPS' operations and inspection techniques. They are also developing a common strategy for monitoring key design and operating requirements, such as leak detection, and have reviewed leak detection systems used on other pipelines for comparison and possible application to TAPS. They have also reviewed in detail, and approved, a new oil spill contingency plan for the pipeline.

After the Exxon Valdez incident, the staffing and expertise for four regulators—BLM, the Alaska Departments of Natural Resources and Environmental Conservation, and Transportation's Office of Pipeline Safety—have increased significantly. BLM's staffing level has increased from 7 positions in 1989 to 18 in 1991, including 2 corrosion engineers and additional field inspectors. The state also has 18 full-time positions assigned to the joint office; Transportation's Office of Pipeline Safety assigned one inspector full-time to Alaska for monitoring TAPS and other Alaska pipelines. In addition, the U.S. Fish and Wildlife Service has one full-time staff person assigned, and several other agencies have liaisons with the joint office, including EPA. The office has also hired a consultant to assist the regulators in reviewing Alyeska's corrosion program.

Improvements May Be Needed to Enhance New Office's Effectiveness

While this new sense of cooperation has increased TAPS' oversight, improvements may be needed to ensure the joint office's ability to effectively regulate TAPS. At this time there is no firm commitment from EPA, no clear leadership, and no secured funding.

Because the agencies have some overlapping monitoring responsibilities for, among other things, corrosion prevention and detection, leak detection, and oil spill contingency planning, the joint office may be more effective in the long-term if the participation of all key regulators is required—including EPA. To ensure a systematic and disciplined oversight approach, there needs to be agreement and continued coordination among the agencies concerning roles, responsibilities, and expectations. Additionally, without the full participation of EPA, comprehensive oversight at the Valdez terminal may be impaired.

Even with full participation by all agencies, there is no clear leader that will ensure that adequate oversight is occurring. For example, the joint office needs to ensure that TAPS is subject to a systematic and disciplined oversight approach. This would include ensuring that all agencies involved have programs in place to, at a minimum, document inspection results, take appropriate enforcement actions when violations are identified, and follow up to verify that corrective measures have been taken.

Funding for the joint office is also not ensured. While Alyeska is required to fund BLM oversight activities and has agreed to fund Alaska's Department of Natural Resources joint office monitoring activities, funding for the other potential participants is subject to annual budget processes. Without a secured and guaranteed funding source, the

joint office could be short-lived if resources were siphoned off for other competing priorities.

Increased TAPS oversight will require more up-front costs. However, comparing these costs with the costs associated with mitigating the environmental impacts of a major oil spill or the disruption in the delivery of 25 percent of the nation's domestic oil production may show the value of spending additional funds now to help to ensure the pipeline's safe operation. In this regard, it may be in the best interest of the nation to secure a consistent and stable funding source to ensure adequate oversight.

Conclusions

To successfully fulfill their oversight responsibilities, the five regulatory agencies can no longer be content with relying on Alyeska to police itself. The complacency that has existed in the past must be replaced with a systematic, disciplined, coordinated approach that will ensure TAPS' operational safety, oil spill response, and environmental protection. The formation of the joint office as well as recent increases in staffing levels by BLM and other agencies are encouraging signs that more oversight attention will be paid to TAPS' activities in the future. However, the same public attention that led to the establishment of the joint oversight office could also lead to its demise as national and state concerns shift to other issues. Without leadership, firm commitments from all regulatory agencies, and a secured funding source, this coordinating body may be short-lived as disagreements arise that cannot be resolved and resources are siphoned off for other competing priorities.

We believe the joint office, with central leadership, may help ensure that specific actions are taken to achieve an appropriate level of oversight. We also believe that while the federal government has comprehensive and broad oversight responsibilities for the pipeline and the terminal at Valdez, participation by the state of Alaska is crucial to providing comprehensive coverage. Finally, we believe that achieving effective oversight requires a consistent source of funding, not subject to changing agency priorities. One mechanism to provide the funds would be to require Alyeska to reimburse all reasonable oversight costs similar to what it is now required to do for BLM. This is important given that Alaska's energy sources are likely to be a critical component of the nation's long-term energy strategy. For example, TAPS is the most likely means of transport if the Arctic National Wildlife Refuge is developed. In addition, the pipeline corridor will be used in the construction of a natural gas pipeline from Prudhoe Bay to Valdez.

Recommendations

We recommend that the Secretaries of Interior and Transportation and the Administrator of EPA, in coordination with the state of Alaska, ensure that the new joint office provides systematic, disciplined, and coordinated oversight of TAPS. At a minimum, this requires

- central leadership;
- adequate funding;
- firm commitments to participate from the primary regulators of TAPS; and
- clear and enforceable requirements, adequate numbers of well-trained staff, and coordination among the responsible federal and state agencies.

Matter for Congressional Consideration

To help ensure that sufficient funds are available to support improved oversight, the Congress may wish to consider requiring Alyeska to fully reimburse the joint office for all reasonable oversight costs as it is now required to do for BLM.

Agency Comments

In commenting on a draft of this report, most of the regulators believed that we were not giving the joint office a chance to work. It was not our intent to imply that the joint office cannot work. However, we do have some concerns about the office's lack of central leadership and funding. We believe that central leadership would help to ensure that the varied agencies, some with overlapping responsibilities, are performing their respective roles; a secured source of funds would insulate the office from possible funding reductions because of competing priorities; and EPA participation is important to comprehensive oversight. EPA, which is considering joining the joint office on a full-time basis, agreed with our concerns regarding the lack of central leadership and a secured funding source in the joint office.

Update on Air Quality Control Permit

In December 1988, we issued a report that addressed whether operational and physical changes affecting control equipment at TAPS' Valdez terminal and the pump stations required Alyeska to file for a new air quality control permit.¹ Under the 1977 amendments to the Clean Air Act, if a major modification in equipment or operation increases pollution, the company is required to apply for a new air quality control permit—called a Prevention of Significant Deterioration (PSD) permit and must make changes to facility operations by adopting the best available control technology to reduce pollution.

In our 1988 report, we found that while the state identified several changes in operation, including changes in the incinerators designed to burn waste gases, emission data were not available to prove that these changes constituted major modifications, which could cause significant emissions increases. The report noted that EPA, the Alaska Department of Environmental Conservation, and Alyeska were actively discussing the need for Alyeska to amend its existing operating permit and apply for a PSD permit. EPA, with the state's concurrence, requested that Alyeska provide additional information on operational changes and pipeline emission levels.

In June 1990, after a 2-year study of Alyeska data, the Alaska Department of Environmental Conservation, in coordination with EPA, concluded that it now had the evidence to prove that changes to TAPS' operations constituted modifications that required a PSD permit. The four physical and operational changes at the terminal and at the pump stations resulting in emissions greater than the limits allowed under federal and state laws cited by the regulators included

- an increase in the maximum fuel consumption of each of the main gas turbines located at pump station Nos. 1 through 4, 6 through 10, and 12 due to a modification to the turbines (called "rim cooling"), resulting in an increase in oxides of nitrogen emissions greater than 40-tons-per-year;
- an increase in the maximum sulfur content in the fuel oil used in the main gas turbines in pump station Nos. 6 through 10 and 12, resulting in an increase in sulphur dioxide emissions greater than 40-tons-per-year;
- an increase in the release of volatile organic compounds from the crude oil storage tank vents at the Valdez terminal greater than 40-tons-per-year; and

¹Air Pollution: Status of Dispute Over Alaska Oil Pipeline Air Quality Controls (GAO/RCED-89-37, Dec. 6, 1988).

- an increase in the maximum rated capacity of the waste incinerators located at the terminal, resulting in emissions of oxides of nitrogen and sulfur greater than 40-tons-per-year.

Both EPA and the Alaska Department of Environmental Conservation notified Alyeska that the above changes violated federal and state laws requiring that PSD permits be obtained before any changes are made to operations that increase levels of emissions. On June 19, 1990, EPA issued a notice of violation which stated that Alyeska must come into compliance with the Clean Air Act within 30 days or civil action could be taken against Alyeska.

Alyeska officials told us that in response to the notice of violation, they made several changes to their operations and facilities, including removing some equipment modifications and returning to operating conditions similar to those approved by the Alaska Department of Environmental Conservation in 1975. Despite these steps, the Alaska Department of Environmental Conservation believed that some air quality issues, such as the venting of volatile organic compounds from its storage tanks at the Valdez terminal, remained unresolved. However, the agency issued Alyeska a 6-month temporary permit on July 19, 1990. The new permit includes amendments incorporating limits to operating conditions and adding more stringent emissions levels. The permit also requires Alyeska to monitor air quality at the terminal in order to provide data necessary to determine the levels of emissions and changes in air quality. EPA notified Alyeska on July 25, 1990, that, on the basis of corrective actions taken and the conditions contained in Alaska Department of Environmental Conservation's temporary permit, TAPS was operating in compliance with respect to the items cited in the June 1990 notice of violation.

To address issues which remained unresolved, the Department and Alyeska signed a compliance order in September 1990, in which they agreed to ensure full compliance with federal and state air quality permit requirements and to resolve the remaining air quality disputes. Among other things, the order requires Alyeska to submit a "best available control technology analysis" of tank venting, including a proposed implementation schedule. The order also includes a plan to create an advisory group comprising Alyeska and state representatives. The group will evaluate TAPS air quality issues and make recommendations.

Alyeska recently applied for a PSD permit to allow the reinstallation of rim cooling at two pump stations and intends to apply for permits to

allow the use of higher sulfur fuel oils at six pump stations now using a more expensive low-sulfur fuel.

Tanker Emissions

In addition to concerns related to increased pollution resulting from physical and operational changes to the pump stations and terminal, the state is concerned about increased hydrocarbon vapor emissions resulting from loading crude oil and other petroleum products into tanker ships. These vapors are naturally present in petroleum products and are generally forced out of cargo compartments into the surrounding atmosphere during loading operations.

Between September 1988 and September 1989, the ARCO California was tested at Valdez for hydrocarbon vapor emissions including volatile organic compounds such as benzene and toluene. Using EPA models, the vapor emissions levels measured were about twice the emission levels previously estimated. According to an Alaska Department of Environmental Conservation official, as of January 1991, the estimated total for all loadings was about 45,000 to 50,000-tons-per-year. Concerned about the health effects of these emissions, the state has proposed regulations that would limit the amount of emissions allowed into the environment. According to a department official, the proposed regulations establish standards of operation. In order to meet the standards, Alyeska would likely have to make changes in equipment, such as designing and constructing a system for recovering and incinerating those vapors caused by tanker loading. The proposed regulations are expected to be approved and become effective by the fall of 1991. It is uncertain at this time exactly how these regulations will affect the TAPS terminal. In addition, Alyeska is monitoring air quality in Valdez to project possible health risks.

Our 1988 report on national issues related to tanker emission controls² stated that several state and local air pollution control districts were considering vessel emission controls, but that there were no national standards. In November 1990, the Congress passed an amendment to the Clean Air Act requiring EPA to develop standards applicable to tanker emissions within 2 years. Also, several state and local districts have marine vessel recovery regulations in place, including the state of New Jersey and the Santa Barbara, California, Air Pollution Control District.

²Air Pollution: Issues Inhibiting Marine Vessel Emission Controls Are Still Unresolved (GAO/RCED-89-12, Dec. 9, 1988).

There are still no national controls or standards, in part because of questions about safety, cost, and the effects on interstate commerce. Although some of these questions remain unanswered, the U.S. Coast Guard recently promulgated safety standards for such vapor control systems.

Update on Ballast Water Treatment Permit

Alyeska operates a ballast water treatment facility at its terminal in Valdez to treat ballast water before it is discharged into surface waters. The Clean Water Act requires facilities like Alyeska's to obtain an NPDES permit from EPA regulating the types and amounts of pollutants that can be discharged.

EPA, in coordination with Alaska's Department of Environmental Conservation, first issued Alyeska's ballast water treatment permit in 1974, and then reissued it in 1980. The permit expired in 1983, and was not reissued until 1989. In the interim, the facility operated under a regulatory extension of the 1980 permit. According to EPA officials, a permit was not reissued until 1989 because during the interim period, several studies of alternative means to improve waste water treatment were being conducted by Alyeska and EPA.

In May 1990, we reported that the 1989 reissued permit had more stringent limits for discharged treated ballast water as well as new reporting and testing requirements.¹ Additionally, environmental monitoring requirements were strengthened. Our report noted that several factors influenced the permit changes, including (1) Alyeska's operating data, which indicated that lower effluent limits were achievable; (2) EPA's use of more stringent technology standards for the type of pollutants being discharged; (3) the state's decision to require stricter permit limits; and (4) public allegations that materials other than oily water were being discharged into the ballast water treatment facility.

Our 1990 report noted that several requirements under the reissued permit were being deferred or changed because of negotiations resulting from Alyeska's appeals including (1) the sampling location for environmental monitoring, (2) the timing of certain studies, and (3) the development of best management practices. In November 1990, EPA, the state, and Alyeska reached a settlement on the specifics of each issue, which is reflected in a modified permit.

Our 1990 report also stated that according to EPA officials, Alyeska will not be able to comply with all the requirements of the reissued permit until the expanded treatment facility is constructed and/or requirements are deferred or changed. The state approved Alyeska's ballast water treatment facility construction plan, and construction began in the summer of 1990. It is currently scheduled to be completed in late

¹Water Pollution: Alyeska's Efforts to Comply With Reissued Ballast Water Treatment Permit (GAO/RCED-90-124, May 8, 1990).

1991. According to EPA and Alaska Department of Environmental Conservation officials, the new facility will help meet the new effluent requirements.

In addition to the requirements contained in the NPDES permit, Alyeska must meet new requirements contained in the Resource Conservation and Recovery Act (RCRA) toxicity characteristic regulations which went into effect in September 1990. RCRA regulates facilities that generate, treat, store, or dispose of hazardous waste. According to an Alaska Department of Environmental Conservation official, because Alyeska disposes of benzene in impound basins, the terminal is now classified as a hazardous waste treatment facility under RCRA. As such, Alyeska must comply with interim status standards for hazardous waste treatment facilities under RCRA regulations. These regulatory requirements are designed to minimize the chances that the hazardous waste will migrate into surrounding waters or soils. According to Alyeska officials, while the ballast water treatment facility construction plan calls for building tanks to replace the impoundment basins, the tanks will not be operational until 1991. EPA officials stated that Alyeska will have to meet additional RCRA requirements to close out the basins as they are phased out and replaced by tanks.

Comments From the Department of the Interior

Note: GAO comments supplementing those in the report text appear in appendix VII.



United States Department of the Interior

OFFICE OF THE SECRETARY
WASHINGTON, D.C. 20240

APR 30 1991

Mr. James Duffus, III
Director, Natural Resource Management Issues
Resources, Community, and Economic
Development Division
General Accounting Office
Washington, D.C. 20548

Dear Mr. Duffus:

Thank you for the opportunity to review the General Accounting Offices' (GAO) draft report, Trans-Alaska Pipeline: Regulators Have Not Ensured That Government Requirements Are Being Met GAO/RCED-91-89. We have reviewed the report. Our comments are provided to assist you and the readers to understand the administration of the pipeline, reflect our concerns, and provide suggestions for you to consider in completing your report.

The Trans-Alaska Pipeline System (TAPS) is a viable functioning system that provides for the transportation of nearly 25 per cent of the Nation's oil from Prudhoe Bay to the Port of Valdez, Alaska. More than 8 billion barrels of oil have flowed through the pipeline in its 14 years of operation. With over 9 million barrels of oil in the pipeline, at any point in time, the system must work flawlessly with the utmost concern for safety and security. The system is seen as equal to any of the greatest engineering achievements of modern times. The design, construction and operation of this system is second to none. As the system ages, it, like all other mechanical creations of man, will wear so it must be continuously monitored and maintained. This has been an ongoing process over the entire 14 years of operation and will continue for the life of the pipeline. The administrative oversight structure has changed. The Department of Interior and the State of Alaska and other Federal agencies have established a joint pipeline monitoring office (JPMO). In May 1990 an agreement was signed, and this office is staffed and equipped. Other key agencies such as the U.S. Fish and Wildlife Service and the Department of Transportation, have placed personnel in the JPMO. Specific expertise not available on the staff is brought in as required. The "system" is working because all involved in oversight of the pipeline are located together in one office and working as a unified team.

We are concerned that the GAO report on the Trans-Alaska Pipeline System, the environment through which it passes and the regulatory framework under which it functions be as clearly written as possible. Our understanding is that the report will review the

See comment 1.

**Appendix III
Comments From the Department of
the Interior**

years 1985 - 1989 and clearly state the changes now taking place through the establishment of the JPMO. Issues brought out in the report are already being addressed through the JPMO. Our firm conviction is that a joint approach to the management of the pipeline system is the most sensible and cost effective way to move on into the future.

See comment 2.

We believe the draft report approaches and addresses issues through simplistic assessments and incomplete information. The reader may be misled by the limited information that casts shadows of doubt on the oversight of the pipeline and the efforts underway to establish a working relationship involving all agencies. The report also fails to sufficiently consider the complex interactions of statutory requirements, pipeline operation, and unique environmental conditions.

We agree with your conclusion and recommendation for the establishment of a lead entity through the formation of a commission if the JPMO does not work. At present time, the joint office is structured under a memorandum of understanding between the two agencies (Bureau of Land Management and the Alaska Department of Natural Resources) that are responsible for the administration of the right-of-way grants. Memoranda of understanding with other agencies such as the Corps of Engineers, and others as needed, have been completed for special projects. Additional staffing of personnel from the U.S. Fish & Wildlife Service and the Federal Department of Transportation are a part of the JPMO.

See comment 3.

The GAO report should recognize the historical willingness of Alyeska to work in harmony with the Department of the Interior. This cooperative working environment has not created the need for an adversary regulatory process to be put into place. The report would have the reader believe that it is pure luck that a catastrophic event has not occurred. This is simply not true. The fact that the system has functioned smoothly for 14 years and that there have been no significant adverse events is a direct result of the Department's and the pipeline company's willingness to work together to see that the environment and the public safety are protected.

Following are our responses to recommendations contained in the draft GAO report:

GAO recommends that the Secretary of the Interior, the Secretary of Transportation, the Administrator of EPA, in cooperation with the State of Alaska (where appropriate);

- reassess the adequacy of Alyeska's corrosion prevention and detection efforts, including (1) the cathodic protection system intended to draw corrosive agents away from the pipeline and (2) plans to better detect and correct internal and external corrosion problems along the pipeline and at the Valdez terminal;

Appendix III
Comments From the Department of
the Interior

See comment 4.

Response: The Bureau of Land Management (BLM), Alaska Department of Natural Resources (DNR) and the Department of Transportation (DOT) are continuing to assess the adequacy of Alyeska's corrosion prevention and detection procedures. This assessment, initiated in 1989, is reviewing Alyeska's methods of detection, repair procedures, the past history, current situation, and future long range solutions to the corrosion problem.

- require Alyeska to test its leak detecting system at various levels of pipeline operations to determine what levels of leakage will trigger an alarm and decide if these sensitivity levels meet operating requirements;

See comment 5.

Response: BLM and DNR recognized the need to test the leak detecting system in 1989, and made it an integral part of Alyeska's oil spill response system. A leak detecting system test is scheduled for July, 1991.

- monitor and evaluate Alyeska's efforts to assess and mitigate geologic hazards along the pipeline and at the terminal, including those intended to (1) stabilize the rock slopes at the terminal and along mountainous sections of the pipeline, (2) safeguard permafrost, and (3) guard against erosion; and

See comment 6.

Response: Monitoring and evaluating Alyeska's efforts to assess and mitigate geologic hazards along the pipeline has always been accomplished. We suggest the recommendation be reworded to include the words "Continue to" monitor and evaluate... BLM is currently implementing a system to improve documentation of the monitoring and evaluation program by use of a computerized tracking system.

- develop regulations to ensure federal or state oversight of the integrity of the crude oil storage tanks at the Valdez terminal.

See comment 7.

Response: Alyeska operates under three separate oil spill contingency plans. One plan is for the terminal, one plan is for the harbor, and one plan is for the pipeline. Oversight authority and responsibility of the terminal and harbor traffic reside with the state of Alaska, Department of Environmental Conservation, and the EPA oil pollution prevention regulations at 40 CFR Part 112. The BLM has oversight responsibility for the pipeline oil spill contingency plan in conjunction with the state of Alaska, DNR.

To ensure that resources and equipment are adequate to respond to a large-scale leak and can be promptly mobilized and deployed, we recommend that the Secretary of the Interior, in cooperation with the State of Alaska,

See comment 5.

- review all components of Alyeska's oil spill contingency plan and require that deficiencies identified are formally noted and corrected before the updated plan is approved;

Response: The BLM and the DNR have recently completed a two year intensive and exhaustive review of Alyeska's oil spill contingency plan for the pipeline. The updated plan was reviewed by all state and Federal regulatory agencies and was also made available to the public through the public review process. This updated plan was approved in early April, 1991.

See comment 8.

- actively participate and observe Alyeska's oil spill drills and training exercises, and require that Alyeska address deficiencies identified during these drills; and

Response: Active participation in the oil spill drills and training exercises by the regulatory agencies has been done since the pipeline began operation. The new incident command system requires an active role by the BLM and the state of Alaska. This will ensure a greater state and Federal role in all aspects of these drills and exercise programs described in the oil spill response plan.

See comment 9.

- require Alyeska to conduct a companywide, full-scale drill that tests the leadership, coordination, communication, and equipment and personnel mobilization required to locate, contain, and clean up a large-scale oil leak.

Response: Drills designed to test the leadership, coordination, and communication are being established in conjunction with the approval of the updated oil spill response plan. Drills designed to test limited personnel and equipment have been and will continue to be conducted. Since all the personnel and equipment required to contain and clean up an oil spill are on site 24 hours a day 365 days a year, it is not necessary to conduct a full-scale drill mobilizing all personnel and equipment. The people are trained specifically for containing and cleaning up an oil spill along the length of the pipeline, and the equipment is on site and diligently maintained. Any delay in the response would occur because of a breakdown in coordination and communication. As mentioned above, drills are being established to test and improve these factors.

To ensure that the environmental impacts of TAPS are known and that contamination from future oil spills is minimized, we recommend that the Secretary of the Interior, in cooperation with the State of Alaska and Alyeska,

- develop a long-term systematic monitoring strategy that includes gathering the necessary baseline information to determine both the pipeline's environmental impacts over time as well as the environmental consequences of oil spills;

Appendix III
Comments From the Department of
the Interior

See comment 10.

Response: Adequate baseline information already exists, and more is being developed daily. The JPMO's library is bringing all of this information to one location. The library is staffed with a professional librarian who is organizing and cataloging all available information.

- establish realistic cleanup standards on the basis of acceptable levels of contamination;

See comment 11.

Response: A single cleanup standard cannot be established along the length of the pipeline due to the changes in topography, climate, and sensitivity of the local environment. BLM has been monitoring all spill sites and gathering data from the time of spill until today. BLM and the state of Alaska are working with Alyeska to catalog and analyze this information. The standards we use consider the size of the spill as well as those topics listed above. Cleanup standards dictate that cleanup procedures will continue as long as the environmental impacts of the procedures have not exceeded the environmental impacts of the remaining spilled oil.

- determine the advantages of various technologies to effectively contain, clean up, and dispose of oil spilled on water and on land, especially in arctic and subarctic conditions; and

See comment 12.

Response: Disposal of hazardous materials is closely regulated by statutes such as the Clean Water Act, RCRA, CERCLA, etc.. A committee, consisting of BLM, the State of Alaska, and Alyeska, has been established and is evaluating and studying new advances in oil spill cleanup technology.

- rank research needs so that the available resources will be used to address the highest priority environmental research needs.

See comment 10.

Response: The BLM has not identified the need for any additional research along the pipeline at this time. There are independent studies being conducted by universities in the vicinity of the pipeline on arctic issues. Adequate baseline information about the environmental impacts from the pipeline already exists, and more is being developed daily. The JPMO's library is bringing all of this information to one location. The library is staffed with a professional librarian who is organizing and cataloging all available information. This will greatly improve accessibility to all existing information. Alyeska personnel are reviewing and analyzing oil spill data related to all upland oil spills.

Appendix III
Comments From the Department of
the Interior

We appreciate the continued coordination with your staff during the development of this report and the opportunity to review the draft and provide you with further constructive comments. Of particular concern are statements and perceptions expressed in the report that may be misinterpreted by the reader. We request you consider the comments and amend the report accordingly.

Specific comments are attached for your consideration.

Please let us know if we may be of further assistance.

Sincerely

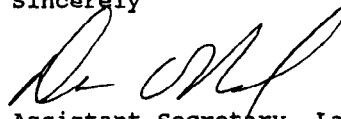

Assistant Secretary, Land and
Minerals Management

Attachment

Comments From the Department of Transportation

Note: GAO comments supplementing those in the report text appear in appendix VII.



**U.S. Department of
Transportation**

Assistant Secretary
for Administration

400 Seventh St. S.W.
Washington, D.C. 20590

May 2, 1991

Mr. Kenneth M. Mead
Director, Transportation Issues
U.S. General Accounting Office
Washington, D.C. 20548

Dear Mr. Mead:

Enclosed are two copies of the Department of Transportation's comments concerning the U.S. General Accounting Office draft report entitled "Trans Alaska Pipeline: Regulators Have Not Ensured That Government Requirements Are Being Met."

Thank you for the opportunity to review this report. If you have any questions concerning our reply, please call Martin Gertel on 366-5145.

Sincerely,

Paul Wein
for Jon H. Seymour

Enclosures

I. **TITLE: TRANS ALASKA PIPELINE: Regulators Have Not Ensured That Government Requirements Are Being Met**

II. **SUMMARY OF GAO FINDINGS AND RECOMMENDATIONS**

The General Accounting Office (GAO) reviewed the adequacy of the regulatory oversight of the Trans-Alaska Pipeline System (TAPS) during the period from 1985 to 1989, by the five principal agencies with oversight responsibilities. The review focused on operational safety, oil spill response, and environmental protection. GAO found that there has been little structured oversight of TAPS. GAO found that sufficient staff resources had not been dedicated to the monitoring of pipeline activities and that coordination among the agencies had been limited.

GAO noted that there have been recent increases in staffing and that a Federal/state joint monitoring office (Task Force) has been formed. However, GAO points to weaknesses in the Task Force approach and recommends that a single lead entity with a consistent source of funding would better ensure that a disciplined and coordinated approach to TAPS oversight is achieved. GAO argues that a lead entity would provide for better allocation of resources and better sharing of information among the regulatory agencies.

In evaluating whether the regulatory agencies were effective in assessing the operational safety of TAPS, GAO focused on leak detection, corrosion prevention and detection, geologic hazards, and storage tank integrity.

- o GAO found that the monitoring and evaluating of TAPS operations have been inadequate.
- o GAO found that the agencies have been complacent in their regulatory responsibilities and have relied on Alyeska to police itself.
- o In particular, GAO found that although the agencies were aware of difficulties in Alyeska's corrosion prevention and detection system, until 1989 they did not independently evaluate the corrosion detection data or increase monitoring. Nor did the agencies require that Alyeska's leak detection system be tested.
- o GAO also found that attention has not been paid to Alyeska's efforts in addressing geological hazards and integrity of the crude oil storage tanks at the Valdez terminal.

GAO recommends that the agencies reassess the adequacy of Alyeska's corrosion prevention and detection efforts, require leak detection testing, monitor and evaluate efforts to assess and mitigate geologic hazards along the pipeline and at the terminal, and develop regulations to ensure oversight of the integrity of the terminal storage tanks.

III. SUMMARY OF THE DEPARTMENT'S POSITION

TAPS was constructed using technology that at the time was on the cutting edge. The Department's Research and Special Programs Administration (RSPA) recommended to the Department of the Interior (DOI) that Alyeska use periodic pig surveys as part of Alyeska's Corrosion Control Plan, due to concerns about the pipeline's coating system and unique environment. Pigs were run in 1978, and from 1981 to 1987 but corrosion was not detected. It was not until 1988 when a third type of corrosion control pig was run that corrosion was detected. RSPA's recommendation was appropriate since pigging detected corrosion before any pipeline spillage occurred.

The Department agrees that oversight of TAPS was limited, primarily due to limited resources. From 1983 until 1988, RSPA's Office of Pipeline Safety Western Region, which performed the TAPS monitoring, had two inspectors responsible for monitoring pipeline safety in 12 states. However, beginning in the spring of 1990, one person from the Western Region has been dedicated full-time to Alaska to inspect the operation of all pipelines in the state, including Alyeska.

In addition, due to the oversight given during construction, the technology used, and the pipeline's corrosion history, there was little perceived risk which would have warranted increased monitoring. As GAO noted, RSPA has detailed guidance to assist the inspectors in monitoring the pipeline. During the five-year period GAO reviewed, RSPA conducted limited inspections, documented those inspections, and identified deficiencies with Alyeska's cathodic protection system. Furthermore, after corrosion was discovered in 1988, RSPA identified the pipeline as requiring higher priority and began conducting annual inspections.

RSPA has monitored Alyeska's efforts to address geological hazards. Since Alyeska's experience with two settlement failures in 1979, Alyeska has conducted geometry pig surveys on a regular basis, has identified several areas where settlement has occurred, and has taken corrective action. RSPA assessed the condition of the repairs for these settlement failures and found them in compliance with the regulations. In 1984 and 1989, RSPA monitored Alyeska's pipeline stability program to mitigate pipe settlement and will continue to do so.

Although RSPA's regulations do not require the installation of a leak detection system, they do require that pipeline operators monitor their systems for abnormal operating conditions and correct such conditions when identified. Like many other operators, Alyeska has chosen to meet this requirement with a real-time computer-based leak detection system. The Department agrees that Alyeska should be required to test its leak detection system.

See comment 13.

Appendix IV
Comments From the Department
of Transportation

See comment 14.

The Department agrees that, historically, there was no coordinated approach to TAPS oversight. In 1990, the Task Force was formed to achieve a disciplined and coordinated approach to reviewing and investigating the operational safety of TAPS. This Task Force will allocate the joint resources of its participating members so that the objectives of the Memorandum of Agreement that the parties executed can be met. The Task Force has resulted in better information exchange. The Department does not agree that it is necessary to designate a lead agency, by statute. The Department believes that the current Task Force approach can work given the continued commitment, including the provision of sufficient resources, by the participating members.

IV. THE DEPARTMENT'S POSITIONS: STATEMENT BY STATEMENT

POSITION STATEMENT: TAPS Oversight Needs Systematic, Disciplined, and Coordinated Approach.

GAO Finding:

- o The five principal regulatory agencies do not have a systematic, disciplined, and coordinated approach to regulate TAPS. Instead, these agencies have relied on Alyeska to police itself. As a result, these agencies do not know if Alyeska's operating and maintenance procedures meet the pipeline's special engineering design and operating requirements.
- o There are impediments to a systematic, disciplined, and coordinated approach for overseeing TAPS. For example, only the Bureau of Land Management (BLM), Transportation's Office of Pipeline Safety, and Alaska's Department of Natural Resources have agreed to participate in this voluntary effort--the Environmental Protection Agency (EPA) and the Alaska Department of Environmental Conservation have not joined citing a lack of resources.
- o In addition, there is no secure funding source and no central leadership. Without these essential elements, this coordinating body may be short-lived as disagreements arise that cannot be resolved and resources are siphoned off for other competing priorities. GAO believes that a lead entity with a consistent and stable funding source is needed to help ensure adequate oversight and resources (pp. 3, 4, 5, 7, 32, 33, 70).

The Department's Response:

Although the agencies have no authority over each other, RSPA has long recognized the need to coordinate monitoring of inspection activities, and during the last year has taken significant actions with respect to monitoring Alyeska's operations.

See comment 1.

Appendix IV
Comments From the Department
of Transportation

- o Since the start-up of TAPS operations, RSPA has communicated with BLM and has shared information.
- o RSPA has participated with other regulators in monitoring pipeline stability in permafrost areas.
- o Since the pipeline's construction, the agencies have monitored pipeline corrosion frequently through pigging.
- o RSPA has conducted several comprehensive Operation and Maintenance (O&M) inspections pursuant to 49 CFR Part 195 and, in 1987, began coordinating such inspections with BLM. These efforts are continuing.
- o In 1990, RSPA, in conjunction with the Task Force, denied a request by Alyeska to increase the pressure at Pump Station No. 4 until the Atigun replacement is completed.
- o In 1990, RSPA and BLM investigated allegations by a former Alyeska contractor employee of improper ultrasonic test confirmation of pig data. The investigation revealed that, although contractor oversight was lax, the actual testing had been done properly.
- o In June 1990, RSPA assigned a full-time inspector to Anchorage to represent the agency. In November 1990, RSPA, BLM, and the State of Alaska adopted a formal Memorandum of Agreement to set goals and priorities. The parties occupy joint office space, share information and advise each other of activities being conducted. RSPA has accepted the role of coordinator and the group has identified roles for specific investigations. The review process has commenced to assure that Federal and state safety requirements and all the original permit requirements are being fulfilled.
- o Finally, the Task Force has been enhanced through the recent membership of the Alaska Department of Environmental Conservation, an addition that will increase the ability of the Task Force to address environmental concerns.
- o The Department does not agree that the joint office Task Force cannot provide the systematic, disciplined, and coordinated approach we agree is necessary. We do agree that sufficient resources are necessary to achieve this goal, and that each agency needs to seek those resources and the Congress needs to respond accordingly. Given the excellent cooperative spirit shown to date, there is every reason to expect that the current approach of shared leadership will continue to prove effective.

See comment 14.

POSITION STATEMENT: TAPS Has Not Been Given Sufficient Corrosion Oversight.

GAO Finding:

- o Regulators knew that the pipeline coating and tape, applied for corrosion protection, were damaged during pipeline construction. They did not monitor damaged coating and tape, nor did they require Alyeska to do so (p. 5).
- o Regulators were aware of inadequacies in Alyeska's corrosion prevention and detection system for many years. Regulators did not independently evaluate the system or the corrosion detection data, nor did they require Alyeska to take alternative measures (as, increase its monitoring for corrosion) (pp. 27, 28, 32). Furthermore, regulators did not monitor areas identified by noncompliance citations to determine whether these areas were experiencing corrosion, nor did they require Alyeska to provide special attention to these areas (p. 32).
- o None of the regulators examined the adequacy of TAPS' corrosion prevention and detection system until after Alyeska reported corrosion along the pipeline in 1989. They instead relied on Alyeska's assurances that corrosion was not occurring (pp. 5, 28).

The Department's Response:

RSPA views Alyeska's corrosion prevention and detection system as consisting of four parts:

- (1) Anode ribbon cathodic protection system;
 - (2) Coating and tape overwrap;
 - (3) Monitoring of pipe-to-soil potential; and,
 - (4) Periodic instrumented pig surveys.
- o RSPA recommended that DOI require periodic instrumented pig surveys as part of Alyeska's Corrosion Control Plan. RSPA does not require other operators to pig on a regular basis. RSPA recommended pigging due to concerns about the pipeline's coating system, as well as the pipeline's unique environment. This recommendation proved appropriate as pigging discovered corrosion before any pipeline spillage occurred.

The first instrumented pig survey was run on the Alyeska pipeline in 1978 with one type of corrosion pig, quarterly from 1981 through 1983 with another type, and semiannually since 1983. There was no hard evidence that corrosion existed in the pipeline until a third type of corrosion control pig, the IPEL magnetic pig, was run in 1988.

Appendix IV
Comments From the Department
of Transportation

After corrosion was found, Alyeska promptly initiated an investigation to determine cause, extent, and proper remedial actions. Alyeska and NKK began their collaboration to develop the ultrasonic pig presently used. The NKK pig was run in 1989, 1990, and is scheduled to be run in 1991. The NKK pig is the result of Alyeska's desire to obtain the optimal measurement device. Because the NKK pig is state-of-the-art and tailored specifically to the Alyeska pipeline, it is not typical of pigs used on other pipelines.

RSPA's oversight of the Alyeska pipeline, prior to the discovery of corrosion, was adequate given Alyeska's operating history.

See comment 15.

- o More oversight was given to the Alyeska pipeline during its construction than to any other pipeline. It has never had a corrosion leak. RSPA has taken only one enforcement action against Alyeska (a 1984 Warning Letter for inadequate corrosion protection in an area other than Atigun Pass). Furthermore, in 1984, Alyeska contracted with Battelle Labs to conduct an extensive field corrosion survey and analysis to assess the condition of the pipeline. After inspecting the line in 33 places, Battelle determined that the pipe was in excellent condition.

Due to the pig data, the Battelle report, the absence of corrosion-related accidents, the newness of the pipeline, and the discovery of no violations during the 1984 RSPA inspection, RSPA had no reason to believe that the pipeline presented an exceptional risk to public safety. Until corrosion was discovered in 1988, there was no reason to believe the interval between pipeline inspections (which were conducted in 1984 and 1987) was too great. Inspections have been scheduled on an annual basis since corrosion was discovered.

- o In December 1990, RSPA, following discussion with the Task Force, denied Alyeska's request for an operating pressure increase in the Atigun Pass area (the area of greatest corrosion). This denial was based on RSPA's independent evaluation of wall thickness data (ultrasonic and field data from dig sites) that RSPA had obtained from Alyeska.

GAO Recommendation:

- o GAO recommends that regulators reassess the adequacy of Alyeska's corrosion prevention and detection efforts, including: (1) the cathodic protection system intended to draw corrosive agents away from the pipeline, and (2) plans to better detect and correct internal and external corrosion problems along the pipeline at the Valdez terminal.

The Department's Response:

The Department agrees with GAO's recommendation that there should be a reassessment of Alyeska's corrosion prevention and detection system. RSPA, through its primary pipeline safety oversight role, and in conjunction with its Task Force partners, has, since 1989, been conducting an assessment of the Alyeska corrosion control program. The Task Force has identified external corrosion found on the TAPS mainline as its primary focus. The Task Force's corrosion-related priorities include:

- o cathodic protection/corrosion throughout the pipeline system;
- o design review of the Atigun River replacement segment scheduled for construction in 1991;
- o adequacy of sleeving as a repair method for corrosion repair and buckling reinforcement; and,
- o review and analysis of 1989 and 1990 internal inspection data.

At the conclusion of the corrosion control assessment phase of the current Task Force investigation, the Task Force will issue a report to Alyeska with findings and recommendations for effective corrosion control. Should Alyeska fail to respond adequately to the recommendations, RSPA will then consider whether to begin enforcement action.

POSITION STATEMENT: Regulators Have Not Overseen Alyeska's Assessment of Geologic Hazards.

GAO Finding:

- o Regulators have not assessed Alyeska's performance of the surveillance and maintenance programs in the area of geologic hazards to assure that the designs and construction procedures used by Alyeska were correct. These geologic hazards include rock slides, avalanches, and landslides, permafrost thaw, and river erosion (pp. 41-43).

The Department's Response:

It is not accurate to state that regulators have not assessed Alyeska's program for considering and addressing geologic hazards. RSPA has monitored Alyeska's pipeline stability program, including Alyeska's remedial measures to correct pipe settlement of the buried portion of the pipeline due to permafrost thawing.

At the time of construction, efforts were taken to bury the pipeline in areas that testing indicated were not susceptible to thawing. However, some potential exists for thawing, due to the presence of permafrost undetected when the ditch was excavated.

See comment 13.

Appendix IV
Comments From the Department
of Transportation

Loss of support, for the buried pipe, from thawing, could result in buckling of the pipe and ultimately lead to a fracture in the pipe resulting in a catastrophic pipeline spill.

- o Alyeska did experience two settlement failures in June 1979. Fortunately, the spills that resulted were not large (300 and 1,500 barrels). In 1984, RSPA monitored the repair of each of these failures and determined that the repairs were effective.
- o Alyeska has conducted geometry pig surveys on a regular basis since these failures occurred and has identified a number of areas where there has been settlement. RSPA has monitored this activity, and corrective action was taken before other failures of the pipe occurred.
- o In 1984 and again in 1989, RSPA assessed the pipeline stability program to monitor pipe settlement of the buried part of the pipeline. This program consists of the installation of settlement rods on the top of the buried pipe extending above the ground surface, periodic engineering surveys to determine any elevation change to the rods, and analyzing the results of geometric pig surveys. Based on this assessment, RSPA has determined that Alyeska's pipeline stability program is effective in preventing significant instability.

GAO Recommendation:

- o The Federal Government monitor and evaluate Alyeska's efforts to assess and mitigate geologic hazards along the pipeline and at the terminal, including those intended to: (1) stabilize the rock slopes at the terminal and along mountainous sections of the pipeline, (2) safeguard permafrost, and (3) guard against erosion (p.48).

The Department's Response:

The Department agrees that RSPA and its Task Force partners should continue to assess Alyeska's program for addressing geologic hazards. RSPA will continue to assure that the structural integrity of the pipeline is not reduced because of settlement of the buried part of the pipeline. Regular monitoring can be accomplished now that a full-time inspector has been assigned to Alaska, and he is operating out of a joint office that allows each agency to leverage its resources in the state.

- o The Task Force has undertaken, as part of its work plan, to require monitoring of the performance of sleeves that have been installed to reinforce those sections of the buried pipeline that have experienced settlement.
- o Monitoring of other geologic hazards belongs to the DOI and to the State of Alaska through their responsibility for assuring

compliance with the terms of the permits they issued to Alyeska. RSPA will, as needed, obtain geotechnical expertise to monitor Alyeska's activities to protect its pipeline and terminal facilities from geologic hazards.

POSITION STATEMENT: Regulators Have Not Required Alyeska to Test Its Leak Detection System.

GAO Finding:

- o Alyeska has not been required to test fully its automatic leak detection system to see if it works. However, none of the spills, including one of 15,000 barrels, which have occurred since the pipeline commenced operation in 1977, has been detected by the automatic system (pp. 5, 33, 35-37).
- o A leak detection system is required under both Federal and state right-of-way agreements as well as RSPA regulations (p. 77).

The Department's Response:

To the best of the Department's knowledge, GAO is correct in its determination that Alyeska has not tested its automatic leak detection system to see if it would identify leaks at the sensitivity levels Alyeska has established in its operating plan (e.g., 600 to 3,000 barrels per day depending on the turbulence of the flow) (p. 36). The draft report is not correct in stating that RSPA's regulations require a leak detection system (p. 77).

- o The hazardous liquid pipeline safety regulations (49 CFR Part 195) do not require the installation of a leak detection system per se; the regulations do require that pipeline operators monitor their systems for abnormal operating conditions, and take corrective action when such conditions are identified. Also, operators are required to respond quickly to emergency situations including failures involving the release of hazard liquids.
- o RSPA has included a study of Supervisory Control and Data Acquisition (SCADA) methods (including leak detection capabilities) in its 1992 budget. Based on the outcome of the study, RSPA may issue regulations requiring the use of such systems.

GAO Recommendation:

- o Require Alyeska to test its leak detection system at various levels of pipeline operations to determine what levels will trigger an alarm and decide if these sensitivity levels meet operating requirements (p. 47).

See comment 16.

**Appendix IV
Comments From the Department
of Transportation**

The Department's Response:

The Department agrees with GAO that Alyeska should be required to test its leak detection system.

- o In accordance with its responsibilities under its spill contingency plan, which BLM and the pertinent state agencies recently approved, Alyeska will be testing its leak detection system late this summer. RSPA will witness that testing.

See comment 5.

Comments From the Environmental Protection Agency

Note: GAO comments supplementing those in the report text appear in appendix VII.



UNITED STATES ENVIRONMENTAL PROTECTION AGENCY
WASHINGTON, D.C. 20460

APR 29 1991

OFFICE OF
POLICY, PLANNING AND EVALUATION

Mr. Richard L. Hembra
Director, Environmental Protection Issues
Resources, Community, and Economic Development Division
General Accounting Office
Washington, D.C. 20548

Dear Mr. Hembra:

The U.S. Environmental Protection Agency (EPA) has reviewed the General Accounting Office (GAO) draft report entitled "Trans Alaska Pipeline: Regulators Have Not Ensured That Government Requirements Are Being Met." In accordance with Public Law 96-226, I am hereby providing the formal Agency response to the draft report.

GAO has rationally characterized the need for additional and coordinated oversight by State and federal agencies. In addition, the draft report identifies ways of enhancing our current effort and explores the resulting impacts and implementing constraints. In this draft, GAO has addressed our earlier concerns about competing priorities and their impact on EPA's Regional Water Management Division's ability to support a joint Alyeska oversight office. GAO has also clearly identified the need for consistent long-term funding if additional support for Alyeska oversight activities is to be provided.

On page 7, GAO states that EPA has not joined the Alyeska oversight office for the Trans-Alaska Pipeline System (TAPS). Please note that EPA is currently considering participation in this effort.

On page 48, GAO presents a recommendation that the EPA Administrator, in cooperation with other federal and State agencies, "develop regulations to ensure federal or state oversight of the integrity of the crude oil storage tanks at the Valdez terminal." The Oil Pollution Prevention regulation (40 CFR Part 112) applies to the terminal facility at Valdez, Alaska, and requires that owners and operators of certain non-transportation related facilities, including owners of above-ground storage tanks, prepare and implement a Spill Prevention, Control and Countermeasures (SPCC) plan.

See comment 17.

**Appendix V
Comments From the Environmental
Protection Agency**

See comment 18.

In January, 1988, EPA formed an interagency task force to study federal regulatory programs for preventing releases of oil from above ground storage tanks. The Oil Spill Prevention, Control, and Countermeasures Program Task Force (Task Force) issued its report on May 13, 1988. Based on the recommendations of this Task Force, EPA is modifying the Oil Pollution Prevention regulation to make certain practices more clearly mandatory, to require facility-specific contingency planning, and to make other changes in the regulation. The task force report included an implementation schedule that assumed major recommendations could be implemented within five years. We recommend that, in preparing its final report, GAO also consider evaluating its conclusions based on establishing recommendations within a realistic implementation period. We have enclosed a copy of EPA's current regulatory schedule for these changes.

See comment 19.

Following the last line of the middle paragraph on page 66, a sentence should be added to reflect that EPA has a commitment to pursue development of bio-remediation techniques, has convened a Bio-Remedial Action Committee to look for ways of using bio-remediation for the clean-up of oil spills, and has several research and development projects that focus on bio-remediation as a clean-up process.

See comment 19.

The top paragraph of page 72 states that the five federal and state regulatory agencies responsible for monitoring and assessing TAPS' operations were not proactive in ensuring safe operations. We note that EPA has been actively involved in the development of the Regional Response plan required under the National Contingency Plan (NCP) and in identifying methods and approaches to prevent and mitigate discharges of oil through its research and regulatory programs described above.

See comment 20

We believe the last sentence of the first paragraph on page 75 concerning EPA's uncertainty about its regulatory jurisdiction over tanks at the Valdez oil terminal is inaccurate. The statement appears to conflict with other statements made in the paragraph concerning EPA's inspection of facilities subject to the regulation of the SPCC program. The Oil Pollution Prevention regulation applies to any non-transportation related facility. The size and other cutoff limitations contained in the regulation are not applicable to the Valdez facility. A Memorandum of Understanding (MOU) between EPA and the Department of Transportation is contained as an appendix to the regulation. The MOU defines the term "non-transportation related", and the Valdez facility is clearly a non-transportation related facility. Therefore, we believe that EPA's jurisdiction under 40 CFR Part 112 over the storage tanks at the Valdez terminal is clearly established. The same issue applies to the last full sentence on page 77.

Appendix V
Comments From the Environmental
Protection Agency

In response to the last sentence of the first paragraph on page 78, EPA agrees that better coordination among agencies is important and is in the process of addressing this issue through its possible involvement in the Alyeska coordinating office.

The third paragraph of page 80 states that there is no clear leader that will ensure adequate oversight and that TAPS should be subject to a systematic and disciplined oversight approach. Although EPA would not be the lead agency, it agrees that an identified lead agency is needed to coordinate inspections, enforcement actions, follow-up efforts, and other aspects as appropriate. In its implementation of the appropriate provisions of the Oil Pollution Act (OPA) of 1990, EPA is revising the SPCC regulation and other regulations, and is identifying various related requirements of other federal and State programs and incorporating or referencing them in the SPCC regulation, as appropriate, to avoid unnecessary duplication or neglect. EPA has been involved in exploring methods of increasing State involvement in the SPCC program. Currently, an analysis of existing State SPCC related programs is being prepared. These actions should assist in the coordination of federal and State efforts in TAPS.

On page 82, first full paragraph, the need for a consistent source of funding is discussed with the suggestion to reimburse all reasonable oversight costs similar to what is now required for the Bureau of Land Management. EPA believes that this may be an appropriate method of reimbursement and would like to explore other options.

Thank you for the opportunity to comment on the draft report.

Sincerely,

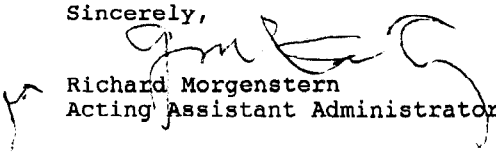
Richard Morgenstern
Acting Assistant Administrator

Enclosure

Comments From the State of Alaska

Note: GAO comments supplementing those in the report text appear in appendix VII.

STATE OF ALASKA

DEPARTMENT OF NATURAL RESOURCES

OFFICE OF THE COMMISSIONER

WALTER J. HICKEL, GOVERNOR

P.O. BOX 107005
ANCHORAGE, ALASKA 99510-7005
PHONE: (907) 762-2483

April 2, 1991

Letter No: 91-51-M
File No: 3050.01

Mr. James Duffus III, Director
Natural Resource Management Issues
United States General Accounting Office
441 G. Street, N.W.
Washington D.C. 20548

Re: 1991 GAO Report of the Trans-Alaska Pipeline System

Dear Mr. Duffus:

This response has been coordinated with the Governor's Office, the Alaska's Departments of Environmental Conservation, Fish and Game, and Law. The State of Alaska has reviewed your audit of the Trans-Alaska Pipeline System (TAPS), and believes it is not subject to the GAO's regulatory purview. We did however, voluntarily participate in your audit and will take actions to correct deficiencies in our TAPS monitoring program. The report is broken into (2) sections:

- A) General Comments
- B) Specific Page by Page Review included in ATTACHMENT "A"

General Comments

Alaska fully recognizes that previous State administrations could have increased its regulatory presence along the Trans-Alaska Pipeline System (TAPS). However, your audit as presented, does not reflect the current level of effort either the State of Alaska or the United States Government is devoting to monitoring the TAPS, and this new detailed approach must be discussed to give an accurate picture of TAPS monitoring. Your audit time should be 1985 - February 1991, rather than 1985 - 1989.

Without this period discussed, a reader could make an erroneous decision and cost the tax payers needless time, money, and confusion. The Hickel Administration has established a proactive approach to monitor the TAPS in order to ensure that it is operated in a safe and environmentally sound manner and will be available to bring ANWR oil to market. Your report makes many recommendations and we agree with the direction you want to take to ensure the TAPS integrity. We do not agree with excluding the 1989 - 1991 progress nor do we agree that the joint office needs Washington D.C.'s oversight to manage TAPS. We would consider the

See comment 1.

See comment 14.

Appendix VI
Comments From the State of Alaska

Mr. Duffus - 1991 GAO Report

-2-

April 2, 1991

failure of GAO to correct the body of its audit with current status indicated in our review comments as egregious breach of its charter and a black mark on its reputation for professionalism.

We believe Alaska is capable of managing its resources and can ensure TAPS integrity is preserved to deliver future oil fields to market. We also believe the present level of monitoring of the TAPS exceeds standards for other common carrier pipelines in California, Texas, and other oil states. TAPS monitoring should not be treated in isolation from other world pipelines.

The State is willing to work proactively with the GAO, Congress, and other agencies to ensure that we have safe, well designed, and operating pipelines in Alaska. Further, we believe GAO has pointed out a number of valid deficiencies and these will be addressed in our pipeline work program.

The re-creation of the Joint Federal/State Pipeline Monitoring Office was resurrected officially in July 1990. In this short time we have:

- 1) Completed a detailed review of the TAPS Pipeline Oil Spill Contingency Plan and required Alyeska to improve the plan by implementing 762 actions at an estimated cost of \$50 million dollars;
- 2) Developed joint working agreements with all State agencies;
- 3) Developed a cooperative working agreement with Federal DOT/OPS, and the Bureau of Land Management;
- 4) Developed a corrosion work plan;
- 5) Completed an audit of Alyeska's Corrosion Testing Program;
- 6) Developed a draft Right-of-Way Monitoring Plan;
- 7) Developed project schedules and work programs for Alyeska's scheduled construction; and
- 8) Monitored the replacement of 9 miles of pipeline at the Atigun River

The joint office is also developing a work program, schedule, and system analysis for Yukon Pacific Corporation Gas Pipeline Projects.

The State believes that the joint office is an effective means to monitor TAPS. It allows multi-agency (State and Federal) expertise and oversight to be utilized without duplicating effort and it gives industry a clear, coordinated up front guidance on governmental requirements to conduct their projects.

See comment 1.

Mr. Duffus - 1991 GAO Report

-3-

April 2, 1991

Alaska appreciates your constructive criticism and will proceed to rectify deficiencies. Please refer to our detailed comments in ATTACHMENT "A".

Sincerely,

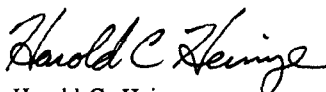

Harold C. Heinze
Commissioner DNR

cc: Honorable Walter Hickel, Governor of Alaska
Max Hodel, Special Assistant
John Katz, Special Assistant
Charles Cole, Attorney General, DOL
John Sandor, Commissioner, DEC
Carl Rosier, Commissioner, DF&G
Jerry Brossia, State Pipeline Coordinator, DNR
Mead Treadwell, Deputy Commissioner, DEC
Doug Mertz, Assistant Attorney General, DOL
Mike Menge, Chief, BLM/BPM
James Hermiller, President, Alyeska
Sterling Liebenguth, GAO
Honorable Ted Stevens, United States Senate House
Honorable Donald Young, United States House of Representatives
Honorable Frank Murkowski, United States Senate House

GAO Response to Agencies' Comments

1. The report covers the 5-year period before the Exxon Valdez incident as well as actions the regulators have begun taking since that time. The report has been clarified where appropriate, and it has been updated as of April 1991 to reflect new information regarding the activities of the joint monitoring office. However, although we believe the joint office is an important step towards achieving a systematic, disciplined, and coordinated oversight approach, we believe that further steps are necessary.
2. We disagree. Our report reflects a thorough analysis of the regulatory oversight that has occurred over the last several years to ensure TAPS' operational safety, oil spill response capabilities, and ability to protect the environment. To assess the adequacy of the regulators' oversight, we started out with a list of the regulators' own requirements and asked them if they could tell us whether Alyeska adequately addressed them. For the most part, they could not. Our criteria for assessing the regulatory oversight are clearly spelled out in both chapters 1 and 5 and include information on whether the regulators have clear and enforceable requirements, adequate numbers of well-trained staff, and adequate coordination between the responsible federal and state regulators.
3. At the time we conducted most of our audit work, 13 years after the pipeline began operating, the regulators were unable to tell us, among other things, (1) whether Alyeska's corrosion prevention and detection systems were adequate, (2) whether the computerized leak detection system worked at the sensitivity threshold level advertised by Alyeska, and (3) whether the contingency plan would ensure that the leadership, coordination, communication, equipment, and personnel mobilization necessary in the event of a large-scale spill was adequate. Although Interior contends that Alyeska has willingly worked in harmony with the Department, we do not believe that this is a substitute for a systematic, disciplined, and coordinated oversight approach by the agencies charged with ensuring TAPS' operational safety, oil spill response capabilities, and ability to protect the environment.
4. The report has been updated to reflect actions taken after the formation of the joint office in 1990 regarding the corrosion prevention and detection system.
5. We have acknowledged the actions taken by agencies and/or the joint office to implement the intent of the recommendations contained in the body of our report.

6. Although Interior has said that it visually surveys the pipeline periodically for geologic hazards, we found no evidence of systematic monitoring of the effectiveness of Alyeska's design and surveillance and maintenance activities to address these concerns. Interior and the state agree that a more structured oversight program, including documenting their reviews, is needed in the area of geologic hazards.

7. Our report states that no regulatory agency was overseeing the Valdez terminal. We believe oversight applies to more than just oil spill contingency planning. One of the more significant areas that was not inspected for years was the integrity of the 18 oil storage tanks. In our report we point out that while BLM, the state, EPA, and Transportation all had access to the terminal, and could have inspected it under their respective authorities, limited oversight occurred. We also acknowledge that EPA is revising and will enforce its regulations to cover procedures for inspecting tanks to ensure their integrity, as well as continue to enforce other Spill, Prevention, Control, and Countermeasures (SPCC) requirements.

8. Before the Exxon Valdez incident, BLM attended less than half of the drills that Alyeska conducted and did not play an active role in them. We acknowledge that BLM and the state recently agreed with Alyeska to institute a new system for drills which will require them to play a more active role.

9. Although Alyeska currently tests pieces of its contingency plan, we continue to believe that a full-scale drill, designed to test the leadership, coordination, communication, and equipment and personnel mobilization that would be needed to locate, contain, and clean up a large-scale spill is essential. Alyeska's poor response to the Exxon Valdez spill would indicate that adequate preparation is crucial to the timely response to a large-scale spill. In commenting on a draft of this report, the regulators and Alyeska believe that this type of drill would require a shutdown of the pipeline. We believe there may be other options available. Alyeska could simulate an oil spill, similarly to what it does now for some of its drills. The state suggests that this type of drill could be conducted when the line is shut down for maintenance purposes. Additionally, both Interior and the state have indicated that they have scheduled a test of the leak detection system—it may be feasible to conduct the drill at that time.

10. The joint office is using the data we collected and provided to the office during the course of this audit to develop a data base of environmental studies completed to date. However, protecting the environment was a preeminent concern for the Congress when the project was approved, and 14 years after TAPS began operating, there is still no long-term systematic monitoring strategy. Baseline data, as well as subsequent studies on specific species or resources, are needed to conduct a long-term assessment of TAPS' impact on the environment. This is why we also recommended that the regulators review the studies that have been done to date and prioritize additional research needed.

11. It was not our intent that a single cleanup standard be established. However, we do believe that in the event of a spill, it is important for Alyeska, as well as the regulators, to have already researched and studied what it takes to clean up a spill and, since total removal is often not possible, what level they need to clean up to.

12. The report has been updated as appropriate to reflect recent agency actions to evaluate and study new advances in oil spill cleanup technology.

13. This report covers actions taken by the regulators from 1985 to April 1991. The report has been clarified to acknowledge Transportation's monitoring of pipeline settlement in 1989.

14. We believe that central leadership, a secured funding source, and full-time participation of all of the significant regulators may help ensure adequate oversight of the pipeline. We have not specifically recommended that the lead agency be designated by statute. We have modified our Matter for Consideration to address the need for funding of the joint office.

15. We disagree that Transportation's oversight before the discovery of corrosion was adequate. Transportation, as well as Interior and the state, were well aware of hundreds of coating and taping deficiencies identified during pipeline construction. As stated on page 5 of the Department's response, because of these concerns, Transportation recommended periodic pigging of the pipeline. We believe that given these concerns, close monitoring by the regulators was warranted.

16. The report has been clarified to reflect the Department's requirements for leak detection.

17. The report has been updated to reflect that EPA is considering participating in the joint office.

18. The report has been revised to reflect the actions being taken by EPA to revise regulations to ensure storage tank integrity.

19. The report has been updated to reflect EPA's research of oil spill prevention and mitigation.

20. We recognize that EPA has inspected the Valdez terminal for compliance with Spill, Prevention, Control, and Countermeasures planning requirements. However, we are specifically referring to ensuring the integrity of the 18 oil storage tanks. During the course of our review, we met with EPA and Transportation officials in Washington, D.C., as well as regional offices. During those meetings, it was apparent that there was confusion as to which agency was responsible for inspecting the tanks' integrity. As a result of an interagency SPCC task force, it was recently decided that although both agencies had jurisdiction under their respective legislative authorities to monitor storage tank integrity, EPA would revise its regulations to ensure oversight over tank integrity. Although EPA indicates that it is revising its regulations and has provided us with a schedule for their development, there is still some confusion. An attachment to the state's comments indicates that the state believes that Transportation will monitor storage tank integrity.

Comments From Alyeska Pipeline Service Company

Note: GAO comments supplementing those in the report text appear in appendix IX.

Alyeska pipeline

SERVICE COMPANY

1835 SOUTH BRAGAW STREET, ANCHORAGE, ALASKA 99512. TELEPHONE (907) 278-1611. TELEX 090-25-127

April 18, 1991

Mr. James Duffus II
Director
Natural Resources Management Issues
U. S. General Accounting Office
441 G Street, N.W.
Room 215
Washington, D.C. 20548

Dear Mr. Duffus:

Alyeska Pipeline Service Company (Alyeska), as agent for the Owners of the Trans Alaska Pipeline System (TAPS), is pleased to submit its comments on GAO's draft report concerning federal and state regulatory oversight of TAPS. Alyeska is troubled that the conclusion of the draft report -- that greater regulatory oversight of TAPS is required -- implies that the pipeline system is not well run. We believe the record clearly shows the contrary: TAPS is an efficiently run, safe and environmentally sound pipeline system.

We believe GAO has significantly underestimated the involvement of federal and state agencies in the operations of TAPS in concluding that TAPS has not been adequately overseen by regulators. We maintain that Alyeska has had a constructive, open working relationship with the agencies since the pre-construction era, which has been of significant benefit to the operation of TAPS.

We are submitting with this letter a separate detailed set of comments on the draft report which we trust will be considered in the preparation of the final report. For your convenience and to satisfy your page limitations for inclusion in the final report, the balance of this letter summarizes the major points contained in our detailed comments.

1. Alyeska's Corrosion Minimization and Detection Programs

All steel pipelines are subject to corrosion. The goal of any program to deal with the potential for corrosion is to limit its occurrence and to detect it before a hazard arises. Alyeska's corrosion program meets this goal. There have been no leaks from the mainline pipe due to corrosion in the entire history of TAPS. Generally, the mainline pipe corrosion is

See comment 1.

See comment 2.

Appendix VIII
Comments From Alyeska Pipeline
Service Company

Mr. James Duffus II
April 18, 1991
Page 2

external, primarily affecting only the below-ground portion of the pipeline, roughly half of the pipeline's total length. The majority of the corrosion affects a few areas and is equivalent to only about two percent of the 800-mile pipeline.

Alyeska's record results in part from its employment of the world's most sophisticated corrosion detection devices to identify the sites of potential corrosion. Through a series of runs of "smart pigs" that ultrasonically or electro-magnetically detect defects in the pipe and subsequent excavations of portions of the pipe containing defects, Alyeska maps the condition of the below-ground pipe. When significant corrosion is discovered, Alyeska makes appropriate repairs.

Alyeska invites comparison of its corrosion minimization, detection and repair programs with those of any pipeline in the world. For example, a suitable corrosion detection pig that ultrasonically analyzes the thickness of the pipe wall did not exist for use on a large diameter pipeline before the NKK Corporation, working with Alyeska since 1984, produced it in 1988. This highly sophisticated device can detect thinning of the pipe wall of as little as 10% of the pipe wall thickness (thinning of less than 1/16th of an inch). Most crude oil pipelines use magnetic flux corrosion detection pigs. Magnetic flux technology is not as sensitive as ultrasound and, in Alyeska's experience, may not discover corrosion until it is fairly significant. Even with the magnetic flux pig, however, Alyeska has worked to increase its sensitivity so that it can detect a less severe thinning of the pipe wall.

2. Lack of Correlation Between Noncompliance Citations and Identified Corrosion

In Chapter 2 of the Draft Audit Report, GAO suggests that noncompliance citations concerning the coating and taping of the pipeline that were issued during construction of the pipeline are related to the corrosion that has been experienced. However, none of these coating and taping noncompliance citations relate to the area in which severe corrosion was concentrated -- the Atigun River Floodplain. Because the non-compliance citations do not relate to the area most affected by corrosion, they are irrelevant.

Damage to taping and coating, in and of itself, does not lead to corrosion. While the coating and taping have been penetrated in some pipeline locations, such breaches in the covering do not impede the cathodic protection of the pipe. Alyeska's annual surveys of measurements that indicate the voltage of the cathodic protection of the pipe provide evidence of the effective performance of the system. Approximately a half

See comment 3.

Mr. James Duffus II
April 18, 1991
Page 3

million such measurements are taken for each annual survey. The results of these surveys are in compliance with the Department of Transportation's regulations.

3. Experience of Computerized Leak Detection System

GAO states that the line volume balance leak detection system has failed to detect a leak, including the largest leak which occurred in 1978, and that this indicates a deficiency in Alyeska's computerized leak detection system. This is misleading. Alyeska's computerized line volume balance leak detection system currently in place differs significantly from the system that was in place up to December 1979. A working group that included representatives of the Bureau of Land Management (BLM), Alaska Department of Natural Resources (ADNR) and Alaska Department of Environmental Conservation (ADEC) operating while the audit was being conducted, has recently found Alyeska's current computerized system for detecting leaks from the pipeline to be among the most advanced systems available. They evaluated the system as part of a review of the pipeline's oil spill contingency plans. The group reached this conclusion after it examined other sophisticated systems for detecting leaks and after it inspected other pipelines in the United States.

Moreover, the line volume balance system has been substantially improved over the past 11 years. Since 1979, Alyeska and BLM have reviewed the system and have recommended changes to the software used in making line volume balance calculations. More sophisticated and accurate instrumentation for the line volume balance system has been developed and installed. As a consequence of these improvements, the system is more reliable now than it was in 1979. It is therefore misleading to refer to spills that occurred before late 1979 as indicating limitations on the capabilities of Alyeska's current system.

Since the overhaul of the computerized line volume balance leak detection system the only spill of any size from the mainline pipe of TAPS was a spill from Check Valve 23 in early 1981. This spill was visually detected within a very short time of the occurrence of the leak. As a result, insufficient time elapsed for the computerized portion of the leak detection system to alarm. Swift visual surveillance is not an indication of any deficiency in the computerized leak detection system.

See comment 4.

Mr. James Duffus II
April 18, 1991
Page 4

See comment 5.

4. Sensitivity Level of Computerized Leak Detection System

Neither the Agreement and Grant of Right-of-Way nor BLM's approval of Alyeska's compliance with the Stipulation for leak detection require a specific sensitivity level to be met. Instead, BLM has approved the system in place as satisfying the stipulation, which is essentially a technology standard rather than a performance standard. The reason for BLM's approval is that the leak alarm threshold on so dynamic and large a pipeline as TAPS must be variable. A system's sensitivity should be measured not by the point at which it alarms, but the point at which it reliably alarms. As a consequence, to have a reliable alarm while taking into account variations in the conditions for this dynamic system, the leak alarm threshold must be variable. BLM has participated from the early 1980s to the present in recommendations for refinements to the line volume balance portion of the computerized leak detection system.

See comment 6.

5. Geological Hazards

Alyeska, in its design, monitoring, and maintenance of the pipeline has taken pains to reduce the risks posed by each of the geological hazards in the arctic environment. In nearly every instance, GAO has not acknowledged Alyeska's engineering response to geological hazards. Instead, each peril is recited, with the implication that the pipeline, as it is currently being operated and maintained, is at grave risk. Alyeska employs a comprehensive monitoring and surveillance program to reduce the potential that risks, should they materialize, would damage the pipeline.

The risk of settlement of the buried pipeline due to thawing of the permafrost led to the burial of the pipeline in areas of competent bedrock or frozen ground comprised of soils that are stable even if the permafrost thaws. In areas where a significant risk of avalanches, landslides or rockslides exists, the pipeline is buried and the permafrost is protected with insulation or refrigeration if necessary. Where the pipe is above-ground, heat exchangers on some of the vertical support members that support the pipeline protect the permafrost against thawing. Alyeska's settlement monitoring program, which includes its analyses of the temperature of the permafrost, are designed to guard the pipeline's continued integrity despite the presence of permafrost.

The risk of earthquakes was addressed in the pipeline's design and construction with the goal to eliminate the risk of an oil spill from the maximum expectable earthquake. The design has successfully withstood the many earthquakes that have occurred in

Mr. James Duffus II
April 18, 1991
Page 5

the vicinity of the pipeline route over the history of the pipeline.

TAPS was also designed, engineered and constructed to minimize the risk of unstable slopes. First, slopes were cut in such a way as to ensure their stability without the need for additional stabilization methods. Second, on slopes for which a risk to stability remained, the slopes were reinforced with rock bolts, equipped with drainage systems to reduce the hydrostatic pressure or were both bolted and drained. For some slopes, particularly at the Valdez Marine Terminal, bolts and drains were installed as an extra margin of safety even though the slopes had been deemed by experts to be safe under all expectable conditions. Alyeska monitors the slopes for their continued stability.

The over 800 river and stream crossings of the pipeline also have not presented problems. At these crossings, the pipe was generally buried and has sufficient cover to withstand cyclical removal of the sand and gravel over it. Decisions on the sufficiency of the cover are based upon annual overflights of each crossing, as well as historical profiles of each crossing. These historical profiles include the data obtained in the original surveys of the crossings at the time of construction, updated in inspections and surveys of each stream or river crossing at two, three or five year intervals depending on river and stream dynamics.

Alyeska strongly disagrees with GAO's conclusions that inadequate baseline data exist for evaluating changes to waterways that may affect TAPS's operations. Baseline data for each waterway is updated regularly with empirical data obtained through Alyeska's overflights and surveys of waterways.

6. Oil Spill Response Capability

No contingency plans in the world have been subject to greater scrutiny or a more open review process than the oil spill contingency plans for TAPS. For the past two years -- the entire time during which GAO was conducting this audit -- Alyeska, the Bureau of Land Management, the Alaska Department of Natural Resources and the Alaska Department of Environmental Conservation have been reviewing and recommending revisions to the 1987 contingency plan. Although the 1987 plan had been reviewed and approved by the appropriate authorities, this group examined the issue of contingency planning for the pipeline from square one. This review included: (1) scrutiny of the assumptions underlying past contingency planning efforts; (2) an assessment of the risks of spills along the pipeline; (3) evaluation of the equipment and techniques used for oil spill response; (4) analysis of Alyeska's

See comment 7.

See comment 8.

Mr. James Duffus II
April 18, 1991
Page 6

leak detection system and alternative systems; (5) the proper elements of drills; and (6) training of employees and contractors for oil spill response.

The results of this review were incorporated into the contingency plan for the pipeline submitted in December 1990 and the contingency plan for the terminal submitted in January 1991. These plans were subject to extensive public comment and review. On April 3, 1991, the pipeline plan was approved with a May 1, 1991 effective date. Alyeska submitted an Implementation Plan with the Pipeline Oil Spill Contingency Plan. The Implementation Plan sets out Alyeska's tentative schedule for acquiring additional equipment and adding other features that will enhance its oil spill response capability.

Moreover, while the last two-year review by BLM, ADNR and ADEC was still in progress, Alyeska made a number of major changes to its oil spill response capability. With owner approval, Alyeska began implementing certain portions of the Implementation Plan prior to Oil Spill Contingency Plan approval. Additional oil spill response equipment has been purchased and additional containment sites have been constructed. Alyeska has revamped its training program for oil spill response to emphasize hands-on training and has increased the training time expected of all response personnel.

GAO recommends that Alyeska be required to conduct a comprehensive, line-wide mobilization drill simulating response to a large scale oil spill. The newly approved Oil Spill Contingency Plan does not require the type of drill GAO is suggesting. Alyeska and the regulators have exhaustively reviewed the proper format for drills and decided to retain the structure used in the past with the addition of the Incident Command System. The Incident Command System, together with a Field Response System, provides for a coordinated and systematic response mechanism for any sized oil spill.

GAO's recommendation for full mobilization drills in response to large scale simulated leaks is unwise. While Alyeska regularly conducts drills of its oil spill response capabilities, it has never conducted a drill mobilizing the people and equipment that would respond to a large scale oil spill because doing so would unnecessarily increase operational and environmental risks and the risk of a spill.

In the event of a large scale leak, the pipeline would be shut down within minutes of the leak's detection and all pipeline operation personnel would provide initial response to the oil spill clean-up effort. A line-wide simulation, including equipment mobilization, as suggested by the GAO would therefore

See comment 9.

Mr. James Duffus II
April 18, 1991
Page 7

require shutting down the pipeline for the duration of the drill so as not to compromise safety. We believe segmented drills as outlined in the new spill plans will achieve comparable results without posing operational hazards.

A comprehensive mobilization drill could also cause environmental damage from mobilization of equipment and the movement of equipment off the work pads. While the disturbance of the area around the pipeline is minimized by the plan for cleaning up an actual spill, some impact is unavoidable. Alyeska does not view this unavoidable environmental harm to be justified simply for the sake of drills.

7. Environmental Impacts

The Environmental Impact Statement (EIS) for TAPS, prepared by an interdisciplinary team of scientists, studied the condition of the right-of-way route and projected the impacts of the construction and operation of TAPS. The EIS's information and references provide data for assessing the environmental impact of TAPS. The EIS cites close to 700 studies that relate to the environmental impact of TAPS. Congress debated and ultimately approved the adequacy of these studies in the Trans Alaska Pipeline Authorization Act. Additionally, the 1981 GAO report examined this issue and did not find that baseline data was lacking. Moreover, during the past ten years, Alyeska has commissioned over twenty studies into the status of wildlife and aquatic diversity, populations and habitat, and restoration of an oil spill site, as well as the health of the environment in the vicinity of the pipeline. These studies show that the environment and wildlife are not significantly affected by TAPS and observation bears this out. We do not believe it is the intent of the GAO to discredit all of the above research based on the limited contradictory studies that it has cited in the draft report.

8. Regulatory Oversight

Alyeska disagrees with GAO's findings of deficiencies in the regulation of TAPS and its recommendation for replacing the joint office, that has been newly formed by BLM, the Office of Pipeline Safety (OPS), ADNR and ADEC, with another federally established commission. This suggestion fails to take into account the increased regulatory scrutiny to which TAPS has been subject since 1989 and the creation of a joint office of state and federal regulators. The new joint office has been assessing Alyeska's corrosion minimization and detection programs, along with other issues facing the pipeline. Evidently, GAO's cut-off of the audit review period at 1989 has excluded this evidence from the analysis underlying this report. Without an

See comment 10.

See comment 11.

Mr. James Duffus II
April 18, 1991
Page 8

appreciation of recent history, a conclusion on this point is unwarranted.

It is also important to note that both Congress and the Alaska legislature recently established citizens' oversight groups to monitor aspects of Alyeska's operations or the action of its oversight agencies. Both acted on the assumption that citizens concerned with the impact of business activities on their daily lives would bring a useful perspective to the regulatory process. The draft report fails to consider the potential benefit to regulators of these citizen efforts.

In concluding, Alyeska does not wish to leave the impression that it is opposed to scrutiny of its operations. We are receptive to improving the efficiency of our interaction with those agencies which oversee and regulate our business. We believe, however, that the framework for vigorous and comprehensive regulatory and citizen oversight is in place. We would urge GAO to consider our comments in that light.

Very truly yours,

James B. Hermiller
President

Enclosures

GAO Response to Alyeska's Comments

1. Given the significance of the TAPS system, we believe that more systematic, disciplined, and coordinated regulatory oversight is needed. While there has been some regulatory presence over the years to monitor TAPS, the evidence indicates that for our review period, and certainly before the Exxon Valdez accident, regulatory oversight was limited. For the most part, Interior, Transportation, EPA, and the state agree that this has been the case. They believe that the joint office, founded in 1990, will provide the necessary oversight.
2. We have made it clear throughout the conduct of our review that we were not evaluating the adequacy of Alyeska's actions, but rather were evaluating how well the regulators have ensured TAPS' operational safety, contingency planning, and ability to protect the environment. The regulators should have been in a position to independently evaluate the adequacy of Alyeska's actions to address various regulatory requirements. For example, we note that Alyeska developed a three-part corrosion prevention and detection system—(1) coating and taping, (2) cathodic protection, and (3) "smart" pigs; however, the federal and state regulators should have assessed the adequacy of these systems—something that they indicated they are now doing as part of the joint office.
3. We disagree. Summary reports we obtained from BLM relating to non-compliance reports issued for coating and taping deficiencies clearly indicate that 96 instances of noncompliance were noted in the construction section where TAPS is experiencing its most severe corrosion problems. The coating and taping deficiencies found at this location are consistent with those identified in the noncompliance reports issued elsewhere along the pipeline and noted in BLM's summary reports. We believe that the regulators should have closely monitored the areas identified in these reports, as coating and taping deficiencies may be a contributing cause for the current corrosion problems.
4. We believe that the report adequately covers the improvements discussed in the comments that Alyeska has made to the computerized leak detection system.
5. Interior, Transportation, and the state all agreed that the computerized leak detection system should be tested to see if it works at stated threshold levels. A test is scheduled for July 1991.
6. In each section under the geological hazards section—slope stability, permafrost thaw, and river erosion—we identify the design measures that Alyeska developed and built into the system as well as surveillance

and maintenance procedures Alyeska uses to monitor the hazards and how well their designs have held up. We point out, however, that the regulators have not systematically assessed Alyeska's monitoring and surveillance program for reducing the potential risk to the pipeline from geologic hazards.

7. This section has been revised to delete references to baseline data and clarified to focus on the lack of regulatory oversight in this area.

8. We have updated sections, as appropriate, throughout the report to reflect that the regulators, along with Alyeska, reviewed the contingency plan in detail and in April 1991 had approved a new plan.

9. Although Alyeska currently tests pieces of its contingency plan, we continue to believe that a full-scale drill, designed to test the leadership, coordination, communication, and equipment and personnel mobilization that would be needed to locate, contain, and clean up a large-scale spill is essential. The problems that Alyeska and Exxon encountered in responding to the Exxon Valdez spill would indicate that adequate preparation is crucial to timely response to a large-scale spill. The regulators and Alyeska believe that this type of drill would require a shutdown of the pipeline. Alyeska also believes that it will cause harm to the environment. We believe that there may be other options. It may be more appropriate for Alyeska to simulate an oil spill, similar to what it does now for some of its drills. The state suggests that this type of drill could be conducted when the line is shut down for maintenance purposes. Additionally, both Interior and the state have indicated that they have scheduled a test of the leak detection system—it may be feasible to conduct the drill at that time. While this type of exercise may cause some environmental damage, the experience of the Exxon Valdez incident would indicate that the environmental damage done as the result of not being prepared is far greater than the limited environmental damage that may be done in ensuring that Alyeska is adequately prepared to respond to a large-scale spill.

10. Protecting the environment was a preeminent concern for the Congress when the project was approved, and 14 years after TAPS began operating, there is still no long-term systematic monitoring strategy. Our 1981 report did not address baseline studies, but did recommend long-term monitoring. We did not intend to discredit the studies completed to date, but do recommend that the regulators review them and determine whether additional research is needed and prioritize that research. If required, baseline studies may be needed. The joint office is taking the

first step by using the data we collected and provided to the office during the course of this audit to develop a data base of environmental studies completed to date. The report has been clarified to focus on the need to review existing studies, prioritize needed research, and develop a long-term monitoring strategy.

11. After an extensive review of the regulatory oversight of TAPS, our evidence indicates that for our review period, and certainly before the Exxon Valdez incident, oversight was limited. For the most part, the regulators themselves do not dispute this. We believe that the establishment of the joint office is a positive step; however, we also believe that central leadership, a secured funding source, and full-time participation of all of the significant regulators may help ensure adequate oversight of the pipeline.

Major Contributors to This Report

Resources,
Community, and
Economic
Development Division,
Washington, D.C.

Robert W. Wilson, Assistant Director
Charles Cotton, Assistant Director
Patricia Gleason, Assignment Manager
Loren W. Setlow, Senior Geologist

Office of the General
Counsel, Washington,
D.C.

Stanley G. Feinstein, Senior Attorney

Seattle Regional Office

Sterling Leibenguth, Evaluator-in-Charge
Hugo W. Wolters, Site Senior
Julie Hartman, Staff Member

Arctic Environmental
Information and Data
Center, University of
Alaska, Anchorage

Sal V. Cuccarese, Consultant

Ordering Information

The first five copies of each GAO report are free. Additional copies are \$2 each. Orders should be sent to the following address, accompanied by a check or money order made out to the Superintendent of Documents, when necessary. Orders for 100 or more copies to be mailed to a single address are discounted 25 percent.

**U.S. General Accounting Office
P.O. Box 6015
Gaithersburg, MD 20877**

Orders may also be placed by calling (202) 275-6241.

United States
General Accounting Office
Washington, D.C. 20548

Official Business
Penalty for Private Use \$300

First-Class Mail
Postage & Fees Paid
GAO
Permit No. G100