

**GAO**

Report to the Chairman, Committee on  
Ways and Means; and the Chairman,  
Subcommittee on Oversight, Committee  
on Ways and Means, House of  
Representatives

---

March 1997

## TAX CREDITS

# Opportunities to Improve Oversight of the Low-Income Housing Program



---

---



United States  
General Accounting Office  
Washington, D.C. 20548

---

**General Government Division**

B-274542

March 28, 1997

The Honorable Bill Archer  
Chairman, Committee on Ways and Means

The Honorable Nancy L. Johnson  
Chairman, Subcommittee on Oversight  
Committee on Ways and Means  
House of Representatives

This report responds to your request to determine the characteristics of the residents and properties that have benefited from low-income housing tax credits as well as to assess the controls the Internal Revenue Service (IRS) and states have over program operations. It makes recommendations to IRS and the Office of Management and Budget on improving program operations.

As agreed with your offices, unless you publicly announce its contents earlier, we plan no further distribution of this report until 30 days from the date of this letter. At that time we will send copies of this report to the Secretary of the Treasury; Commissioner of Internal Revenue; Director, Office of Management and Budget; and appropriate congressional committees and Members of Congress. Copies will also be made available to others on request.

Major contributors to this report are listed in appendix VII. If you have any questions about this report, please contact James White on (202) 512-5594 or Judy England-Joseph on (202) 512-7631.

James R. White  
Associate Director, Tax Policy  
and Administration Issues

Judy England-Joseph  
Director, Housing and Community  
Development Issues

---

# Executive Summary

---

## Purpose

The low-income housing tax credit is currently the largest federal program to fund the development and rehabilitation of housing for low-income households. Under this program, states are authorized to allocate federal tax credits as an incentive to the private sector to develop rental housing for low-income households. The tax credits awarded may be taken annually for 10 years by investors in qualified low-income housing projects to offset federal taxes otherwise owed on their income. If all the credits authorized over a 10-year period were awarded by the states to completed housing projects and used by investors, the annual cost would be over \$3 billion.

As a part of the Committee's oversight of the tax credit program, the Chairman, House Committee on Ways and Means, asked GAO to determine the characteristics of the residents and properties that have benefited from tax credits as well as to assess the controls the Internal Revenue Service (IRS) and states have to ensure that (1) state priority housing needs are met; (2) housing project costs, including tax credit costs, are reasonable; and (3) states and project owners comply with program requirements.

GAO's analysis of the low-income housing tax credit program is based primarily on a survey of tax credit policies and procedures in 50 states and 4 additional jurisdictions that have delegated tax credit allocation authority. As a part of that survey, GAO reviewed 423 randomly selected housing projects to assess the application of state controls and to ascertain project costs and characteristics. Information based on the 423 housing projects provide a statistically representative picture of the tax credit projects that were placed in service in the continental United States from 1992 through 1994.

---

## Background

Congress established the low-income housing tax credit program as an incentive for developers and investors to provide affordable rental housing for households whose income is at or below specified income levels. The incentive was needed because rental income and other returns from investment in low-income housing would generally not be sufficient to cover the costs of developing and maintaining such properties. The program is jointly administered by IRS and state tax credit allocation agencies. Annually, IRS allocates tax credits to each state in an amount equal to \$1.25 per state resident. Under the Internal Revenue Code, the state agencies are responsible for determining which housing projects should receive tax credits and the dollar amount of tax credits each should

receive. In making these determinations, the states are to consider both housing needs and costs.

The Code gives states general guidance on how to consider needs and costs. The state tax credit agencies are required to have an allocation plan that identifies the states' priority housing needs and contains selection criteria for awarding credits to help meet those needs. Housing needs are intended to include consideration of such matters as the availability of low-income housing over extended periods of time. To ensure that no more tax credits are awarded than necessary to stimulate low-income housing development, the state agency is required to evaluate such factors as the reasonableness of development costs and the sources and uses of project funds.

After the state allocates tax credits to developers, the developers typically offer the credits to private investors. The private investors use the tax credits to offset taxes otherwise owed on their tax returns. The money private investors pay for the credits is paid into the projects as equity financing. This equity financing is used to fill the gap between the development costs for a project and the non-tax credit financing sources available, such as mortgages that could be expected to be repaid from rental income.

Generally, developers must place the projects in service within 2 years of credit allocation or return the credits to the state for reallocation to other projects. Investors can claim the credits to offset taxes otherwise owed on their tax returns for each year of a 10-year period called the "credit period" as long as a minimum percentage of the projects' units are rented to low-income tenants at restricted rents for a 15 year tax credit compliance period. Individual and corporate investors are to attach tax credit schedules to their income tax returns when they claim the credits.

Once projects have been placed in service, state agencies are also responsible for monitoring the projects for compliance with federal requirements concerning household income and rents and project habitability. If noncompliance is not corrected, IRS may recapture or deny credit for previously used or issued tax credits.

IRS is responsible for issuing regulations on state monitoring requirements, ensuring that taxpayers take no more tax credits than they are entitled to take, and ensuring that states allocate no more credits than they were authorized to allocate. IRS requires annual reports from the states on the

---

amount of tax credit allocations made in total and amounts awarded to individual projects. IRS also requires reports from states on findings of project noncompliance.

---

## Results in Brief

Given the results of its random sample, GAO estimates that about 4,100 low-income housing projects were placed in service during the period 1992 through 1994. The resident and property characteristics of the projects varied widely, as did the costs to build the projects. For these projects, GAO estimates that the states annually awarded tax credits with a potential value over their 10-year lifetime of about \$2 billion (about \$1.6 billion in present value terms), or about \$6.1 billion for the 3 years combined. States have programs in place for allocating tax credits and monitoring implementation of low-income housing projects, but policies and procedures differ among the states and some procedures, including certification of project costs and monitoring project compliance, should be implemented more effectively in some states. IRS monitors tax credit allocations through state reports and has been developing a program to evaluate taxpayer use of tax credits. However, IRS needs additional information to adequately monitor tax credit allocations and taxpayer compliance with credit program requirements.

GAO estimates that the average household income of residents of tax credit-funded low-income housing projects placed in service between 1992 and 1994 was about \$13,000, and that a substantial majority of the households had income levels considered “very low” by the Department of Housing and Urban Development. Also, GAO estimates that almost three-fourths of the households in these projects benefited either directly or indirectly from other housing assistance, such as rental assistance to residents or loan subsidies to project owners.

The low-income housing developments were located throughout the United States in both urban and rural areas, and the types of buildings varied from walk-up/garden-style apartments to high-rise apartments. Most were new construction, but some were rehabilitated. The average per-unit development costs were an estimated \$60,000, but they ranged from less than \$20,000 to more than \$160,000. GAO estimated the present value of the average tax credit cost per unit over the 10 year tax credit period to be \$27,300.

All the states had developed qualified tax credit allocation plans, required by the Internal Revenue Code to direct tax credit awards to meet priority

housing needs. The plans generally targeted the credits to the priority housing needs identified by the states. Consistent with the latitude given them in the Code, the states had defined and weighted the selection criteria for awarding credits in different ways. There was also considerable variation in their plans and in the data and analyses used in assessing housing needs.

Although all states had qualified allocation plans, GAO identified several additional factors that could affect the housing actually delivered over time. For example, some states used discretionary judgement in addition to the criteria in the allocation plans in making final credit allocation decisions. In addition, IRS and state data indicate that many tax credits that were initially allocated may not have been used. Further, the long-term economic viability of tax credit projects as low-income housing has not been tested because projects have not yet been operational beyond the credit period. Determining whether, or how, these factors affect the long-term delivery of low-income housing that meets state housing priorities was beyond the scope of this report.

In ensuring the reasonableness of project costs and estimating the amount of tax credits needed, state allocation agencies are dependent on information submitted by developers about sources of financing and uses of funds. All states had some cost control procedures in place that were intended to help ensure the reasonableness of the tax credits awarded to projects. Consistent with the flexibility in the Code, these cost control procedures varied. Although all but one state required some form of independent verification of cost and financing data, the scope of the required verifications varied from limited verification of some developers' cost information to independent audits conducted in accordance with established auditing standards. GAO observed that some projects lacked complete information on the sources and uses of project funds, and some did not include certification of key data used in determining the basis for the tax credit. Without verification of cost and financing information, states are vulnerable to providing more (or fewer) tax credits to projects than are actually needed.

States have established compliance monitoring programs consistent with IRS regulations, but GAO determined that not all states fulfilled the requirements of those programs in 1995. Several states conducted fewer than the agreed-upon compliance monitoring site visits or desk audits in their plans, and, because IRS regulations do not require states to report on the number of monitoring inspections they have made, IRS could not

determine states' compliance with their monitoring plans. In addition, IRS regulations do not require on-site inspections or other reviews to evaluate project habitability, and many states do not conduct such reviews. Without such information, states are unlikely to detect violations of the Code's habitability requirements.

IRS recently developed a tax credit audit program to assess whether taxpayers were appropriately claiming valid tax credits. However, because the audits conducted were identified through state reports of project noncompliance, the audit program is unlikely to provide sufficient information to estimate overall taxpayer compliance with the tax credit program. IRS is also developing a system to verify that states do not issue more tax credits than they are authorized, but more data on returned credits are needed from the states for the system to accurately verify total state allocations.

Finally, although IRS conducts various tax credit oversight activities, there is no specific requirement or authorization in the Internal Revenue Code for IRS to evaluate state agencies' tax credit operations for compliance with laws and regulations. Unlike other federal housing programs that are generally administered by state agencies, such as the Community Development Block Grant program, the tax credit program is not covered by the Single Audit Act under which state operations are independently audited for compliance with federal laws and regulations.

---

## Principal Findings

---

### Low-Income Housing Tax Credit Projects Vary in Tenant Characteristics, Property Characteristics, and Costs

From its sample, GAO estimates that about 4,100 low-income housing projects containing about 172,000 tax credit supported units were placed in service during the period 1992 through 1994. About an estimated three-quarters of the households had incomes in 1996 that were at or below 50 percent of their area's median income, which the Department of Housing and Urban Development considered to be "very-low income." Also, an estimated 71 percent of the households benefited directly or indirectly from one or more types of housing assistance besides tax credits, such as rental assistance, other government loans, loan subsidies, or grants. For example, about 39 percent of the households received rental assistance, which allowed households that had an average of 25 percent of their area's median income to rent units. Households with rental



---

assistance had an estimated average current income of \$7,860 versus \$16,700 for households without rental assistance.

Tax credit properties placed in service from 1992 through 1994 were located throughout the country. The most common type of property was a walk-up/garden-style apartment building. GAO estimates that the average project contained 43 units, about 73 percent of the projects were newly constructed, and the average monthly rent was about \$435.

GAO estimates that the average cost of developing the units placed in service from 1992 through 1994 was about \$60,000; however, the per unit costs varied substantially. About 10 percent of the units cost less than \$20,000 to develop while about 10 percent cost more than \$100,000. Since tax credits are generally a function of development costs, the cost of these properties to the federal government also varied. GAO estimated the present value of the average tax credit cost per unit over the 10 year tax credit period to be about \$27,300. About 60 percent of the units had tax credit costs at or below the estimated average, and 2 percent had estimated tax credit costs of \$100,000 or more. Costs varied for many possible reasons, such as the types of buildings constructed or rehabilitated, the size and location of the units, and the amount of fees paid to developers.

---

### State Controls for Allocating Credits to Housing Needs Vary

The Internal Revenue Code gives state agencies wide latitude in determining which projects should receive tax credits. The Code requires that states develop qualified allocation plans that target the tax credits to proposed projects that meet their priority housing needs and are appropriate to local conditions. The agencies must also give preference to proposed projects that serve the lowest income tenants and serve qualified tenants for the longest periods. State agencies have defined the tax credit program's requirements in different ways. For example, all state agencies have used 1990 Census data to define their priority housing needs. Some states supplemented these data with more current and detailed data. Similarly, most agencies relied on market studies to define local conditions, but the specificity of the market studies differed among the states. State agencies also used different income levels to define lowest income, and they defined extended-use requirements differently.

The qualified allocation plans generally combined the Code's selection criteria with thresholds, set-asides, points, or rankings to determine which projects were awarded tax credits. According to state allocation agency

officials, these direct controls were often augmented by competition among developers for tax credits. Most of the state agencies reported that they gave preference to project proposals that committed to serving the lowest income tenants by assigning higher scores or bonus points. Similarly, 49 of the 54 state agencies reported giving preference to project proposals with agreements to serve qualified tenants for longer periods of time than the federal law required.

Under the tax credit program, it is up to the states to identify best practices, consider the costs and benefits of alternative approaches, and select the approaches best suited to their conditions. The National Council of State Housing Agencies has a commission examining ways to improve various aspects of the tax credit program, including how allocation plans allocate credits to needs.

Although all states had qualified allocation plans, GAO identified several additional factors that could affect the actual housing delivered over time. First, nearly all of the agencies used discretionary judgement in addition to the criteria in the allocation plans in making final credit allocation decisions. Second, a significant proportion of the tax credits that IRS and state data showed had been allocated could not be reconciled with IRS and state data on the number of tax credits awarded to projects that were placed in service, which may indicate that not all credits allocated have been used. Third, because no tax credit properties have yet reached the end of the 15 year tax credit compliance period, the long-term economic viability of tax credit projects as low-income housing has not been tested. Determining whether, or how, these factors impact the delivery of low-income housing that meets state housing priorities was beyond the scope of this report.

---

### Opportunities for Improving States' Controls Over Project Costs

In order to limit the federal share of housing development project costs, states are to provide no more tax credits to projects than necessary for their financial viability. The Internal Revenue Code provides broad guidance to states for controlling tax credit awards, requiring them to consider the following aspects:

- the reasonableness of a project's development cost;
- the extent of a project's financing gap, which is the difference between the cost of a project and the amount of non-tax credit financing that a project can raise to cover those development costs; and

- the yield obtained from a project's tax credit award, which is the amount of equity investment a project could raise for each tax credit dollar received.

To control the costs to the federal government of individual projects, states are required to evaluate the sources of all financing available to a housing project and the uses to which the financing is to be put. Controlling the amount of tax credits awarded to individual projects limits federal taxpayers' cost for the project and allows a state, with an overall tax credit allocation proportional to its population, to finance more projects.

Consistent with the flexibility given them by the Code, GAO found that states had established controls that varied in their coverage and stringency for helping ensure appropriate tax credit awards. All state agencies had controls over development costs. Many states relied on HUD cost standards, others believed their own standards were more effective in limiting costs, and some relied on their staffs' expertise because they said that differences in project types and location made setting standards impractical. Additionally, most supplemented these practices by using competition among project developers to control costs, i.e., they introduced cost considerations into the ranking systems used to consider projects for tax credit awards. State agency practices for determining the reasonableness of the non-tax credit financing varied, but they generally included reviewing projects' rents and operating expenses, private mortgage terms, and non-tax credit public subsidies. States generally relied on the market to determine the yield obtained from a project's tax credit award.

In controlling costs—that is, in evaluating the reasonableness of project costs, financing gap, and tax credit proceeds—allocating agencies are largely dependent on information submitted by developers. If the agencies do not have complete and reliable information, they are less assured their controls are effective.

GAO found some control weaknesses in terms of the way states used data to evaluate the sources and uses of project funds. For example, although all but one state required some form of independent verification of cost and financing data, the scope of the required cost verification work varied. It ranged from audits that provided an independent public accountant with a reasonable basis for expressing an opinion on the overall reliability of a project's financial information taken as a whole to more limited work,

such as the application of procedures that provided a public accountant with a basis to issue a report of findings based on the procedures agreed to with the state agency but not provide assurances on the reliability of the financial information. Additionally, some of the procedures agreed to by state agencies did not require verification of costs eligible for inclusion in the base for calculating the tax credit. Also, on the basis of the sampled projects, GAO estimates that for about 14 percent of the projects, the states lacked complete information on the sources and uses of project funds. Without assurance of the validity of developer costs and without a complete and documented basis for determining equity needs, such as a detailed sources and uses of funds analysis, states are vulnerable to providing more (or fewer) credits to projects than needed.

As with practices relating to meeting state housing needs, it is up to the states to identify best practices, consider the costs and benefits of alternative approaches, and select the approaches best suited to their conditions. In the area of costs, the National Council of State Housing Agencies has issued some recommended standards and best practices that some states have adopted.

---

## Improvements Can Be Made in State and IRS Oversight Activities

Not all states fulfilled the requirements of their compliance monitoring programs, and, although IRS has been developing oversight programs, it did not have sufficient information to determine overall state or taxpayer compliance. All states reported that they had established compliance monitoring procedures that met the requirements established by IRS. In 1995, however, several states did not do the number of desk reviews and on-site inspections they had agreed to do under IRS regulations. Because IRS' regulations do not require states to submit annual reports to IRS on the number of monitoring inspections made, it was not in a position to readily determine whether states met their agreed-upon monitoring responsibilities.

Also, IRS' monitoring regulations do not require states to make on-site visits to projects or obtain information from other sources, such as local government reports on building code violations, that would allow states to detect violations of the Code's habitability requirements. For IRS to better ensure that habitability problems are identified during monitoring reviews, states would have to do on-site inspections or obtain information on these types of problems from other sources.

GAO found that states were generally sending the reports IRS required on noncompliance found during their monitoring inspections. However, some state agencies expressed concerns about the types of noncompliance that should be reported. In response to state concerns, IRS was revising the noncompliance form states submit so that it lists 10 types of noncompliance that should be reported. GAO found that the proposed form would be more useful for determining whether IRS needed to recapture tax credits from project owners if the form contained data on the number of units out of compliance by type of noncompliance and the date the noncompliance was corrected.

In late 1995, IRS instituted an audit program to determine whether taxpayers are entitled to the credits claimed on their tax returns. IRS is relying on the results of this audit program to provide information on the extent and types of noncompliance that exist in the tax credit program. Without this information, IRS is not in a position to determine how best to allocate resources to tax credit compliance efforts. GAO found that the audit results from IRS' program will not provide statistically reliable compliance data because the audits were selected on the basis of state reports of noncompliance. IRS needs to explore ways to get more reliable data on taxpayer compliance.

IRS is currently developing a document matching program using state tax credit reports to determine whether states have allocated more credits than allowed by law. However, the reports do not contain information on the allocation year of the tax credits that developers returned to the allocating agencies for reallocation to other projects. IRS needs this information in order to determine whether states stay within their tax credit ceilings.

Unlike most programs operated by state and local governments that receive federal financial assistance, the low-income housing tax credit program operations are not subject to independent audits under the Single Audit Act, because tax credits are not considered as federal financial assistance under Office of Management and Budget implementing guidance. However, other state agency operations that receive other types of federal financial assistance, such as Community Development Block Grants, are covered by the Single Audit Act. IRS currently does not have plans to undertake examinations of state agencies' operations and would not do so without congressional direction. Including low-income housing tax credits in the definition of federal financial assistance so that the tax credit program could be subject to the Single Audit Act is one way of

---

promoting state compliance with tax credit laws and regulations. The Code allows state agencies to charge developers fees to cover the administrative costs associated with evaluating project proposals and monitoring projects that are awarded credits. Any additional costs that states may incur could be incorporated into states' administration and monitoring fees.

---

## Recommendations

The low-income housing tax credit program has stimulated low-income housing development in the United States and states' implementation of the allocation process generally meets the requirements of the Internal Revenue Code. However, the procedures that some states and IRS use for review of project proposals and implementation and for oversight of general compliance with laws and regulations should be improved. Accordingly, GAO recommends that the Commissioner of Internal Revenue amend regulations for the tax credit program to (1) establish clear requirements to ensure independent verification of key information on sources and uses of funds submitted to states by developers that form the basis of decisions about the value of tax credits granted for low-income housing projects; (2) require that states report sufficient information about monitoring inspections or reviews, including the number and types of inspections made, so that IRS can determine whether states have complied with their monitoring plans; and (3) require that states' monitoring plans include specific steps that will provide information to permit IRS to more effectively ensure that the Code's habitability requirements are met. GAO also recommends that the Commissioner explore alternative ways to obtain better information to verify that states' allocations do not exceed tax credit authorizations and to evaluate taxpayers' and housing projects' compliance with the requirements of the Code.

Finally, to help ensure appropriate oversight of state allocating agencies' overall compliance with tax credit laws and regulations, GAO recommends that the Director, Office of Management and Budget, incorporate the low-income housing tax credit program in the definition of federal financial assistance included in implementing guidance for the Single Audit Act, as amended, so that the program would be subject to audits conducted under the Single Audit Act.

---

## Federal Agency and State Association Comments

GAO received written comments on a draft of this report from IRS and the National Council of State Housing Agencies and oral comments from the

Office of Management and Budget. IRS agreed with the recommendations and, separately, orally advised GAO that it had started to implement them.

OMB advised GAO that it did not take exception to strengthening accountability over the low-income housing tax credit program by building on an existing accountability mechanism such as the single audit concept. However, OMB said that incorporating the low-income housing tax credit in the definition of federal financial assistance included in implementing guidance for the Single Audit Act would likely require a broader evaluation of accountability for tax credit programs in general, and the application of the single audit concept in particular. Also, OMB indicated that any changes in tax credit accountability might be more appropriately accomplished through legislation than administrative initiative.

GAO does not object to OMB's premise about an approach for considering how to make the low-income housing tax credit program subject to audits conducted under the Single Audit Act. GAO also notes that an evaluation along the lines suggested by OMB could also include an assessment of whether and, if so, what legislation might be most appropriate.

In commenting on this report, the National Council of State Housing Agencies noted that while it had previously expressed concerns about potential bias and prejudice in some aspects of GAO's work, the report answered many of those concerns. Nonetheless, the Council had a number of comments. These comments are discussed at the end of the appropriate chapters. Principal among the comments are the following five.

- First, the Council said that the report “vindicates public predictions by GAO officials that nothing in the report could justify Housing Credit repeal.” In response, GAO emphasizes that it has never taken a position on whether the tax credit should be retained or repealed. Further, GAO notes that its work focused on controls established by IRS and the states in implementing tax credit requirements and that making judgments as to the merits of the tax credit program was not part of that work.
- Second, the Council indicated that the report also addresses some of its concerns in that the report documents how the credit is “exceeding” its objectives and cited as evidence a number of income, rent and cost estimates in the report. Contrary to the Council's interpretation, GAO did not take a position on whether the tax credit program is exceeding its objectives and notes that some results cited by the Council were attributed in the report to the use of other government subsidies, such as federal rental assistance programs, in combination with tax credits.

- Third, the Council expressed concerns because the report implies that state deviations from Council-recommended best practices are deficiencies. GAO disagrees and notes that the report repeatedly points out that the states were given flexibility in the administration of the program. The report clearly makes the point that state agencies have no legal requirement to follow Council-recommended best practices, such as making site visits. GAO's recommendations were based on Internal Revenue Code requirements and were developed with the intent of better positioning IRS to carry out its responsibilities for assuring compliance.
- Fourth, the Council said GAO's sample was arbitrary because it includes all large housing projects. GAO strongly disagrees with this characterization and rationale. GAO oversampled large projects in order to reduce sampling error. GAO produced estimates from this sample using a standard statistical technique that compensates for the oversampling by weighting each sample project by its population weight. This statistical technique is commonly used and statisticians have shown it produces unbiased estimates. Using this technique, GAO was able to reduce the size and cost of the sample while maintaining an adequate level of statistical precision for both project and housing unit estimates.
- Fifth, the Council stated that some of GAO's recommendations do not take into account their cost effectiveness. GAO recognizes that costs associated with implementing its recommendations should always be a concern and states that it developed its recommendations with that in mind. For example, in recommending that the Single Audit Act be used to strengthen federal oversight of the tax credit program, GAO notes that the act was established to eliminate potentially duplicative and burdensome federal oversight reviews. Similarly, in recommending that IRS establish requirements for ensuring independent verification of information on sources and uses of funds, GAO considered a range of options and estimated costs for obtaining such verifications.



---

---

---

# Contents

---

<b>Executive Summary</b>		2
<b>Chapter 1</b>		22
<b>Introduction</b>	Background	22
	Transferring Tax Credits From the Federal Government to the Private Sector	23
	Overseeing Compliance With the Tax Credit Program's Requirements	28
	Objectives, Scope, and Methodology	31
	State Association Comments and Our Evaluation	35
<b>Chapter 2</b>		37
<b>Low-Income Housing Tax Credit Properties: Their Residents, Characteristics, and Costs</b>	Reported Incomes for Most Tax Credit Households Were Very Low	38
	Tax Credit Households Were Generally Small and Projects Had Diverse Resident Populations	42
	Properties Were Widespread, Units Were Generally Small, and Rents Were Restricted	43
	Tax Credit and Development Costs Varied Widely	47
	Observations	52
	State Association Comments and Our Evaluation	52
<b>Chapter 3</b>		54
<b>States' Controls for Allocating Credits to Housing Needs Vary</b>	Internal Revenue Code Gives Agencies Wide Latitude in Allocating Tax Credits	54
	Agencies Have Defined the Program's Requirements in Different Ways	55
	Allocation Plans Weight Selection Criteria	62
	Allocation Plans Provided for Targeting Tax Credits	63
	Several Factors May Affect the Housing Actually Delivered Over Time	68
	Conclusions	71

<b>Chapter 4</b>		73
<b>Opportunities for Improving States' Controls Over Project Costs</b>	Tax Code Requirements	73
	Allocating Agency Practices for Ensuring Reasonable Development Costs	76
	Allocating Agency Practices for Determining Project Equity Needs	83
	State Controls Over Tax Credit Pricing	88
	Effectiveness of Cost Controls Depends on Accuracy of Cost Data	91
	Conclusion	93
	Recommendation to the Commissioner of Internal Revenue	95
	Federal Agency and State Association Comments and Our Evaluation	95
<hr/>		
<b>Chapter 5</b>		96
<b>Opportunities Exist to Improve State and Federal Compliance Oversight Activities</b>	Opportunities to Improve State Oversight	99
	Opportunities to Improve IRS' Oversight Activities	108
	Little Independent Oversight of State Housing Agencies' Operations	113
	Conclusions	117
	Recommendations to the Commissioner of Internal Revenue and Director, Office of Management and Budget	119
	Federal Agency and State Association Comments and Our Evaluation	119
<hr/>		
<b>Appendixes</b>	Appendix I: Statistical Methodology for Evaluating the Low-Income Housing Tax Credit Program	122
	Appendix II: Additional Data on Incomes of Tax Credit Households by Type of Other Housing Assistance Received	145
	Appendix III: Tax Credit Project Information Reported by Allocating Agencies and Used in the GAO Sample	148
	Appendix IV: Results of Site Visits to GAO Sample Properties	153
	Appendix V: Comments From the Internal Revenue Service	170
	Appendix VI: Comments From the National Council of State Housing Agencies	171
	Appendix VII: Major Contributors to This Report	175
<hr/>		
<b>Tables</b>	Table 2.1: Estimated 1996 Incomes of Households With and Without Additional Rental Assistance Residing in Tax Credit Properties Placed in Service, 1992-94	41

Table 3.1: Tax Credits Awarded to Projects Placed in Service, 1992-94	69
Table 4.1: Size of Mortgage Deemed Supportable Under Alternative Debt Service Coverage Ratios and Amortization Periods	85
Table 4.2: Estimated Sources of Financing for Projects Requiring Subsidies in Addition to Tax Credits	87
Table 4.3: Estimated Distribution of Equity Prices Received for Properties Placed In Service, 1992-1994	90
Table 5.1: Number of State Agencies That Either Met, Exceeded, or Failed to Meet IRS' Monitoring Requirements in 1995	101
Table 5.2: Number of State Agencies That Either Fully Met, Partially Met, or Did Not Meet NCSHA's Monitoring Guidelines in 1995	102
Table 5.3: Estimates on the Types of Noncompliance Identified by Desk Reviews and On-Site Inspections That Found At Least One Incident of Noncompliance	103
Table 5.4: Number of Form 8823s Submitted by State Agencies to IRS in 1995	105
Table I.1: Sampling Errors of Estimates From Information in the Project Questionnaire	126
Table I.2: Sampling Errors of Estimates About the Households Occupying LIHTC Units	135
Table I.3: Sampling Errors for Table 2.1—Economic Data on Low-Income Households With and Without Additional Rental Assistance	141
Table I.4: Sampling Errors for Income Data on Low-Income Households by Type of Housing Assistance Provided	142
Table I.5: Sampling Errors for Table 2.1—Current Incomes by Type of Qualifying Household Reported by Property Managers in 1996 (Properties Placed in Service 1992 Through 1994)	143
Table I.6: Sampling Errors for the Ratio of Household Current Income to Applicable Area Median Income by Type of Qualifying Household—Properties Placed in Service 1992-1994	143
Table I.7: Sampling Errors for Table 5.3—Types of Noncompliance Found By Desk Review and On-Site Inspections	144
Table I.8: Sampling Errors for Table 4.2—Sources of Financing for Projects Requiring Subsidies in Addition to Tax Credits	144
Table II.1: Income Estimates for Households Residing in Tax Credit Properties Placed in Service, 1992-94, by Type of Housing Assistance Provided	146

Table II.2: Current Income Estimates by Type of Qualifying Household Reported by Property Managers in 1996 for Properties Placed in Service, 1992-94	147
Table II.3: Ratio of Household Current Income Estimates to Applicable Area Median Income by Type of Qualifying Household for Properties Placed in Service, 1992-94	147
Table III.1: Summary of Tax Credit Projects Reported to GAO by Tax Credit Allocating Agencies as Placed in Service During the Period 1992-1994	149
Table III.2: Summary of GAO Sample of Tax Credit Projects Reported to GAO by Tax Credit Allocating Agencies as Placed in Service During the Period 1992—1994	150

## Figures

Figure 1.1: Transferring Tax Credits From the Federal Government to the Private Sector	24
Figure 1.2: Tax Credit Oversight System	29
Figure 2.1: Estimated 1996 Incomes of Households in Tax Credit Units	39
Figure 2.2: Estimated 1996 Incomes of Households in Tax Credit Units Relative to Applicable Area Median Income	40
Figure 2.3: Estimated Size of Households in Tax Credit Properties Placed in Service, 1992-94	42
Figure 2.4: Location Estimates for Tax Credit Properties and Units Placed in Service, 1992-94	44
Figure 2.5: Estimated Average Per-Unit 10 Year Tax Credit Costs of Properties Placed in Service, 1992-94	48
Figure 2.6: Estimated Average Per-Unit Development Costs of Tax Credit Properties Placed in Service, 1992-94	49
Figure 2.7: Estimated Average Per-Unit Costs of Properties Placed in Service, 1992-94, By Type of Construction, Location, and Building	51
Figure 4.1: Estimates on Housing Project Sources and Uses of Funds	76
Figure 5.1: Tax Form Flow and Oversight	97
Figure IV.1: Castle Square, Boston, MA	154
Figure IV.2: Turk Street Apartments, San Francisco, CA	155
Figure IV.3: Mount Mercy, Grand Rapids, MI	156
Figure IV.4: Graham/Terry, Seattle WA	157
Figure IV.5: Providence Square, New Brunswick, NJ	158
Figure IV.6: O'Hern House, Atlanta, GA	159
Figure IV.7: Cascade Commons, Sterling, VA	161

---

**Contents**

---

Figure IV.8: Rancho Del Mar, Tucson, AZ	162
Figure IV.9: Covington Court, St. Paul, MN	163
Figure IV.10: Lakewood Terrace, Lakeland, FL	164
Figure IV.11: Mansfield Manor, Mansfield, TX	165
Figure IV.12: Lake Pointe, Conway, AR	166
Figure IV.13: Post Glen, Oceana, WV	167
Figure IV.14: Edgewood, Belton, SC	168
Figure IV.15: Hardwick, Hardwick VT	169

---

**Abbreviations**

CDBG	Community Development Block Grant
DHCR	Division of Housing and Community Renewal
DHR	Division of Housing and Community Renewal, New York State
FMFIA	Federal Managers' Financial Integrity Act
HUD	Department of Housing and Urban Development
IRS	Internal Revenue Service
NCSHA	National Council of State Housing Agencies
OMB	Office of Management and Budget
RHS	Rural Housing Service

---

---

# Introduction

---

In the Tax Reform Act of 1986, Congress replaced existing tax incentives for construction of low-income housing, such as accelerated depreciation, with tax credits to encourage the development of affordable rental housing for low-income households. To control the use of the tax credits and ensure the delivery of affordable housing to low-income households, Congress established a joint federal/state program for transferring federal tax credits to the private sector.

This report responds to a request from the Chairman, House Committee on Ways and Means, that we determine the characteristics of low-income housing tax credit projects and assess the controls established by the Internal Revenue Service (IRS) and the states for implementing the requirements of the Low-Income Housing Tax Credit program. These controls are to ensure that (1) state priority housing needs are met; (2) housing project costs, including tax credit costs, are reasonable; and (3) states and project owners comply with program requirements.

---

## Background

In establishing the tax credit incentive, Congress recognized that a private sector developer may not receive enough rental income from a low-income housing project to (1) cover the costs of developing and operating the project, and (2) provide a return to investors sufficient to attract the equity investment needed for development. To spur investment, Congress authorized the states, within specified limits, to allocate tax credits to qualifying housing projects. The credits may then be shared among the owners of a project (equity investors), much as income and losses are shared among business partners for tax purposes. Generally, the investors are recruited by syndicators, and ownership rights are controlled by limited partnership agreements.

Under the Internal Revenue Code, the amount of tax credits that states through their tax credit allocating agencies may award to housing projects are limited. The maximum tax credit allowed per year depends on the type of project, but in many cases it is about 9 percent of a newly constructed project's qualified basis, which is generally equal to the development costs allocated to low-income units, less the land and certain other costs. The amount of the credit award may be claimed annually on the tax returns of the project owners (individuals and corporations) for 10 years, provided that the projects remain in compliance with the tax credit program rules.

Under the Code, the amount of tax credits available to the state tax credit allocating agencies are also limited. In general, each year the states receive



an additional allotment of about \$300 million in tax credits to award to new low-income housing projects. Assuming project owners remain eligible, they would be entitled to take the \$300 million in tax credits each year for 10 years. Thus, in any one year, 10 years worth of federal tax credits would be outstanding and the aggregate annual cost to the federal government would be \$3 billion.

At the initiation of our work, no comprehensive data were available on the dollar amount of the tax credits that had been awarded to housing projects since the program began in 1987. In querying the tax credit allocating agencies, we were advised that about 4,200 projects with about 175,600 units were placed in service in the continental United States during the period 1992 through 1994. After accounting for misreporting by the allocating agencies, which we identified during our review of 423 sampled projects (see apps. I,II and III), we estimate that about 4,100 projects containing about 172,000 tax qualified units were placed in service in the continental United States during the period 1992 through 1994. We also estimate that, for these projects, the states annually awarded tax credits with a potential value over their 10-year lifetime of about \$2 billion (about \$1.6 billion in present value terms), or about \$6.1 billion for the three years combined. These estimates constitute the universe of projects discussed in this report.

---

## **Transferring Tax Credits From the Federal Government to the Private Sector**

To manage the transfer of federal tax credits to the private sector, Congress established a multistep federal/state process, which is depicted in figure 1.1 and described in the accompanying narrative.

Figure 1.1: Transferring Tax Credits From the Federal Government to the Private Sector

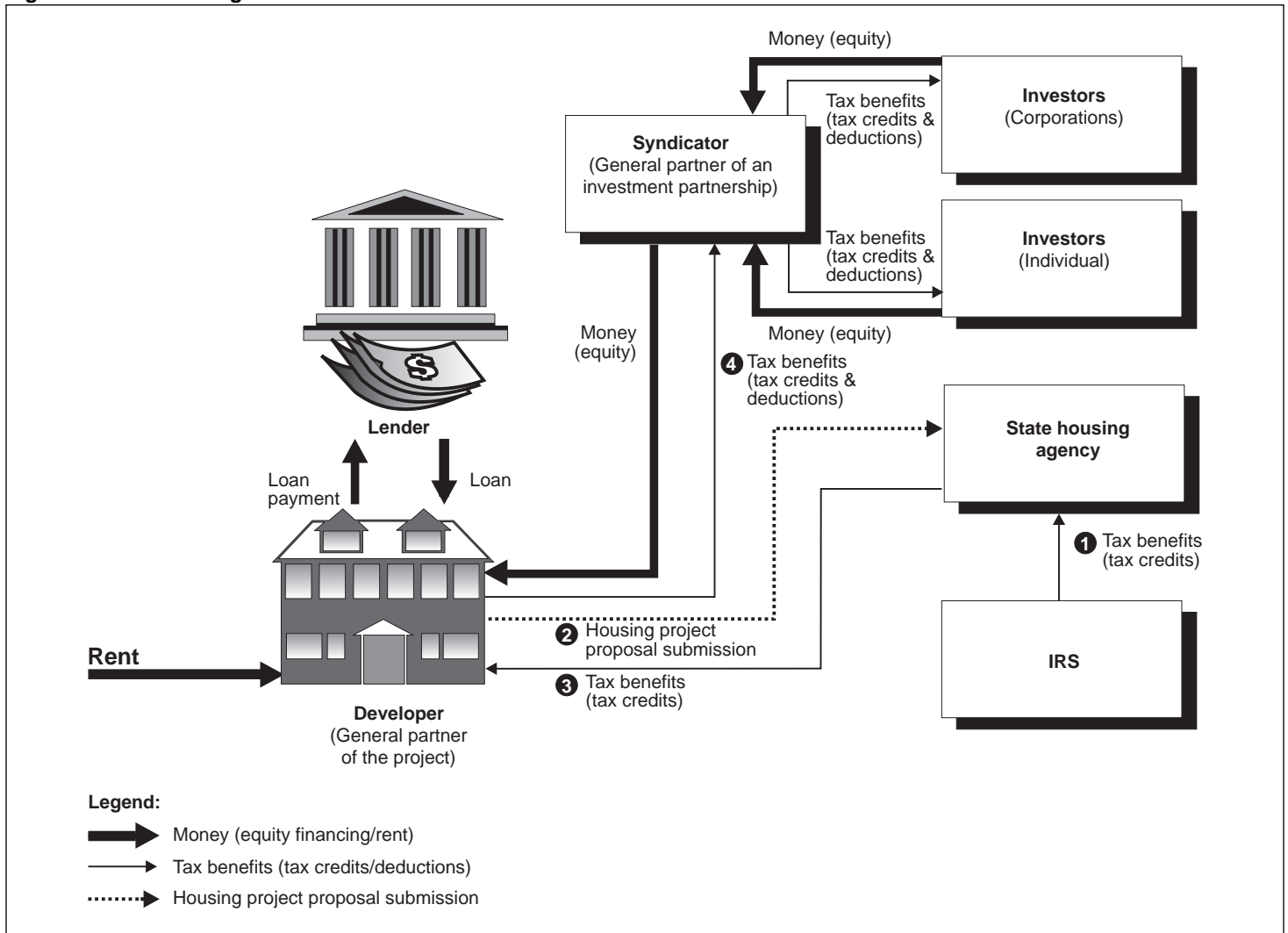

Source: GAO's discussions with IRS and state agency officials, syndicators, developers, and investors.

**(1) IRS Apportions Tax Credits to the Allocating Agencies:** The Internal Revenue Code directs IRS to provide the tax credit allocating agencies with information each year for computing the tax credits

available to them for allocation.<sup>1</sup> In general, the allocation is limited to \$1.25 per state resident, a portion of the unused tax credits returned to IRS by other states, unused credits from the prior year, and credits initially allocated in previous years and returned in the current year.<sup>2</sup> The allocating agencies have up to 2 years to award the credits to housing projects; after that time, they must return any unused credits to IRS for reassignment to other states. When the credits have been awarded, they are usually available to the owners/investors annually for a 10-year period as long as the project meets the Code's requirements.

**(2) Developers Apply to the Allocating Agencies for Tax Credits:** To apply for tax credits, a developer must submit a detailed proposal to an allocating agency. The proposal must describe the housing project, indicate how much it will cost, and identify the sources and uses of the funds available to finance the project's development and operations. In describing the project, the developer must identify the total number of units and the number of units expected to qualify for tax credits. To qualify for consideration, a project must

- reserve either at least 20 percent of the available units for households earning up to 50 percent of the area's median gross income adjusted for family size or at least 40 percent of the units for households earning up to 60 percent of the area's median gross income adjusted for family size,
- restrict the rents (including the utility charges) for tenants in low-income units to 30 percent of an imputed income limitation based on the number of bedrooms in the unit,
- meet habitability standards, and
- operate under the program's rent and income restrictions for 15 years for projects placed in service before 1990 and for up to 30 years for later projects.<sup>3</sup>

---

<sup>1</sup>State and local housing agencies are specifically authorized by gubernatorial act or state statute to make housing credit allocations on behalf of the state or political subdivision and to carry out the low-income housing tax credit provision.

<sup>2</sup>The annual state credit volume ceiling does not cover tax credits issued for low-income housing projects financed by at least 50 percent in tax-exempt multifamily housing bonds. These bonds are subject to annual state-by-state caps on the volume of private activity bonds.

<sup>3</sup>In 1989, Congress amended the low-income housing tax credit provisions in response to concerns that tax credit properties, like properties developed under earlier federal housing programs, would be converted to market-rate housing at the first opportunity. One amendment extended the requirement for tax credit properties to serve low-income tenants from 15 years to 30 years. However, the amendment included a provision that left open the possibility of conversion to market rates after 15 years. In the event of a property's conversion, the new owner(s) could evict the low-income tenants after 3 years. In effect, the amendment guaranteed that tax credit units could remain in an allocating agency's low-income housing inventory for 3 more years, up to 18 years. Nevertheless, the amendment also emphasized that more stringent requirements, whether included in the agreement between the developer and the allocating agency or imposed by state law, would override the federal law.

**(3) Allocating Agencies Award Tax Credits to Selected Housing Projects:** The allocating agencies are responsible for (1) awarding their tax credits to qualifying projects that meet their state's qualified allocation plans and (2) controlling the value of the tax credits awarded to projects.

To select developers' proposals for tax credit awards, an allocating agency is required to evaluate the proposed projects against a qualified allocation plan developed in accordance with the Code's requirements. The qualified allocation plan must establish a procedure for ranking the projects on the basis of how well they meet the state's identified housing priorities and meet selection criteria that are appropriate to local conditions. In addition, the plan must give preference to projects that serve the lowest income tenants and serve qualifying tenants for the longest period of time.

In awarding tax credits to a project, an allocating agency is to provide no more credits than it deems necessary to ensure the project's financial feasibility throughout the 15 year tax credit compliance period. An allocating agency must consider any proceeds or receipts expected to be generated through tax benefits, the percentage of housing credit dollar amounts used for projects costs other than the cost of intermediaries, and the reasonableness of developmental and operational costs. In general, the agency is to compare the proposed project's development costs with the non-tax credit financing, both private and governmental. The difference between the development costs and the non-tax credit financing is the financing gap. Tax credits are used, up to a ceiling, to attract the equity investment needed to fill the gap.

The ceiling on tax credits limits the present value of the 10-year stream of tax benefits to no more than (1) 70 percent of the qualified basis for new construction or substantial rehabilitation or (2) 30 percent of the qualified basis of acquired buildings that are substantially rehabilitated. To qualify as "substantial rehabilitation," the rehabilitation expenditures must equal at least 10 percent of the building's cost or at least \$3,000 per low-income unit, whichever is greater. For buildings placed in service in 1987, the 70-percent and 30-percent ceilings were equivalent to an annual tax credit rate of 9 percent and 4 percent, respectively. Since 1987, Treasury has

adjusted the annual credit rate monthly to maintain the present value of the credit at 70 percent or 30 percent.<sup>4</sup>

In general, the qualified basis is the portion of a project's total costs—excluding the costs of land, obtaining permanent financing, rent reserves, syndication, and marketing—that is allocable to low-income units that meet the Code's requirements for rent, tenants' income, and habitability. Costs can include the cost of the residential rental units and facilities for use by the tenants or required for the project, such as parking areas and trash disposal equipment.

Low-income housing tax credit projects that use federal subsidies generally receive a smaller credit. If federally subsidized loans are used to finance substantial rehabilitation or new construction, either the eligible basis of the building must be reduced or the 30 percent credit must be used. Federally subsidized loans include below-market federal loans and tax-exempt financing. There are exceptions for certain kinds of federal funds, including Community Development Block Grant (CDBG) funds and certain projects receiving assistance under the HOME Investment Partnership Act. Additionally, basis must be reduced by the amount of a federal grant provided to a project during the 15 year compliance period.

The Code requires an allocating agency to conduct an evaluation of the financial gap that considers the available private financing, plus all of the federal, state, and local subsidies a developer plans to use. This evaluation helps the agency determine the value of a project's tax credit award. Although the maximum tax credit award is generally about 9 percent of a newly constructed or substantially rehabilitated project's qualified basis, the maximum award may be reduced to 4 percent when a project's financing combines federally subsidized loans with the tax credit.

**(4) Tax Benefits Provide a Return on Equity Investments:**

Syndicators (investment partnerships) are a primary source of equity financing for tax credit projects. They recruit investors who are willing to become partners (generally, limited partners) in housing projects that, because of rent restrictions, are generally not expected to return rental profits to investors.<sup>5</sup> Rather, the investors expect, for 10 years, to receive

---

<sup>4</sup>The basis used in calculating the tax credit award may be increased by up to 30 percent for new construction or substantial rehabilitation in a qualified Census tract or "difficult development area." In a qualified Census tract, 50 percent or more of the households have incomes of less than 60 percent of the area's median income. In a difficult development area, construction, land, and utility costs are high relative to the area's median income.

<sup>5</sup>Individuals and businesses may also invest directly in tax credit housing projects.

tax credits and other tax benefits, such as business loss deductions, that they can use to offset the taxes they owe on other income. These tax benefits (plus the possibility of cash proceeds from the sale of the project) represent the return on investment. The value of the tax benefits may vary from year to year, since the value of the tax credit depends on the number of habitable, rent-restricted units occupied by qualifying low-income households.

---

## Overseeing Compliance With the Tax Credit Program's Requirements

To promote compliance with the tax credit program's requirements, the Internal Revenue Code establishes a joint federal/state oversight system. In summary, the states are the governmental entities responsible for determining whether housing projects qualify for tax credits, allocating credits to qualifying projects, and overseeing the compliance by the selected projects with the program's restrictions on rents and residents' incomes and on standards for habitability. IRS is the governmental entity responsible for ensuring that the states allocate no more tax credits than they are authorized to allocate and that taxpayers claim no more tax credits than they are entitled to claim. To facilitate the federal government's oversight, the states are required to report annually to IRS their total tax credit allocation to proposed projects, the tax credit awarded to each building in the project upon its being placed in service, and any instances of noncompliance. Additionally, the private sector (both investors and lenders) has an interest in overseeing the viability of the housing projects and their continuing eligibility for tax credits.

This system, depicted in figure 1.2, is supplemented by the private sector's oversight.

Figure 1.2: Tax Credit Oversight System

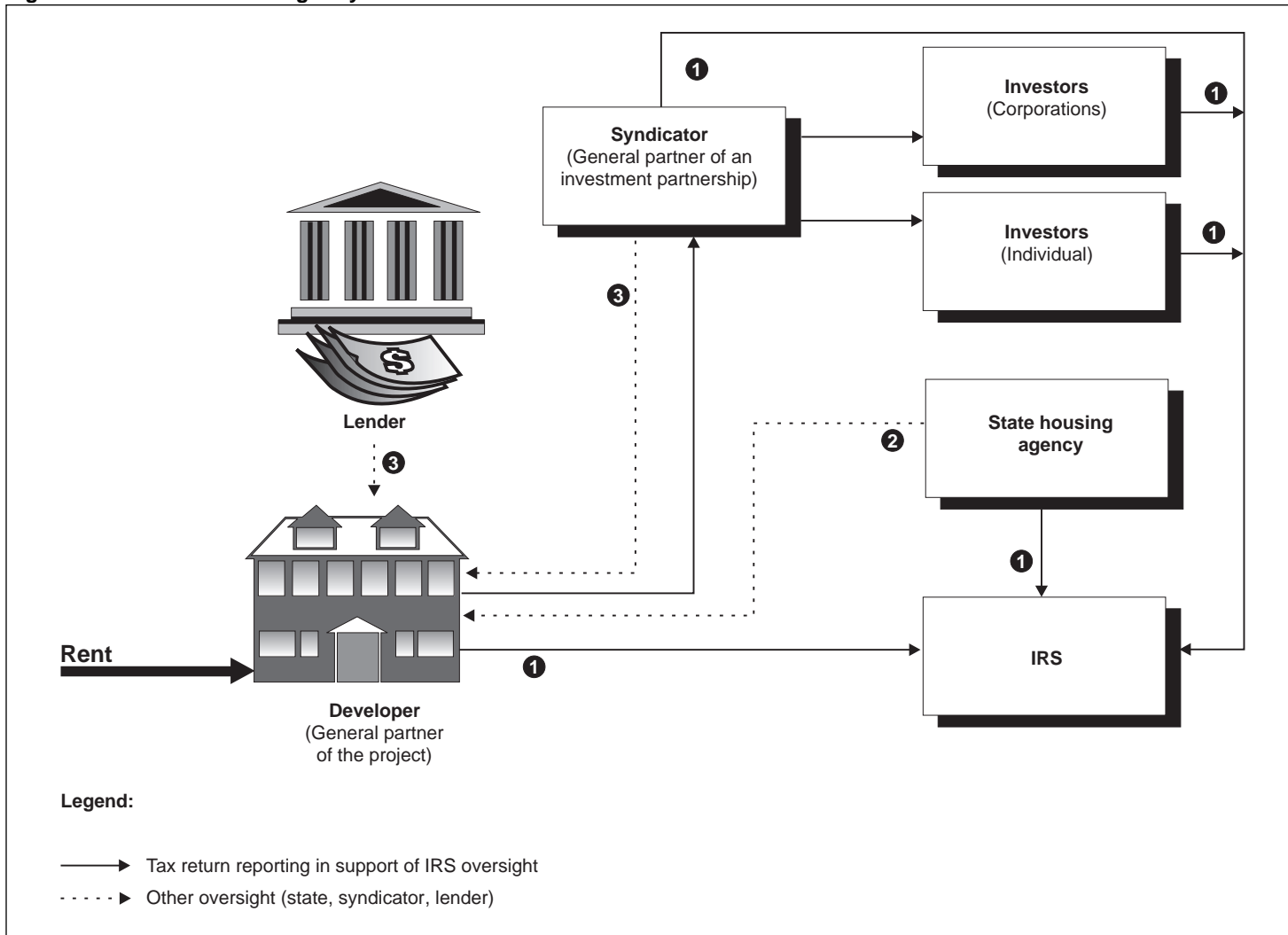

Source: GAO's discussions with IRS and state agency officials, syndicators, developers, and investors.

**(1) IRS Is Responsible for Overseeing Compliance:** IRS has the authority to take actions—such as issuing regulations, requiring reporting, and initiating audits—to ensure that the states and taxpayers use no more tax credits than authorized. Under this authority, IRS requires annual reports from the states on their total tax credit allocations to proposed

projects and on their awards to individual projects when these projects are placed in service. The purpose of these reports, together with tax returns,<sup>6</sup> is to provide IRS with the data it needs to oversee participants' compliance. Project owners must certify annually that the project has continuously complied with the threshold low-income targeting requirements.

**(2) Allocating Agencies Are Responsible for Overseeing Projects' Operations:** The states are responsible for monitoring compliance with restrictions on rents and tenants' income as well as with standards of habitability. The state is to notify IRS of any violations of these three requirements. Such violations could result in the loss of all or a portion of a project's tax credits for the years of noncompliance and the recapture of up to one-third of the tax credits claimed for prior years.<sup>7</sup>

**(3) Investors and Lenders Have an Interest in Oversight:** Investors (usually led by a syndicator) and lenders may help IRS and states to oversee tax credit housing projects. To ensure that investors receive their full complement of tax credits over the designated period, investment groups have an interest in monitoring compliance at housing projects. Similarly, to ensure that loans are repaid, lenders have an interest in overseeing the finances of the housing projects. Assessing the extent of the private sector's oversight was not part of this review.

---

<sup>6</sup>At tax year-end, with the filing of tax returns, building owner partnerships are to apportion income or losses and tax credits among the partners (investors) relative to their shares of the investment. Both the investors and IRS are to be notified of the amounts via a schedule attached to the partnership's tax return. This return is to be filed with IRS and copies are to be sent to the investors. Since there may be multiple partnerships (e.g., an investment partnership investing in another investment partnership) between the building owner partnership and the taxpayers (individual and corporate investors), the apportionment process may be repeated a number of times. Investors (corporations or individuals), after receiving the apportionment, are responsible for including those amounts in their tax returns. But, because of the Internal Revenue Code's passive-loss restriction rules, individuals are generally limited to using tax credits and loss deductions from rental real estate activities to offset no more than \$25,000 of income from sources such as wages and business activities. For a taxpayer in the 28 percent tax bracket, this is equivalent to a credit of about \$7,000. Also, individuals and corporations are subject to Alternative Minimum Tax rules and may not use the credit to reduce the Alternative Minimum Tax.

<sup>7</sup>The tax credits, although they can be claimed on tax returns over a 10-year period, are contingent on a housing project's complying for 15 years with the program's standards for habitability and restrictions on households' incomes and units' rents. In effect, the tax credits that would normally be earned on the basis of a housing project's performance during years 11 through 15 may be taken by taxpayers on a prorated basis during the first 10 years of the housing project's operations, i.e., one-third of the credits available in years 1 to 10 relate to credits that may be earned in years 11 through 15. To deal with instances of noncompliance, the Code provides not only for the loss of all credits for the tax year of noncompliance but also for the recapture of the advance paid portion of the tax credits related to the noncompliant units.



---

## Objectives, Scope, and Methodology

The Chairman, House Committee on Ways and Means, asked us to study the controls established by the states and IRS for implementing the tax credit program's requirements. Specifically, this report discusses the characteristics of the residents of projects placed in service from 1992 through 1994 and the characteristics of these projects themselves. The report also assesses the states' and IRS' controls for ensuring that

- tax credits are allocated to proposed housing projects that meet the states' identified priority housing needs, meet selection criteria that are appropriate to local conditions, and serve the lowest income households and serve qualifying households for the longest period of time;
- project costs, including tax credit costs, are reasonable so that no more tax credits are awarded than are necessary to ensure the financial viability of the housing projects; and
- states comply with program requirements and project owners comply with the federal tax laws for both maintaining habitable rent- and income-restricted buildings and correctly reporting tax credits on their annual tax returns.

This report does not assess the efficiency of tax credits relative to other types of housing assistance for low-income households, such as CDBG loans, HOME Investment Partnership loans, Rural Housing Service (RHS) mortgages, and Section 8 certificates and vouchers.<sup>8</sup> Such a study would have to account for several other factors including benefits and costs of the alternatives, oversight, and budgetary outlays.

Given the decentralized administration of, and lack of centralized data, on the tax credit program, our approach relied heavily on standardized data collection. To develop descriptive information on the program's requirements, activities, and results, we worked with the National Council of State Housing Agencies (NCSHA)<sup>9</sup> and 54 tax credit allocating agencies, which included 50 state agencies, the District of Columbia, 2 suballocating agencies in New York state, and a suballocating agency in Chicago. We also worked with the allocating agencies in the continental United States to compile an inventory of housing projects that were placed in service from 1992 through 1994. We selected this period because state monitoring requirements did not go into effect until 1992, and 1994 was the latest year

---

<sup>8</sup>These programs are discussed in chapter 2.

<sup>9</sup>NCSHA is a national, nonprofit organization created in 1970 to assist state housing agencies in advancing the interest of lower-income people through the financing, development, and preservation of affordable housing. NCSHA's members operate in every state and the District of Columbia, Puerto Rico, and the U.S. Virgin Islands.

that states had complete information on projects placed in service at the time we requested information from them. For the continental United States, the state reported data showed that about 4,200 tax credit projects (containing about 175,600 tax credit supported units) were placed in service from 1992 to 1994.

From the project universe data, we selected a stratified random sample of 423 projects containing nearly 50,000 units.<sup>10</sup> The project universe was broken into two strata (large and small projects). All large projects, which consisted of projects with 300 or more tax credit units, were included in the sample. The projects in the small strata were drawn with a probability proportional to the number of units in the projects. The sample was designed to produce statistically sound estimates of the characteristics of projects placed in service nationwide during the 3-year period. The samples from individual agencies are, however, too small to yield reliable estimates of the characteristics of projects from any one state.

This data collection effort helped us determine how the agencies awarded tax credits in calendar years 1992 through 1994, as well as obtain descriptive information—not previously available—on the projects' costs and financing. More specifically, after accounting for misreporting by the allocating agencies, which we identified during our review of 423 sampled projects (see apps. I,II and III), we estimate that 4,121 projects containing 172,151 tax qualified units were placed in service in the continental United States during the period 1992 through 1994. We also estimate that, for these projects, the allocating agencies annually awarded tax credits with a potential value over their 10-year lifetime of about \$2 billion (about \$1.6 billion in present value terms), or about \$6.1 billion for the three years combined.<sup>11</sup> These estimates constitute the universe of projects discussed in this report.

We developed and mailed two questionnaires—one project questionnaire and one state agency questionnaire—to state allocating agencies and one project manager questionnaire to project managers. We followed up with visits to selected agencies and housing projects and reviews of housing project files maintained by the selected agencies. We developed instruments to standardize the collection of data from these disparate sources and, because much of the information was supplied by the

---

<sup>10</sup>We excluded Alaska and Hawaii projects from our sample since, because of cost considerations, we would have been unable to visit these states to verify project data.

<sup>11</sup>The discount rate used was 6.7 percent, the average interest rate on U.S. Treasury Securities with a 10 year constant maturity for the period 1992 through 1994.

allocating agencies or project managers, developed procedures to test the reliability of the information.

To ensure that data collection was consistent, we pretested the questionnaires with state housing agency officials in three states and property managers in one state and the District of Columbia. In addition, the questionnaires were reviewed by two panels of housing and tax experts convened by NCSHA. Guided by the results of the pretest and expert reviews, we revised the questionnaires to ensure that the questions were fair, relevant, and understandable.

Appendix I contains a technical description of our sampling methodologies and discusses the statistical precision of the estimates derived from our samples.

---

## **Characteristics of Projects and Their Tenants**

To determine the characteristics of low-income housing tax credit projects, we used data from the project-specific questionnaire dealing with project size, type, location, development and tax credit costs, and non-tax credit financing. During our visits to 44 state agencies, we verified selected data for 407 of the 423 projects using documents available in the agencies' project files. For the 10 agencies not visited, we requested backup documentation to facilitate a desk review of the responses for the remaining 16 projects.

To determine the characteristics of project tenants, we used data from the project manager questionnaire, which contained information on tenants' rents, income, and household size. We judgmentally selected, on the basis of cost considerations, a subsample of 92 projects to visit to more fully validate their conditions and operations. To verify our information on tenant income, we selected a random sample of at least one tenant in each of the sampled projects. We reviewed IRS tax return data on the tenants in the sample to determine whether the current income of these tenants met the program's income restrictions.

---

## **Allocating Credits to Meet State Priority Housing Needs**

To determine whether state agencies had established controls for appropriately allocating credits to state needs, we used data from the state agency questionnaire that was designed, in part, to identify and evaluate state allocating agencies' policies, procedures, and controls for ensuring that tax credit allocations satisfy the program's requirements. We mailed this questionnaire to 54 tax credit allocating agencies, and we made

follow-up visits to 44 agencies to review the responses. During these reviews, we traced selected responses to source documents, such as state regulations and policies. From the 10 agencies that we did not visit, we requested key source documents to facilitate our review of each agency's operations. We received these documents from nine of the agencies; the tenth agency responded to our request for data too late for us to verify the information. In addition, we judgmentally selected and reviewed in detail the qualified allocation plans for 1995 from 20 agencies. These agencies allocate 65 percent of the program's tax credits; however, the results of our reviews of these plans cannot be generalized to all of the plans from the 54 agencies. Finally, we examined the consolidated plans for a number of states. The Department of Housing and Urban Development (HUD) requires the states to develop these plans to identify and rank their housing needs.

---

### **The Reasonableness of Project Costs and Tax Credits**

To evaluate the controls state agencies used to determine the reasonableness of project costs and tax credit awards, we analyzed the data the agencies reported on both the project-specific and state agency questionnaires. From the project questionnaire, we analyzed data on project costs, financing, and tax credit awards. We also reviewed the cost certifications used by allocating agencies to validate the costs for a subsample of 48 projects to determine the adequacy of these certifications.

From the state agency questionnaire, we analyzed data on agencies' policies, procedures, and practices for evaluating project development costs, project equity needs, and tax credit pricing determinations.

---

### **State and IRS Oversight Activities**

To evaluate state oversight activities, we analyzed data from both the project and state agency questionnaires that related to the states' monitoring policies, procedures, and practices. In collecting data from the state agencies, we asked the agencies whether third-party audits had been conducted on their operations. We also reviewed two audit reports, both completed in 1996, on the operations of the tax credit program in Texas and in New York State.

To evaluate IRS' oversight activities, we examined IRS' automated systems to determine whether they are able to identify instances in which (1) agencies overallocate their tax credits or (2) taxpayers claim credits that they were not entitled to take. As part of this work, we documented relevant IRS policies and procedures; discussed the implementation of

---

these procedures with IRS officials in Washington, D.C., and Philadelphia; and observed implementation of the procedures at the Philadelphia Service Center, which is IRS' centralized processing center for tax credit information reported by state agencies. Furthermore, we reviewed the level of IRS' audit effort and the audit results, as well as IRS' use of the information from the state agencies. We performed this work at the Philadelphia District Office, where IRS examines tax credit returns. We also ordered data from IRS on tax year 1995 tax returns for the 396 project owners in our sample who were required to file partnership returns to determine whether the partnerships correctly reported the tax credits they were awarded. At the time we completed our field work, we had received and reviewed tax return data for 253 partnerships.

We obtained written comments on this report from IRS and NCSHA and oral comments from the Office of Management and Budget (OMB). We have summarized the relevant portions of their comments at the end of each chapter, if applicable, and reprinted the written comments, in entirety, in appendices V and VI. We also made copies of the report available to the Department of the Treasury and they had no comments on the report.

We performed our work between August 1995 and December 1996 in accordance with generally accepted government auditing standards.

---

## State Association Comments and Our Evaluation

NCSHA had comments on our methodology in two respects: (1) the number of large developments we included in our sample, and (2) the composition of the projects we included in appendix IV, "Results of Site Visits to GAO Sample Properties."

First, NCSHA said that our housing project sampling methodology was arbitrary because the sample included all developments with 300 or more apartments placed in service during the study period. We strongly disagree. We followed generally accepted sampling procedures for selecting a stratified random sample. Using this technique allowed us to reduce the size and cost of the sample while maintaining an adequate level of statistical precision for both project and housing unit estimates.

As discussed in this chapter, from the project universe data, we selected a stratified random sample of 423 projects containing nearly 50,000 units. The project universe was broken into two strata (large and small projects). All large projects, which consisted of projects with 300 or more tax credit units, were included in the sample. This eliminated sampling error for the

large projects. The projects in the small strata were drawn with a probability proportional to the number of units in the projects. The sample was designed to produce statistically sound, unbiased estimates of the characteristics of projects placed in service nationwide during the 3-year period.

We employed a stratified random sampling technique for a number of reasons. We wanted to select as small a sample as feasible so as not to burden the low-income housing industry, yet large enough to provide statistically reliable estimates. With regard to the latter, we also wanted to be sure to have data on the relatively small number of very large projects that provide housing for a large number of people and account for a significant portion of tax credit funding. The stratified random sample approach enabled us to address both objectives. As more fully described in appendix I, the estimates in the report were computed so as to adjust for the oversampling of large projects. Each of our sample of 423 projects was properly weighted to reflect its proportion in the population (small projects were more heavily weighted than large ones).

Second, NCSHA was concerned that appendix IV, entitled “Results of Site Visits to GAO Sample Properties,” includes a disproportionate number of large projects. As explained in the Objectives, Scope and Methodology section of this chapter, we judgmentally selected, on the basis of cost considerations, a subsample of 92 projects to visit to more fully validate their conditions and operations. Similar language has now been incorporated into appendix IV. The 15 projects described in that appendix were not intended to be representative of the population. They were intended to illustrate some of the project variety in the program. We did not include any very small projects because of the risk of revealing information about individual tenants.

---

# Low-Income Housing Tax Credit Properties: Their Residents, Characteristics, and Costs

---

Given the results of our sample, we estimate that about 4,100 properties with approximately 172,000 tax credit qualified units were placed in service in the continental United States between 1992 and 1994.<sup>1</sup> We also estimate that, for these projects, the states annually awarded tax credits with a potential value over their 10-year lifetime of about \$2 billion (about \$1.6 billion in present value terms), or about \$6.1 billion for the three years combined.

According to data we collected from property managers, the residents of these properties, the properties themselves, and the costs of developing the properties differed in many ways. A majority of the residents benefited not only from the federal tax credits but also from other federal housing assistance, such as rental assistance provided to residents and loan subsidies provided to property owners. Although tenant income data reported by property managers showed that virtually all of the households occupying tax credit units had low incomes, those who received rental assistance generally had much lower incomes than those who did not. Moreover, without this rental assistance, these households might not have been able to have afforded to live in their units. Households included families, single persons, elderly persons, and people with special needs.

Household rents, which we estimated at about \$453 a unit, were generally below the maximum rents allowed under the tax credit program. The properties are located throughout the United States in urban, suburban, and rural areas. Most of the buildings were newly constructed, although some had been rehabilitated. They included townhouses, garden apartments, and high-rise buildings with elevators. The estimated costs of developing the properties ranged from under \$20,000 per unit to over \$160,000 per unit, and the estimated potential cost of the tax credits awarded over the 10 year authorized period ranged from under \$10,000 per unit to over \$100,000 per unit in present value terms.

---

<sup>1</sup>Consistent and complete data on the residents of tax credit properties, the properties themselves, and property development costs were not available nationally when we started our work. As discussed in chapter 1, we collected these data from the tax credit allocating agencies and tax credit property managers. The statistics presented in this chapter are estimates based on our random sample of 423 projects placed in service between 1992 and 1994. The confidence intervals for estimates made from our sample are reported in appendix I.

---

## **Reported Incomes for Most Tax Credit Households Were Very Low**

As noted in chapter 1, to participate in the tax credit program, an owner must reserve a specific proportion of the units in the property for lower income households. At a minimum, the owner must set aside either (1) 20 percent or more of the units for households with incomes at or below 50 percent of the area's median income or (2) 40 percent or more of the units for households with incomes at or below 60 percent of the area's median income. All qualifying income standards are adjusted for family size, generally on the same basis as under HUD section 8 program. About 88 percent of the owners of properties placed in service between 1992 and 1994 chose the latter option.

Our analysis of data provided by tax credit allocating agencies shows that in practice, most owners rented virtually all of their units to qualifying households. We estimate that about 95 percent of the units in projects placed in service between 1992 and 1994 qualified for the credit.

On the basis of information provided by the managers of the tax credit properties placed in service during 1992 through 1994, we estimate that the 1996 average annual income of households in units qualifying for tax credits was about \$13,300 and about 60 percent of the households had incomes below \$15,000. (See fig. 2.1.) The majority of these households met HUD's definition of "very low income"—that is, their incomes were below 50 percent of their area's median income. Specifically, we estimate that about three-fourths of the qualifying households in these properties had incomes in 1996 at or below 50 percent of their area's median income. (See fig. 2.2.)



**Chapter 2**  
**Low-Income Housing Tax Credit Properties:**  
**Their Residents, Characteristics, and Costs**

**Figure 2.1: Estimated 1996 Incomes of Households in Tax Credit Units**

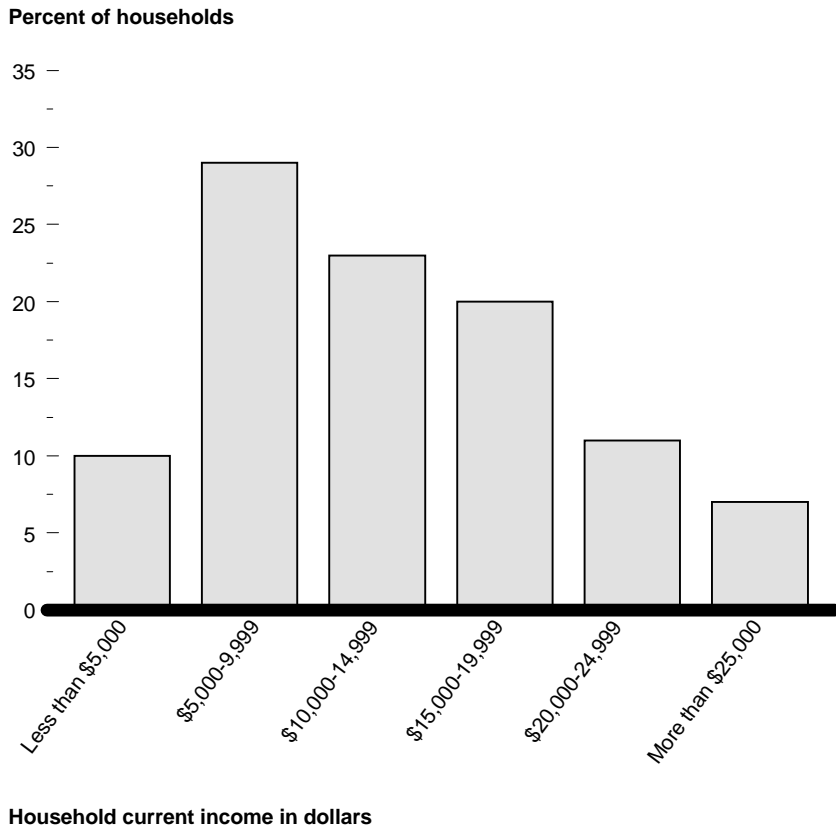

Source: GAO's analysis of data provided by tax credit project managers.

**Figure 2.2: Estimated 1996 Incomes of Households in Tax Credit Units Relative to Applicable Area Median Income**

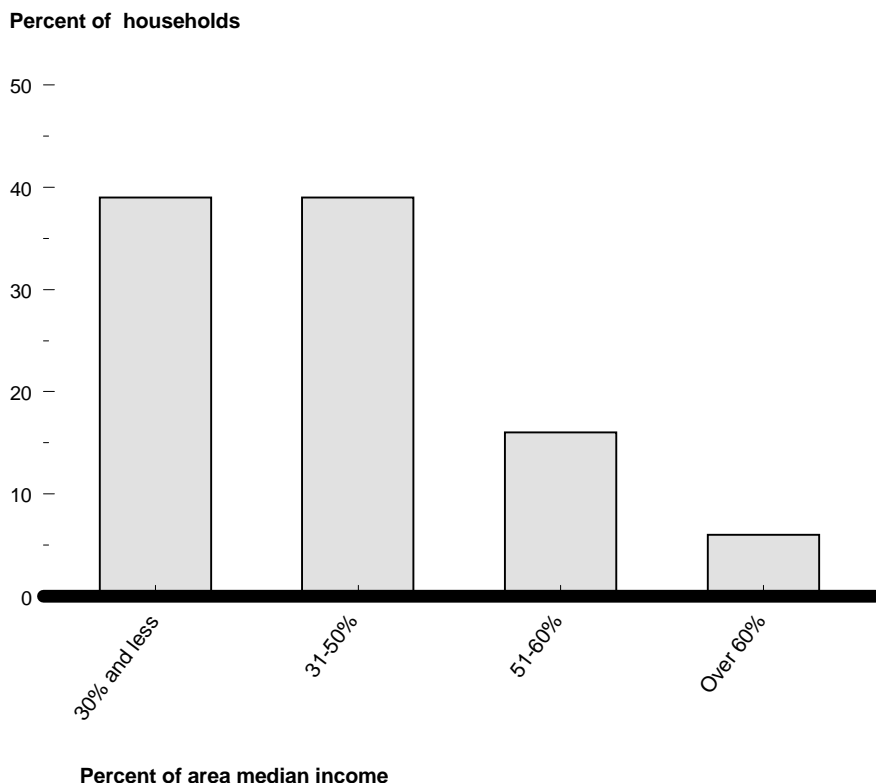

Note: The small percentage of households whose incomes exceeded the tax credit program's limit of 60 percent of area median income may not necessarily indicate noncompliance with the income limits because residents whose incomes increase while residing in tax credit units may remain in those units even if their incomes exceed the program's limits.

Source: GAO's analysis of data provided by tax credit project managers.

Our analysis of data provided by property managers shows that in 1996, an estimated 71 percent of the qualifying households in tax credit properties placed in service between 1992 and 1994 benefited directly or indirectly from one or more types of housing assistance besides tax credits. One type of housing assistance, direct rental assistance, enabled the tax credit program to serve many households whose reported incomes were well below the qualifying limits established by the program. Without such subsidies, these households might not have been able to afford these units. Overall, an estimated 39 percent of the tax credit households received direct rental assistance. These households would generally have paid a set

percentage of their income for rent—typically, 30 percent—and the balance was subsidized. As table 2.1 shows, we estimate that the average reported income of households in properties with rental assistance was about half of the average income of households without rental assistance. (App. II provides additional information on the current income of households with and without additional rental assistance.)

**Table 2.1: Estimated 1996 Incomes of Households With and Without Additional Rental Assistance Residing in Tax Credit Properties Placed in Service, 1992-94**

Type of Household	Percent of households	Average current income	Average income as a percent of the area's median income
Received additional rental assistance <sup>a</sup>	39	\$7,858	25
Did not receive additional rental assistance <sup>a</sup>	61	16,709	45
<b>All households</b>	<b>100</b>	<b>\$13,323</b>	<b>37</b>

<sup>a</sup>Appendix II provides information on income by type of housing assistance provided.

Source: GAO's analysis of data provided by tax credit property managers.

In addition to receiving rental assistance, many households benefited indirectly from government subsidized loans and grants provided to properties. Such assistance may have reduced owners' operating expenses or debt service costs, thereby allowing owners to charge lower rents than would have been possible without this additional assistance. For example, we estimate that almost one-third of the tax credit properties placed in service between 1992 and 1994 were financed by RHS mortgages, which generally carry interest rates of 1 percent. Additionally, an estimated 37 percent of the tax credit properties received subsidized loans or grants from numerous sources, including other federal programs, such as CDBG and HOME programs,<sup>2</sup> and state and local governments. Although the credit may be reduced for projects financed with federal funds, this restriction does not apply to federal financial assistance received under the CDBG and the HOME programs for projects meeting certain requirements.

<sup>2</sup>The CDBG and HOME programs provide federal block grants to states and localities and are typically used to provide below-market rate loans. CDBG may be used for housing and community development in low- and moderate-income communities, whereas HOME is limited to affordable housing projects.

## Tax Credit Households Were Generally Small and Projects Had Diverse Resident Populations

Data we obtained from tax credit property managers indicated that the tax credit program primarily served small households. We estimate that about 67 percent of the households included one or two people and the average household consisted of 2.2 persons. Figure 2.3 shows the distribution of households by size.

Figure 2.3: Estimated Size of Households in Tax Credit Properties Placed in Service, 1992-94

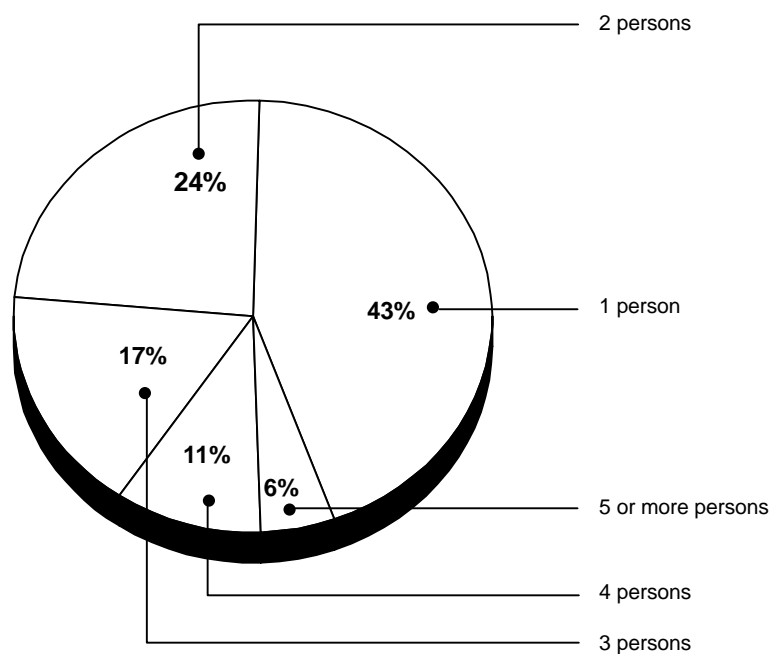

Note: Percentages do not total to 100 due to rounding

Source: GAO's analysis of 1996 data provided by tax credit property managers.

Our analysis of 1996 data provided by property managers, in which we used an approximation of HUD's section 8 subsidy standards,<sup>3</sup> indicated that overcrowding was generally not a problem for the residents of tax

<sup>3</sup>HUD's section 8 guidance states that no more than two people should sleep in a bedroom or living/sleeping area. Using an approximation of this standard: one person for an efficiency unit, two persons for a one-bedroom unit, four persons for a two-bedroom unit, six persons for a three-bedroom unit, and eight persons for a four-bedroom unit, we estimate that 2 percent of qualifying households live in units exceeding this measure and that about half of these are in one-bedroom units.

credit properties placed in service between 1992 and 1994. Given the preponderance of one- and two-person households, this is not surprising.

On the basis of our sample, we estimate that about 26 percent of the properties placed in service between 1992 and 1994 were primarily intended to serve the elderly; and about 5 percent were intended to serve people with special needs, such as those who were disabled or previously homeless.<sup>4</sup> The data on residents provided by tax credit property managers also indicated the following:

- approximately 64 percent of the households were headed by women;
- about 44 percent of the households were headed by a person under the age of 35, about 26 percent by a person between the ages of 35 and 54, and about 29 percent by a person aged 55 or older; and
- about 53 percent of the heads of households were white, 33 percent were black, 11 percent were Hispanic, and 3.5 percent were of other races.

---

## **Properties Were Widespread, Units Were Generally Small, and Rents Were Restricted**

On the basis of our sample, we estimate that about 4,100 properties developed under the tax credit program were placed in service between 1992 and 1994 in the continental United States. These data also indicate that about 95 percent of the units in the properties were awarded tax credits because they met the program's limits for income and rent. Appendix III provides further details on all properties placed in service between 1992 and 1994, as well as additional information on those we sampled.

---

## **Properties Were Widespread**

From our sample, we estimate that approximately 53 percent of the properties were in rural areas, 36 percent were in urban areas, and the balance were in suburban areas. However, almost half of the units were in urban areas, probably because urban properties often have more units. (See fig. 2.4.)

---

<sup>4</sup>We did not verify that the intended purposes of the properties, as reported by the tax credit allocating agencies, were met.

**Figure 2.4: Location Estimates for Tax Credit Properties and Units Placed in Service, 1992-94**

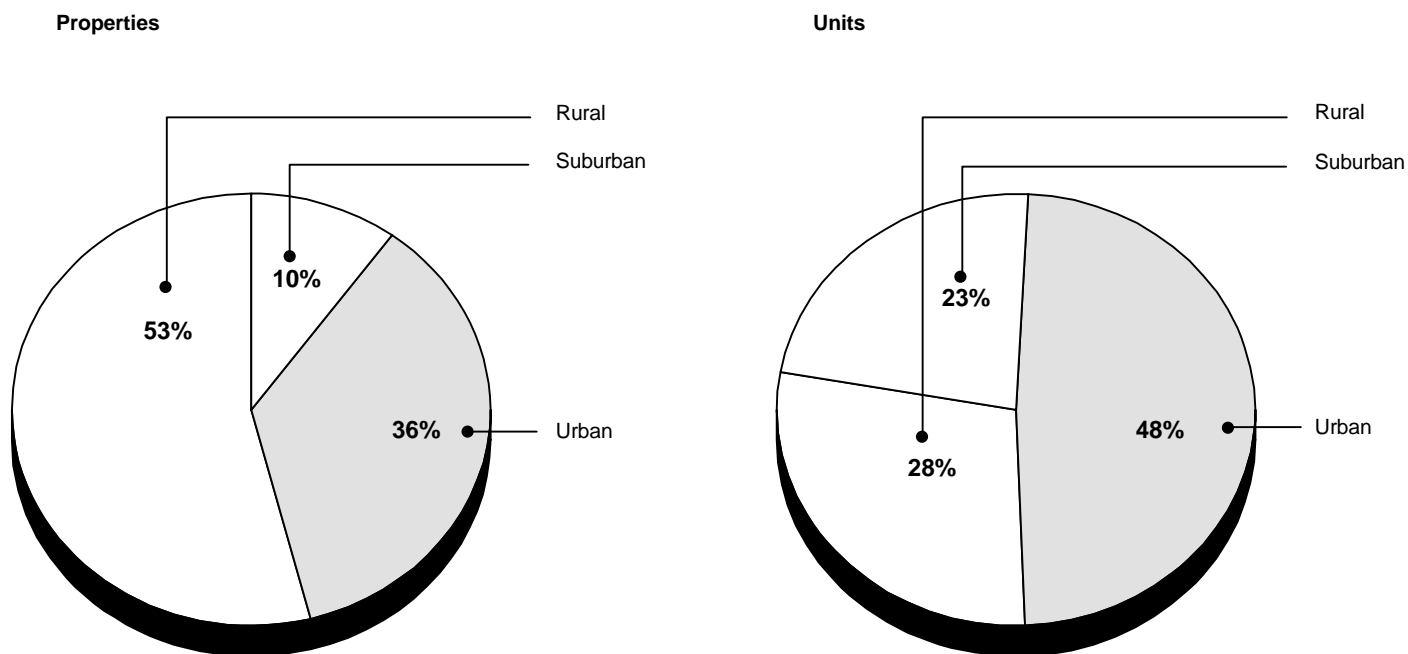

Note 1: Percentages do not add to 100 due to rounding.

Note 2: Location classifications were reported by tax credit property managers. We did not verify these classifications.

Source: GAO's analysis of data provided by tax credit property managers.

As discussed in chapter 1, the tax credit program provides some financial incentives to encourage the development of housing for low-income people in certain geographic areas. Specifically, the program provides incentives for locating properties in areas designated by the Secretary of HUD as (1) difficult development areas—metropolitan areas and nonmetropolitan counties where the costs of construction, land, and utilities are high relative to incomes; and (2) qualified Census tracts—tracts where at least 50 percent of the households have incomes less than 60 percent of their area's median gross income. A recent study conducted for HUD provides information that augments our property location data.<sup>5</sup> According to the study, about 37 percent of both the

<sup>5</sup>Development and Analysis of the National Low-Income Housing Tax Credit Database, Abt Associates, Inc. (July 1996).

properties and the units placed in service between 1992 and 1994 are located in difficult development areas and qualified Census tracts.

---

### **Property Styles Varied and Small Units Were Common**

Our data indicate that the most common type of tax credit property placed in service between 1992 and 1994 was a walk-up/garden-style apartment building. However, high-rise buildings, townhouses, and row houses were also well represented. Although we estimate that the tax credit properties averaged 43 units per property, about 4 percent of the properties were single-family detached homes. Most of the buildings—an estimated 73 percent—were newly constructed; the rest were existing and rehabilitated buildings.

Consistent with the large number of one- and two-person households living in the tax credit properties placed in service between 1992 and 1994, we estimate that 82 percent had two bedrooms or less. In addition, about 16 percent had three bedrooms, and about 1 percent had four or more bedrooms.

---

### **Rents Were Generally Below Allowable Maximums**

For units that are eligible for tax credits, rents are generally limited by the set-aside standard selected by the developer—that is, rents are usually limited to 30 percent of either 50 or 60 percent of the area’s median income, adjusted for unit size.

On the basis of our sample, we estimate that the average rents of tax credit units placed in service between 1992 and 1994 ranged from \$342 for an efficiency apartment to \$623 for a unit with four or more bedrooms in 1996. The average rent for units of all sizes was approximately \$453. Our analysis also showed that with some exceptions, the rents for tax credit units were lower than the maximum allowable rents for these units. Gross rents were between 13 and 23 percent lower than the maximum allowable rents, depending on unit size.

Under the Internal Revenue Code, for households occupying tax credit units only, the tenants’ rent payments are subject to the rent ceiling of the tax credit program. However, for tax credit units with rental assistance, the contract rent—which includes the household’s payment plus the rental assistance—may exceed the maximum allowable tax credit rent. We estimate that the contract rents for about 25 percent of the households with rental assistance (about 10 percent of all tax credit households) exceeded the tax credit rent limits that would have applied without this

exception. For an estimated 7 percent of the households with rental assistance (less than 3 percent of all tax credit households), the rents exceeded the general limits by more than 20 percent.

Rental assistance may be project-based or tenant-based. Project-based assistance is attached to designated property units whose owners receive a subsidy when the units are rented to qualified low-income households. In 1996, for the tax credit properties placed in service between 1992 and 1994, many households with contract rents above maximum allowable tax credit rents—and most households with contract rents substantially above these rent ceilings—resided in properties with project-based assistance.<sup>6</sup> For these properties, higher contract rents may have been included in the initial evaluation of the project's financial viability and allocation of tax credits. For example, at a large tax credit property in Michigan with section 8 project-based assistance, the contract rents for two-bedroom units were \$871. As permitted under the section 8 program, these rents exceeded the tax credit program's maximum allowable rent of \$550. According to the manager of this project, the project would not have been viable at the tax credit ceiling rent. Thus, the guarantee of contract rents above maximum allowable tax credit rents was essential to the initial determination of this project's financial viability.

By comparison, eligible households with tenant-based assistance may choose their rental units and retain their rental assistance if they relocate. Because of uncertainty over how many households with tenant-based assistance would actually choose to live in a tax credit property and for how long, we would not expect this assistance to have been considered in the initial determination of a project's financial viability or allocation of tax credits. Although information provided by property managers shows that fewer households with tenant-based assistance than with property-based assistance had contract rents that exceeded the maximum allowable tax credit rents, some of these households had contract rents substantially higher than rents of comparable households without rental assistance in the same property. In 1996, for example, households with tenant-based assistance in a New York City property had contract rents below the maximum allowable tax credit rents; however, their contract rents for a two-bedroom unit, on average, exceeded rents of comparable households without rental assistance by almost 30 percent—or about \$130

---

<sup>6</sup>To identify whether rental assistance was project-based or tenant-based, we first removed those properties with RHS 515 loan subsidies from our tax credit sample. We then contacted nearly all of the property managers for those remaining properties where at least 50 percent of the residents received a rental subsidy. If the project managers identified their properties as project-based, we designated them as such. We defined the remaining subsidized units as tenant-based.



a month. (See ch. 4 for further discussion of how rental assistance affects the federal cost of the tax credit program.)

---

### **Most Owners Were Limited Partners**

Most—an estimated 82 percent—of the tax credit properties placed in service between 1992 and 1994 were owned by limited partners; about 12 percent were owned by individuals. The remainder were owned by general partners and corporations. About 22 percent of the properties were developed by either a nonprofit organization or a for-profit subsidiary of a nonprofit organization.

---

### **Tax Credit and Development Costs Varied Widely**

When tax credit property owners use their tax credits, taxpayers subsidize the development costs of tax credit properties. However, total federal cost for tax credit properties includes the costs not only of the tax credits but also of other federal housing assistance provided to the majority of tax credit properties. Tax credit costs, other federal assistance, and development costs vary widely across tax credit properties. In chapter 4 of this report we discuss government controls designed to contain the costs of the tax credit program.

---

### **Tax Credit Costs Varied Widely**

For tax credit properties placed in service between 1992 and 1994, we estimate from our sample that the states had annually awarded tax credits with a potential value over their 10-year lifetime of about \$2 billion (about \$1.6 billion in present value terms). Thus, the taxpayers' costs for the tax credits attributable to these 3 years of placed in service projects could be as high as \$6.1 billion over the 10 year credit period. The federal cost of the tax credits is a function of many factors, including property development costs, the applicable tax credit rate, and the market price of the tax credits. We estimated that the present value of the average tax credit cost per unit over the 10-year period would be about \$27,310. However, as figure 2.5 shows, per-unit tax credit costs vary widely. Although an estimated 60 percent of the units had tax credit costs at or below the estimated average, we also estimate that 2 percent had tax credit costs of \$100,000 or more.

---

**Figure 2.5: Estimated Average Per-Unit 10 Year Tax Credit Costs of Properties Placed in Service, 1992-94**

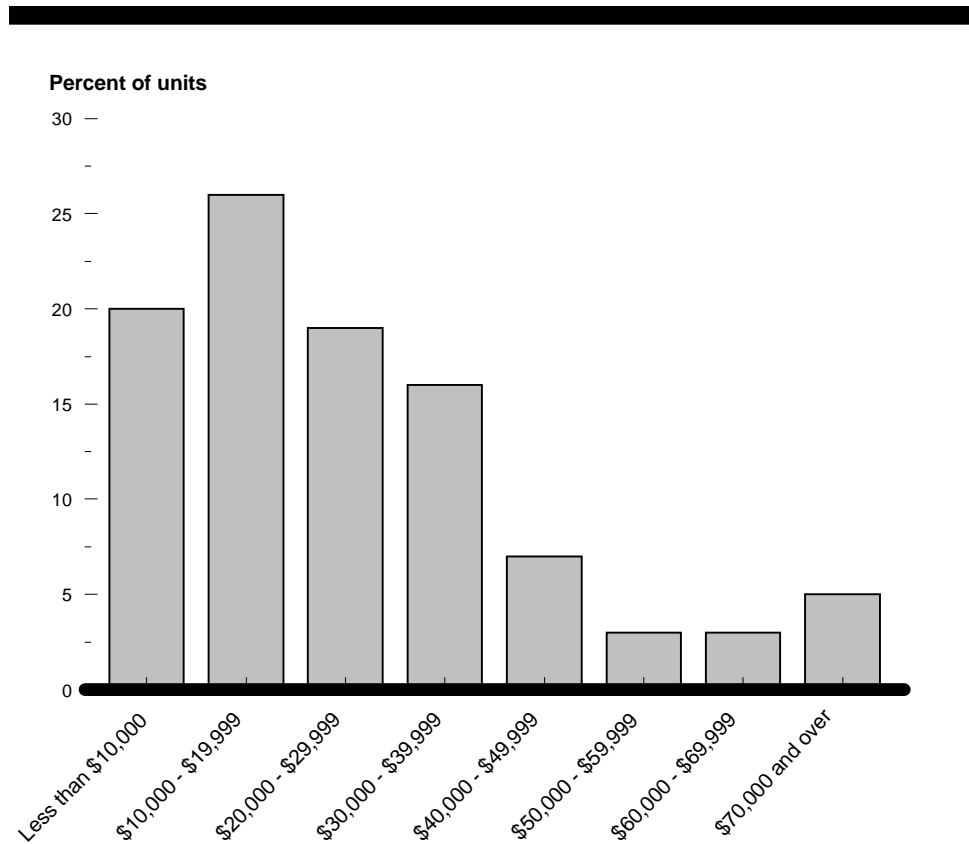

Note: The present value of the annual tax credits over the 10 year award period was calculated using an annuity-due approach with a discount rate of 6.7 percent. The discount rate is equal to the 10 year constant maturity of taxable U.S. government securities for calendar years 1992 through 1994.

Source: GAO's analysis of data provided by tax credit allocating agencies.

The federal costs of providing affordable housing for residents of tax credit projects are not always limited to the tax credit costs presented in figure 2.5: they could also include funding from other federal programs, such as HUD's section 8 rental assistance program; the Rural Housing Service's section 515 loan subsidy and section 521 rental assistance programs; and other loans, loan subsidies, and grants, including CDBG. In addition, state and local governments provide various kinds of assistance to tax credit projects.

**Properties' Physical Characteristics, Community Development Needs, and Controls Affect Development Costs**

Project development costs, including land acquisition outlays, building acquisition and/or construction costs, builders' overhead and profit, and financing costs, varied widely across tax credit properties. We estimate that the average cost of developing the units placed in service between 1992 and 1994 was about \$60,000.<sup>7</sup> About two-thirds of these units cost less than or the same as the average unit. The per-unit costs of tax credit properties varied substantially. About 10 percent of the units cost less than \$20,000, and about 10 percent cost more than \$100,000—including about 3 percent whose costs exceeded \$160,000 per unit. (See fig. 2.6.)

**Figure 2.6: Estimated Average Per-Unit Development Costs of Tax Credit Properties Placed in Service, 1992-94**

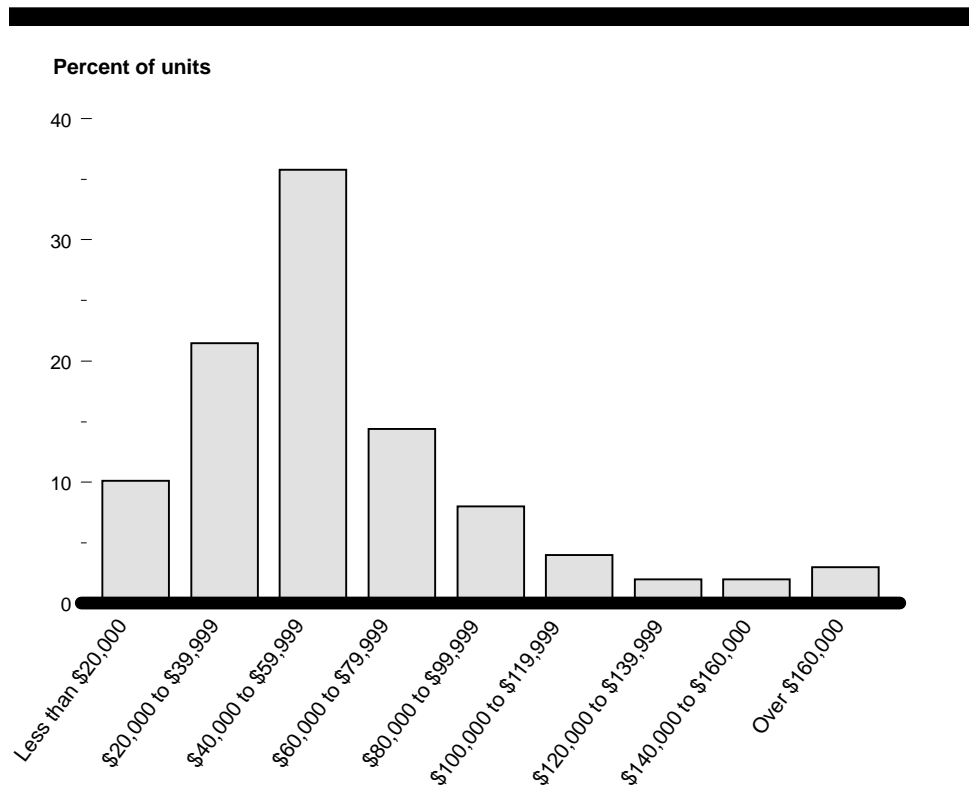

Note: Unit costs above \$160,000 generally ranged from about \$165,000 to \$259,000.

Source: GAO's analysis of data provided by tax credit allocating agencies.

<sup>7</sup>Development costs for about 10 percent of the properties include no costs for land because some allocating agencies either reported zero land costs or left this item blank. The average per-unit cost of properties with land costs was about \$59,700 compared with about \$58,200 for properties with no land costs.

Development costs may vary because of differences in the physical characteristics of properties, the need to meet broader community development needs, and the extent to which tax credit allocating agencies use various controls to limit costs.

Differences in the physical characteristics of properties—including the costs of acquiring land and existing buildings, the types of buildings constructed, the geographic location, the size of the units, the amenities provided, the construction standards used, and the environmental issues encountered—can account for some of the variation in development costs. We estimate, for example, that the average per-unit cost for newly constructed buildings was about \$68,000, and the average cost for substantially rehabilitated buildings was approximately \$48,000. Figure 2.7 illustrates the variations in cost associated with the type of construction, the location of the building, and the type of building.

**Figure 2.7: Estimated Average Per-Unit Costs of Properties Placed in Service, 1992-94, by Type of Construction, Location, and Building**

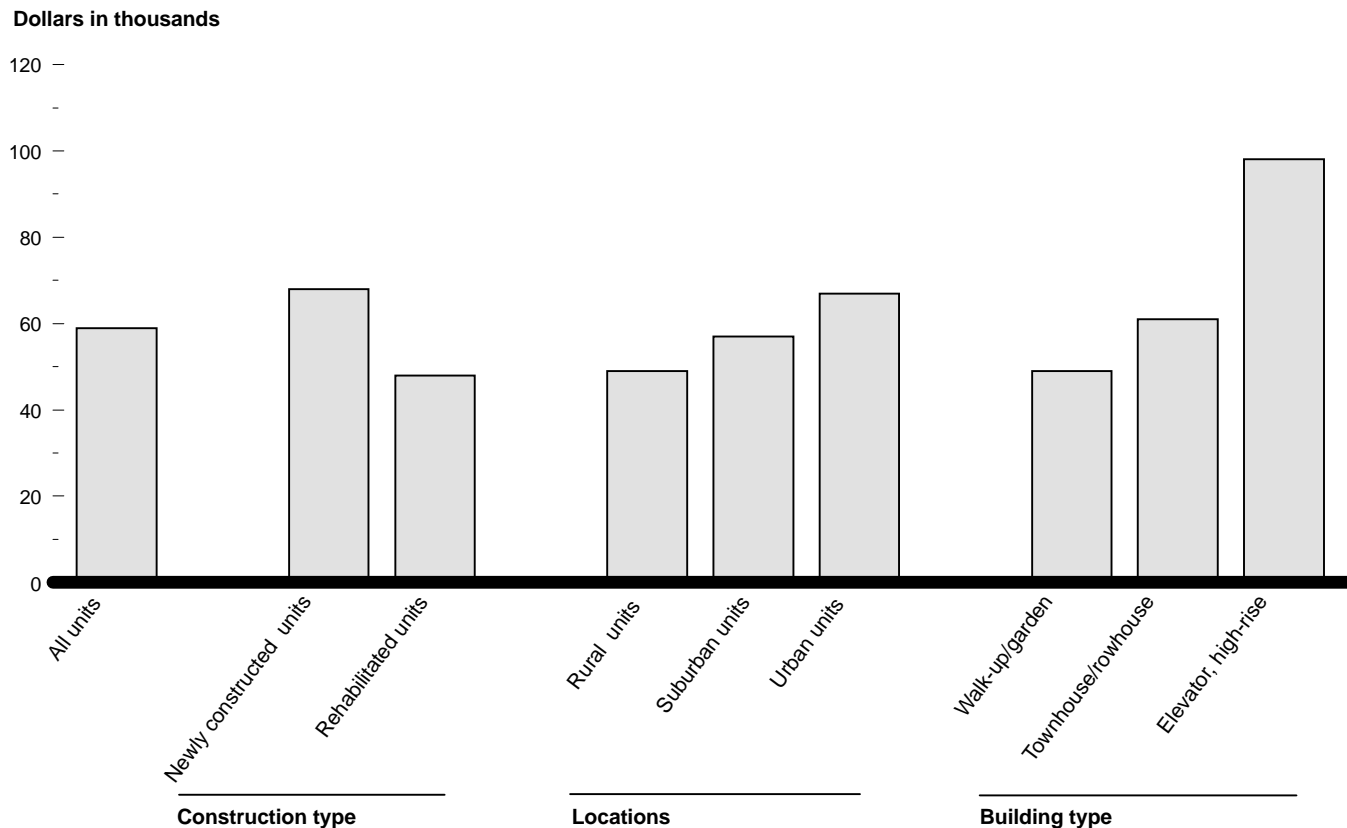

Source: GAO's analysis of data provided by tax credit allocating agencies.

Other physical characteristics—such as unusually high local construction costs, local seismic standards, or requirements for amenities to serve residents with special needs—may account for the higher development costs of some properties.

Development costs also vary because some tax credit properties are used to meet broader community development goals. For example, as discussed earlier, the basis for calculating tax credits may be increased for Census tracts where incomes dip below those of the wider area or communities

where development costs are high relative to incomes. Furthermore, tax credit projects may provide increased security or recreation for the surrounding community. In chapter 3 we discuss in more detail how physical and community development needs relate to the value of tax credits awarded.

Variations in allocating agencies' controls designed to limit development costs may also account for some of the variation in these costs. In chapter 4, we discuss allocating agencies' current efforts to control development costs in more detail and identify opportunities for strengthening these controls.

---

## Observations

Tax credit allocating agencies target and serve very low-income households by combining tax credits with other housing subsidies. Tax credit allocation amounts, which varied widely across the projects placed in service between 1992 and 1994, reflected differences in projects' development costs. Tax credit allocation amounts are also affected by tenant income levels through the rents tenants can afford to pay. Tax credit allocating agencies' controls over housing needs determinations and housing costs determines credit allocation amounts. These controls will be discussed in the following chapters.

---

## State Association Comments and Our Evaluation

In commenting on this report, NCSHA noted that although it had previously expressed concerns about potential bias and prejudgment in some aspects of our work, the report answered many of those concerns.

First, NCSHA said that the report "vindicates public predictions by GAO officials that nothing in the report could justify Housing Credit repeal." In response, we want to emphasize that GAO has never taken a position on whether the tax credit should be retained or repealed. Moreover, as clearly stated in the Objectives, Scope, and Methodology section of this report, our work was directed toward studying the controls established by the states and IRS for implementing the tax credit requirements. Making judgments as to the merits of the program relative to other low-income housing options was never intended to be, and was not, a part of our work.

Next, NCSHA indicated that the report also addresses some of its concern about potential bias and prejudgment on our part because the report documents how the tax credit is "exceeding" its objectives and cited as evidence a number of income, rent, and cost estimates in the report. For

---

**Chapter 2**  
**Low-Income Housing Tax Credit Properties:**  
**Their Residents, Characteristics, and Costs**

---

example, NCSHA pointed out that although the law allows renters in tax credit projects to have incomes up to 60 percent of area median income, our report states that more than three out of four had incomes under 50 percent. Contrary to NCSHA's interpretation, we did not take a position as to whether or not the tax credit is exceeding its objectives. Further, we note that some of the examples cited by NCSHA are clearly attributed in our report to the use of other government subsidies (loan, grant, and rental assistance subsidies discussed in this chapter) in conjunction with tax credits.

Other NCSHA comments regarding its concerns about potential bias and prejudgment in certain aspects of our work and our responses to those concerns are presented at the end of chapters 1, 4 and 5.

# States' Controls for Allocating Credits to Housing Needs Vary

The Internal Revenue Code establishes broad requirements for allocating tax credits to proposed housing projects, giving the housing credit allocating agencies wide latitude in implementation. Under the Code, the agencies must develop qualified allocation plans that target their tax credits to proposed projects that meet their housing priorities and contain selection criteria that are appropriate to local conditions. The agencies must also give preference to proposed projects that serve the lowest income tenants and that serve qualified tenants for the longest periods.<sup>1</sup>

Through the allocation process, the agencies have defined and applied the tax credit program's requirements in various ways. Some have called for more data and analysis than others, particularly in assessing their housing needs, and some have implemented more stringent controls for allocating tax credits than others. For example, all of the agencies have used Census data to identify and rank their housing needs, and some have taken steps to overcome limitations in these data. Similarly, all of the agencies have established controls for allocating tax credits. The 20 allocation plans that we reviewed weighted the selection criteria by using thresholds, set-asides, points, and rankings. Despite the differences among the plans we reviewed, all of them provided for targeting tax credits to proposed projects as required.

Several factors could affect the actual housing delivered over time. First, nearly all of the plans we reviewed afford the agencies some discretion for bypassing the results of the process. Second, the tax credits allocated to proposed projects exceeded the tax credits awarded to projects when placed in service, and we were unable to account for this difference. Finally, the long term economic viability of low-income housing projects subject to extended use agreements has not been tested.

---

## Internal Revenue Code Gives Agencies Wide Latitude in Allocating Tax Credits

Section 42 of the Internal Revenue Code requires the housing credit allocating agencies to develop qualified allocation plans to target their tax credits to proposed housing projects that meet their "housing priorities" and that include selection criteria that are "appropriate to local conditions." In addition, the Code requires the agencies to "give preference" to projects "serving the lowest-income tenants" and projects "obligated to serve qualified tenants for the longest periods." Because the Code does not define these terms or set forth procedures for implementing

---

<sup>1</sup>The qualified allocation plan must be approved by the governmental unit of which the agency is a part after a public hearing. The agency must notify the chief executive officer of the jurisdiction in which the project is located and give the official opportunity to comment.



the program's requirements, it gives the allocating agencies the flexibility to respond to their particular needs.

Besides establishing these broad requirements, the Code specifically directs the agencies to include seven "selection criteria" in their allocation plans. The Code does not define these criteria or provide any guidance for their use. Generally, however, they serve as indicators of housing needs and the ability of proposals or developers to satisfy those needs.

In responding to our survey, all 54 allocating agencies reported having developed qualified allocation plans. We reviewed the controls incorporated into the plans but did not test whether housing delivered by the plans satisfied state housing priorities or the other program requirements.

Under the low-income housing tax credit program, it is up to the states to identify best practices, consider the costs and benefits of alternative approaches, and select the approaches best suited to their conditions. NCSHA has established a commission to examine ways to improve various aspects of the credit program, including how allocation plans allocate credits to housing needs.

The information presented in this chapter is derived primarily from our survey of the 54 allocating agencies and from our review of 20 agencies' qualified allocation plans. Although our sample of 20 agency plans was not random and cannot be projected to all plans, the 20 plans cover about 65 percent of the credits awarded annually.

---

## **Agencies Have Defined the Program's Requirements in Different Ways**

Before developing their qualified allocation plans, the allocating agencies must define their housing priorities and the terms "appropriate to local conditions," "lowest-income", and "longest periods." Our review showed the agencies have defined these program requirements in different ways and, when evaluating the requirements, have used varying amounts of information and analysis.

---

## **Agencies Primarily Relied on Consolidated Plans to Define Their Housing Priorities**

Although the Internal Revenue Code does not specify how the allocating agencies are to identify their housing priorities, HUD has, since 1994, required the states to develop consolidated plans to identify and rank their housing needs for several federal programs, including CDBG and the HOME Investment Partnership programs. In addition, HUD requires the states, in

their consolidated plans, to develop a strategy for coordinating their housing resources—including their tax credits—to meet their identified housing needs.<sup>2</sup>

Of the 54 allocating agencies we surveyed, all but 1 said that their jurisdictions had developed a consolidated plan and used it to identify the jurisdictions' housing needs. About two-thirds of the agencies reported relying primarily on this plan to identify their housing needs for the tax credit program. Most of the remaining agencies said they had identified their housing needs using advisory committees, the knowledge of their staff, and/or historical data that complemented or later fed into their consolidated plans.

In responding to our survey, the allocating agencies identified their housing needs in terms of problems to be solved and populations to be served. The most frequently cited problems were excessive rent burdens (89 percent), followed by substandard housing (72 percent), a lack of housing (59 percent), deteriorated neighborhoods (52 percent), and excessive concentrations of very low-income housing (30 percent). Translated into solutions, these include needs for less expensive housing, the rehabilitation and maintenance or replacement of existing housing, additional housing, community revitalization, and mixed-income development. The majority of the agencies (78 percent) also expressed a strong need for subsidized housing in rural areas. The populations most frequently identified as needing housing were the elderly (70 percent); large families (67 percent); and persons with special needs, including those who are handicapped, disabled, or homeless or have AIDS (63 percent).

### States Used Census Data to Develop Their Consolidated Plans

To develop their consolidated plans, the states rely primarily on special tabulations of demographic and housing data from the 1990 Census that HUD developed in collaboration with the Bureau of the Census. For each state, HUD printed a limited set of key indicators of housing supply and demand for all counties and for major cities. Key indicators of supply include the number of rental units by price and size; the vacancy rate; and, to a limited extent, the physical condition of the housing.<sup>3</sup> Key indicators

---

<sup>2</sup>The consolidated plan required by HUD differs from the qualified allocation plan required under the Internal Revenue Code. Whereas the consolidated plan identifies and ranks housing needs, the allocation plan targets tax credits to proposed projects that best satisfy identified housing priorities. The Code does not require the allocating agencies to use the consolidated plan to identify their housing priorities for the qualified allocation plan.

<sup>3</sup>Measures of physical condition include (1) the number of units lacking complete kitchens and plumbing, heating, electricity, and maintenance; (2) the age of the housing; (3) the source of the housing's water supply; and (4) information on whether the units are boarded up or abandoned.

of demand include the number of renter households, as well as their size, type, income level, and racial composition. In addition, more extensive tabulations of Census data are available to the states if they wish to conduct more detailed analyses. These tabulations enable the states to analyze certain indicators of their housing needs in areas as small as a neighborhood block.

To identify their housing needs, the states can compare their indicators of supply and demand with standards for adequate housing developed by HUD. According to these standards, for example, households should pay no more than 30 percent of their income for rent, units should have one room per person, and apartments should include complete kitchens and plumbing facilities. Comparisons of a state's indicators with HUD's standards may show that certain groups in the state have excessive rent burdens, are living in overcrowded conditions, or are living in substandard housing. The states can use their Census data to assess these problems globally or by region, county, city, or even, to a more limited extent, neighborhood.

#### Census Data Have Limitations

Although the Census is a consistent, national source of demographic and housing data, its information on the physical condition of properties is limited. Furthermore, its statistics may be outdated because it is performed only once every 10 years, and the data are collected well before they are published. To measure the physical condition of their rental housing, many of the states whose consolidated plans we reviewed relied primarily on indicators of age and the existence of kitchen and plumbing facilities. This approach provides little information on whether properties are, in fact, habitable or on whether their internal condition conforms to their external condition. To update the 1990 Census data, the states generally used historical trends to project current conditions. This approach, while reasonable, may not be accurate when major changes have taken place in a state's housing markets.

#### Some States Supplemented, Updated, or Further Analyzed Census Data

To obtain more detailed or more current information, some of the states whose consolidated plans we reviewed supplemented or updated their Census data. California inventoried its rental properties, Texas surveyed interest groups and residents, and Maryland convened regional advisory groups. New York City asked the Census to perform a special survey to update its data, and Florida hired a contractor to obtain current data. Although efforts such as these cost more than using existing indicators, they can generate a richer database for identifying housing needs and developing strategies to meet those needs. Delaware, for example,

identified almost 1,400 additional units in substandard condition through a field survey that it commissioned to supplement its Census data. Furthermore, through a review of county code enforcement records, it determined that in one county, where fewer building code violations were recorded, the violations were more serious and more expensive to correct than in other counties. According to the state, such a distinction could not have been made using the Census data alone.

Despite their limitations, the Census data can be used to analyze the causes of problems such as high rent burdens and overcrowding. To varying degrees, the states have used their tabulations of Census data to analyze the availability, adequacy, affordability, and accessibility of rental housing. For example, although most states assessed availability by comparing the rate of growth in rental units with the rate of growth in the tenant population, Texas, Vermont, and Ohio performed further analyses to determine whether they had enough affordable units for tenants at different income levels. These additional analyses revealed shortages that the states had not previously detected and might not otherwise have sought to address.

---

**Agencies Used Market  
Studies to Define  
Appropriateness to Local  
Conditions**

As discussed in the preceding paragraphs, the states have taken various steps to obtain the data required to identify and rank their housing needs in their consolidated plans. These steps, while sufficient to establish housing priorities for a state as a whole, a region, or even a locality, may not be adequate to determine whether a particular property will be viable in a particular location. Accordingly, the Internal Revenue Code requires the allocating agencies to determine the appropriateness of a proposed project to local conditions. As noted, the Code does not define the term "appropriate to local conditions," and it does not establish a procedure for determining appropriateness.

In responding to our survey, all of the allocating agencies reported using some procedure(s) to determine appropriateness to local conditions. Most said that they reviewed their consolidated plans, community plans, or neighborhood plans, and most reported taking steps to ensure consistency with local zoning regulations. Some reported requiring, or giving preference to proposals with, letters of support from local officials or local funding commitments. And the vast majority reported requiring market studies or property appraisals, both of which review a market area and assess comparable properties within that area.

Both HUD<sup>4</sup> and the real estate industry have established general criteria for market studies—namely, that they should be comprehensive, independent, and timely. A comprehensive study identifies the demographic characteristics of the market area, potential tenants, and comparable properties, as well as the probable impact of the proposed property on rents and vacancy rates in the market area. An independent study is performed by a neutral or third party. It is also more likely to be objective if it is commissioned by an allocating agency rather than a developer. A timely study is both up to date and complete before a project's application for tax credits is reviewed. The costs of market studies vary with their complexity.

Forty-one of the 54 allocating agencies reported relying to some degree on market studies. Our review of the qualified allocation plans for 20 agencies indicated, however, that these agencies' requirements for market studies varied considerably.<sup>5</sup> Whereas some agencies set forth extensive, specific criteria, others established very general requirements:

- Florida's agency requires that a market study identify and evaluate the (1) best comparable and competitive existing and proposed properties; (2) project's dynamics, including rents, designs, and amenities; (3) historic, current, and forecasted absorption rates; (4) occupancy and vacancy levels in the market; and (5) population growth trends and other demographic data.
- Texas requires an analysis of many of the same factors, as well as an overall opinion by the analyst on the adequacy, feasibility, and reasonableness of the project's costs, absorption rates, rent levels, and reserves.
- Nevada's agency requires "a description of the project substantiating community need" and a market or feasibility study that is "acceptable" to the state.
- Virginia does not require a market study but will consider one if it is submitted with the application.

The following cases illustrate the importance of obtaining comprehensive information about a market area before investing in a project's development:

---

<sup>4</sup>HUD requires independent market studies for all multifamily projects applying for mortgage insurance through the Federal Housing Administration.

<sup>5</sup>We did not attempt to assess whether the agencies' requirements satisfied HUD's and the industry's criteria for comprehensiveness, independence, and timeliness. Neither did we try to determine whether the studies accepted by the agencies satisfied the agencies' own requirements for the studies.

- A market study for a large suburban project analyzed the area's existing and anticipated rental housing market, demographics, economy, and demand for housing. The study (1) reviewed vacancy rates, (2) analyzed the perceived value of the proposed rent levels within the market and estimated absorption rates with and without tenants using section 8 vouchers, and (3) compared proposed rents with existing market-driven rents. The project's rental agent said the developer was very pleased with the study, which accurately predicted that the property's units would be rented within 10 months.
- Another market study concluded that the elderly population in a rural area was large enough to support a three-story project for elderly tenants. However, the study did not reveal that many of the elderly were ineligible for the project because their disability benefits raised their incomes above the program's limits. Furthermore, the study did not determine the housing preferences of the potential tenants. The project has not leased its units as rapidly as scheduled. According to the rental agent, many of the elderly consider an "elevator building" with internal units too confining or "above their station in life." The developer said that if he had obtained this information before constructing the project, he would have built fewer units in a more open design.

The allocating agencies' requirements for independence and timeliness also varied considerably. New Hampshire, which determines the need for a market study on a case-by-case basis, requires three bids from independent third parties. Although the developer pays for the study, the allocating agency commissions it, thereby controlling the study process. Several other states require that the study be performed by an independent third party according to the state's guidelines. Some agencies had no requirements for independence. The agencies with a requirement for timeliness generally specified that the market study be no older than 6 months (Texas) or 1 year (California and Ohio) when it is submitted with a project's application for tax credits. Most of the agencies required that the study be submitted with the application.

---

### **Agencies Have Defined Lowest Income and Longest Periods**

Using the discretion allowed in the Internal Revenue Code, agencies differed in defining the terms "lowest income" and "longest periods." All of the 54 allocating agencies reported giving preference to proposed projects serving the lowest income tenants, and 49 of the agencies reported giving preference to proposed projects with agreements to serve qualified tenants for longer periods of time than the federal law requires. Such agreements are commonly referred to as extended use agreements.

---

**Lowest Income**

The Internal Revenue Code limits tax credit assistance to housing for households with incomes of up to 60 percent of the local area's median income. Within this limit, the allocating agencies' definitions of lowest income vary slightly, in part because different agencies rely on the tax credit program to serve different income levels. As noted at the beginning of this chapter, HUD requires the states, in their consolidated plans, to develop strategies for coordinating their available housing resources. Compared with some other housing resources, tax credits can be used to subsidize housing for households with higher incomes. Section 8 subsidies and public housing, for example, must serve a majority of households with incomes at or below 50 percent of the local area's median income.

In reviewing several states' consolidated plans, we found that different states assigned different roles to the tax credit program. Whereas Texas planned to use its tax credits for households with incomes between 31 and 50 percent of their area's median income, North Carolina targeted its allocation to renters with incomes between 51 and 60 percent of their area's median income. North Carolina's consolidated plan specified that renters with incomes between 0 and 50 percent of their area's median income would not be served through the tax credit program. Florida listed tax credits among the many resources available to the state without specifying what income levels the tax credit program would serve.

Our review of the qualified allocation plans for 20 agencies indicated that some of these agencies capped their definition of the lowest income at 50 percent of the local area's median income.

**Longest Periods or Extended Use**

As discussed in chapter 1, the Tax Reform Act of 1986 initially required tax credit housing to serve low-income households for 15 years. Amendments in 1989 extended that requirement from 15 to 30 years but included a contingency clause that could, in some instances, permit a sale that would result in a property's conversion to market-rate housing after 15 years. If such a conversion took place, the current low-income tenants would be protected for up to 3 more years.

Our review of the qualified allocation plans for 20 agencies indicated that most of the plans gave preference to proposals that (1) commit beyond 30 years and/or (2) waive the option of seeking to convert to market rates until some point beyond the fifteenth year.

---

## Allocation Plans Weight Selection Criteria

Defining the tax credit program's broad requirements, including "housing priorities," "appropriate to local conditions," "lowest income," and "longest periods," is one step in developing the required qualified allocation plan. Another step in developing a plan is to specify and weight selection criteria that will target tax credit awards in accord with the program's broad requirements. The Internal Revenue Code lists seven selection criteria that must be included in a qualified allocation plan and allows agencies to use additional criteria. The 20 plans we reviewed weighted the selection criteria by employing thresholds, set-asides, point systems, and rankings.

---

## Selection Criteria

The seven selection criteria listed in the Internal Revenue Code are

- project location,
- housing needs characteristics,
- project characteristics,
- sponsor characteristics,
- participation of local tax-exempt organizations,
- tenant populations with special housing needs, and
- public housing waiting lists.

Consistent with the flexibility afforded in the Code, the allocating agencies have defined the selection criteria differently. For example, in the 20 allocation plans we reviewed, one criterion—housing needs—stood not only for different types of construction (e.g., new construction, substantial rehabilitation) and different sizes of units (e.g., single room, three or more bedrooms) but also for different types of tenants (e.g., elderly, large families, people with special needs) and several other types of needs.

Most of the 20 plans that we reviewed included other criteria, such as indicators of cost efficiency (e.g., low per-unit costs, low developers' costs, low state costs, low per-unit requirements for tax credits, and efficiency in leveraging funds from other sources);<sup>6</sup> readiness to proceed with development; and evidence of financial commitments. Many of the plans also treated indicators of appropriateness to local conditions, such as market studies or letters of support from local officials, as selection criteria. Finally, many of the plans treated as selection criteria the tax credit program's requirements for giving preference to proposed projects

---

<sup>6</sup>As discussed in chapter 4, including some of these indicators of cost efficiency in the allocation plans seems to have helped to control costs in some states.



---

serving the lowest income tenants and serving qualified tenants for the longest periods.

---

## Weighting of Selection Criteria

The 20 allocation plans that we reviewed weighted the selection criteria by using thresholds, set-asides, points, and rankings. Competition among developers for tax credits encourages developers to propose projects that satisfy more of the selection criteria.

The weighting systems had different advantages. Generally, compared to points and rankings, thresholds and set-asides afforded more certainty, while points and rankings provided more flexibility. A threshold virtually ensures that a particular requirement will be met—if a proposal satisfying the threshold is submitted—because a proposal is not to be considered unless it satisfies the requirement. A set-aside, while not as broad in scope as a threshold, nevertheless reserves a portion of an agency's allocation for projects satisfying a particular requirement. New Jersey, for example, set aside 10 percent of its allocation for projects serving tenants with special needs. Point and ranking systems may allow more flexibility for making trade-offs among multiple selection criteria. The extent to which a scoring or ranking system targets tax credits to projects satisfying a particular requirement depends on the relative weight assigned to the requirement and the level of competition for tax credits.

---

## Allocation Plans Provided for Targeting Tax Credits

To gain more insight into the allocating agencies' approaches for weighting selection criteria in their allocation plans, we focused on the means used to give preference to proposed projects serving the lowest income tenants and serving qualified tenants for the longest periods. Our review found that the allocation plans' controls provided for selecting proposals designed to satisfy the requirements of the tax credit program requirements. However, we also found that the qualified allocation plans can be bypassed and tax credits awarded on some other bases. This section discusses the selection procedures in the qualified allocation plans. Later we discuss how and when the plans can be bypassed.

---

## Plans Provided for Giving Preference to Lowest Income

In responding to our survey, all of the 54 allocating agencies reported giving preference to proposed projects serving the lowest income tenants. Eleven of the agencies reported making this requirement a threshold, and most said that they awarded a higher score or bonus points to proposals satisfying the requirement. Most of the 20 qualified allocation plans that

we reviewed treated the requirement as a selection criterion. Two plans established income thresholds, and most used points or rankings to measure proposals' commitments to the lowest income tenants. California's plan, for example, set thresholds for income levels for different types of projects; thus, projects for large families could not be considered for tax credit awards unless they served families with incomes at or below 45 percent of the local area's median income. Among the plans that awarded points, the number often increased as the targeted income levels decreased. For example:

- Michigan's plan increased the number of points—up to 140 out of 347—with the number of units set aside for households at 50 percent, 40 percent, 30 percent, and 20 percent of the area's median income.
- Florida's plan awarded up to 90 out of 945 points for projects serving low-income households, increasing the number of points with the percentage of units targeting lower income levels from 60 percent down to 35 percent of the area's median income.
- Rhode Island's plan awarded 5 out of 225 points for projects in which at least half of the units were reserved for households with incomes below 45 percent of the area's median income.

In comparison, New Jersey's plan relied primarily on competition, assigning priority rankings to the projects serving the households with the lowest incomes.

Several of the allocating agencies whose plans we reviewed used other selection criteria to target tax credits to proposed projects serving tenants with low or very low incomes:

- Connecticut, New York, and Rhode Island awarded points under the location criterion to projects in areas with high disparities between rent and income levels.
- Illinois applied the project characteristics criterion to award points to projects serving the lowest income tenants.
- Virginia used the housing needs criterion for the same purpose.
- Maryland created its own selection criterion for leveraging other funds and awarded points for projects with long-term subsidies, such as project-based rental assistance, which is reserved for very low-income households.
- Vermont developed rankings for projects that had met three thresholds for cost efficiency; these rankings were based, in part, on how effectively the projects combined resources to enhance affordability.

In responding to our survey, all of the 54 allocating agencies reported using the public housing waiting list criterion in their allocation plans, as the Internal Revenue Code requires. The 20 plans we reviewed reserved relatively few points for satisfying this criterion; nevertheless, selecting tenants from a public housing authority's waiting list would generally imply serving the lowest income tenants.

- Illinois awarded 5 percent of its points for a written agreement to give preferential treatment to households on a public housing authority's waiting list.
- Ohio awarded under 1 percent of its points for such an agreement.
- Michigan deducted 6 percent of its points from proposals that did not provide for selecting the tenants for at least six units from a public housing authority's waiting list.

Several of the plans we reviewed provided multiple opportunities for targeting tax credits to proposed projects serving households with low or very low incomes. Pennsylvania's plan, for example, used a set-aside and points to give preference to such households under at least five selection criteria:

- The location criterion divided the state into regions and set aside a portion of the total allocation for each region. The amount of each region's set-aside was proportional to the number of households with incomes at or below 50 percent of the area's median income.
- The housing needs criterion provided for awarding up to 22 out of 100 points for projects reserving at least 50 percent of their units for households with incomes at or below 50 percent of the area's median income.
- The project characteristics criterion provided for awarding up to 19 points for projects designed to preserve existing low-income housing.
- The public housing waiting list criterion made up to 4 points available for projects with a letter from a local public housing authority saying that tenants on its waiting list would be referred to the tax credit project.
- The criterion for giving preference to the lowest income tenants made up to 14 points available for projects offering support, financial, or other services to meet the needs of very low-income households.

Finally, combining tax credits with funds from other public programs that target lower income levels enables tax credit projects to serve tenants at these lower levels. In these cases, the more stringent income limits prevail.

Thus, even if an allocation plan does not use controls such as points or rankings to help select projects that combine tax credits with resources from other programs with lower income limits, such combinations ensure that the lower incomes will be targeted.

---

### **Plans Provided for Giving Preference to Extended Use**

In responding to our survey, 49 of the 54 allocating agencies reported giving preference to projects with agreements to serve qualified tenants for longer periods of time than the federal law requires. Seven of these agencies reported making extended use a threshold, and almost all of the others said that they gave higher scores or awarded extra points to projects with extended use commitments. Overall, we estimate that about two-thirds of the projects placed in service between 1992 and 1994 had extended-use commitments exceeding the federal requirements—committing beyond the 30 years or waiving the option of seeking to convert to market rate until some point beyond the fifteenth year.

Our review of 20 allocation plans showed that two agencies—California and Massachusetts—established thresholds to ensure that all of their tax credit projects had agreements to serve low-income households for at least 30 years. New Hampshire awarded points for agreements not to seek a market-rate sale for 30 years, while Florida required applicants to waive their right to a sale after 15 years and awarded points for agreements to serve low-income tenants from 31 to 50 years. Other agencies awarded points or higher rankings to projects with extended use commitments. Those that awarded points generally increased the number for each year over the federal requirement. For example:

- Michigan awarded 1 point for each year over 15 years up to 45 years, or 35 points for low-income use in perpetuity; and
- Massachusetts added points to its 30-year threshold, awarding 10 points for a 40-year commitment and 15 points for a 50-year commitment.

New Jersey used a priority ranking system for the projects competing in a particular round, assigning the highest rank to the project with the longest commitment to low-income use.

Giving consideration to sponsor characteristics also seems to support the requirement for giving preference to extended use, much as considering the public housing waiting list criterion reinforces the requirement for giving preference to the lowest income tenants. For example, 22 percent of the properties placed in service from 1992 through 1994 had nonprofit

sponsors or were tied to nonprofit organizations. According to syndicators that work primarily with nonprofit sponsors, when investors invest in tax credit projects through their organization, there is an informal agreement to sell the properties to nonprofit entities after the initial period of compliance with the program's requirements has expired.<sup>7</sup> It is assumed that the nonprofit entity will then operate the property for low-income households indefinitely.

Combining tax credits with funds from another public program can increase a project's commitment to extended-use as well as to the lowest income tenants. Again, the more stringent requirement prevails. We estimate that 32 percent of the properties placed in service from 1992 through 1994 received section 515 loans through the Rural Housing Service. Because these 50-year loans do not include a prepayment option, the projects are required to serve low-income tenants for at least 50 years. Similarly, an estimated 5 percent of the projects received financing through the HOME Investment Partnership. When new construction is involved, the HOME program carries a 20-year commitment to low-income use. Nonurban projects with loans from the housing finance agencies in New Jersey and projects in New York City are required to serve low-income households for 30 years.

In several states, competition seems to have lengthened extended-use requirements. California, for example, increased its threshold for extended use from 30 years in the 1995 allocation cycle to 55 years in the 1996 cycle because developers, responding to competition, were routinely offering 55-year commitments. During the 1996 allocation cycle, Virginia gave higher scores and bonus points for extended-use commitments. All 71 qualifying proposals provided either for extended use or for tenants to purchase their units at the end of the compliance period. Many of the allocation plans we reviewed offered a comparatively high percentage of their total points (from 8 to 15 percent) or a relatively high priority ranking (the third out of seven steps for Vermont) for extended use, making this criterion comparatively sensitive to the effects of competition.

Whether housing projects subject to extended-use requirements actually provide housing to low-income tenants on a long-term basis depends, in

---

<sup>7</sup>The use of informal agreements arises because a nonprofit organization may not negotiate a below-market purchase option with investors during a project's initial development. Apparently, there was concern that giving a nonprofit organization such an option would result in the investors losing ownership of the property and the accompanying tax benefits of ownership, such as depreciation and the tax credit.

---

part, on the economics of doing so. The economic viability of these projects as long-term low-income housing is discussed below.

---

## Several Factors May Affect the Housing Actually Delivered Over Time

No matter how carefully the allocating agencies define their housing priorities or control the allocation of tax credits through their allocation plans, several factors have the potential to affect the housing actually delivered over time. First, nearly all of the agencies reserve some discretion for amending or bypassing the process. Second, a significant proportion of the tax credits that have been allocated appear not to have been used as planned, according to our analyses of data from several sources. Finally, the long-term economic viability of tax credit projects as housing for low-income tenants has not been tested.

---

## Some Plans Allow the Allocation Process to Be Bypassed

Seventeen of the 20 qualified allocation plans that we reviewed provide flexibility for overriding or bypassing the allocation process. This flexibility includes removing certain restrictions, such as set-asides, at the end of the year; reserving a portion of the allocation for discretionary awards; and giving designated officials open-ended discretion.

Flexibility can help target needs missed during the allocation process or needs resulting from unforeseen circumstances. For example, in a state where a natural disaster has occurred and housing priorities have changed dramatically, previous allocations may reflect outdated priorities and reallocation at the end of the year may be in order. Even when priorities have not changed, end-of-the-year awards to projects that meet identified needs may be appropriate. Similarly, giving the governor or head of the allocating agency control over a set-aside or other discretionary authority may allow for meeting unforeseen needs.

Unless discretionary awards are reserved for unforeseen needs, are well-documented, and are made public, they may undermine the credibility of the allocation process. Recognizing this potential problem, New York's allocating agency, in August 1996, eliminated a clause in its allocation plan giving the head of the agency the discretion to award over 20 percent of the annual allocation, or \$4.5 million.

Texas' 1995 allocation plan gave senior managers considerable discretion in ranking properties to allocate tax credits. Senior managers could override the staffs' recommendations and award credits to applications with lower scores in order to provide for "geographic dispersion." In all,

- 29 of the 46 projects that received credits originally received lower scores than other projects that did not receive credits, and
- 12 of the projects that received credits were originally classified by the state's underwriters as economically unfeasible.

At management's request, the underwriters subsequently granted "conditional approval" to the project applications, but the applications were never returned to the underwriters for verification that the conditions had been met. Moreover, the managers provided no documentation to show, as required, how their discretionary awards were consistent with state and federal requirements to provide housing to low and very low-income households.

### More Projects Are Allocated Credits Than Are Placed in Service

Our analysis of data—from the states, IRS, and a study contracted by HUD—suggests that the states may not be fully using their tax credit allocations. Under the Internal Revenue Code, the states may award tax credits to projects contingent on their timely completion, i.e., placed in service within two years after the year of the initial tax credit allocation. Available data show a significant gap between the tax credits that have been allocated by the states to proposed projects and the tax credits that have been awarded to projects that have been placed in service.

Our analysis of data from the states shows that for each year from 1992 through 1994, the value of the tax credits awarded to projects placed in service fell substantially short of the total annual per capita allocations. Table 3.1 shows the tax credits the allocating agencies reported as awarded to projects that were placed in service in the continental United States from 1992 through 1994.

Table 3.1: Tax Credits Awarded to Projects Placed in Service, 1992-94

Year	Total tax credits awarded to projects placed in service each year (\$ millions)
1992	\$158
1993	223
1994	229

Source: GAO's analysis of allocating agency data.

The annual per capita allocations total about \$315 million each year. Thus, if all of the credits were awarded to projects that were placed in service,

the value of the credits for projects placed in service should, over time, approximate the per capita allocations. Although the value of the credits awarded to projects placed in service may vary from year to year, it should, on average, come close to the annual per capita allocation if all credits awarded were placed in service. However, as table 3.1 indicates, the value of the credits awarded to projects placed in service fell more than \$80 million short of the annual \$315 million per capita allocation in each of the 3 years. We have not analyzed the reasons for this difference; possible reasons include developers returning their allocations for proposed projects to the states for reallocation in subsequent years or the states awarding less than their full allocation to projects placed in service each year.

To supplement the data presented in table 3.1, IRS performed an analysis for us of the cohort of projects proposed in 1992. The analysis compared the value of the tax credits allocated to projects proposed in 1992 with the value of the tax credits subsequently awarded when projects proposed in 1992 were placed in service. According to IRS' analysis, the 1992 allocations totaled about \$322 million, but only about \$161 million in credits—or about one-half of the total—were actually placed in service as of the end of calendar year 1994.

HUD's contractor also discussed the apparent shortfall in the production of tax credit housing. In a study published by HUD in July 1996, the contractor estimated that from 1987 through 1992, the annual production represented the use of about 60 percent of the available allocation. Because of the potential 2-year lag attributable to construction, the study concluded that the actual "drop out" rate was probably lower than 40 percent, but how much lower was unknown.

These data raise the question of whether the allocating agencies produced the housing that the federal government was prepared to fund. If tax credits have been allocated to proposed projects that are not completed within 2 years as the program requires, the credits can be returned to the allocating agency and reallocated before the end of the second year. The agency then has 2 more years to award the reallocated credits. But if the agency does not reallocate the credits before the end of the second year, the credits would lapse and the agency cannot use them. From the available data, we cannot determine how much of the total federal allocation that has not been awarded may have lapsed and how much may have been reallocated for future use. Unawarded allocations that lapsed would represent lost opportunities to create low-income housing. The



---

difficulties of monitoring reallocated tax credits are discussed in chapter 5.

---

## Extended-Use Commitments Have Not Been Tested

Because no tax credit properties are old enough to have outlived their tax credits, the economic viability of these projects as long-term high-quality housing for low-income tenants has not been tested. As discussed earlier, projects receiving tax credits are now required to have an extended-use agreement requiring that the property serve low-income tenants for 30 years. A contingency clause allows conversion to market-rate housing after 15 years if states cannot find a buyer at a price specified in the Internal Revenue Code willing to keep the property in low-income housing. However, states may impose more stringent extended-use requirements. Indeed, about two-thirds of the projects placed in service from 1992 through 1994 had extended-use commitments that would preclude the possibility of conversion to market-rate housing after 15 years.

Within the next decade, the first properties subsidized with tax credits will enter the period covered by extended-use agreements. Whether these properties convert to market-rate housing, continue to provide high-quality housing for low-income tenants, or gradually deteriorate will depend on the economics of the alternative uses and states' ability to find buyers willing to keep the properties in low-income use.

Some have questioned the economic viability of these properties as low-income housing after the tax credits expire. For example, several experts told us that in their view, the replacement reserves required by RHS will be insufficient to meet future needs for basic maintenance or rehabilitation. According to these experts, the tax credit properties and other multifamily properties financed with RHS loans will need to obtain additional subsidies if they are to remain high-quality, affordable housing units.

---

## Conclusions

All the states had developed qualified tax credit allocation plans, required by the Internal Revenue Code to direct tax credit awards to meet priority housing needs. The plans generally targeted the credits to the priority housing needs identified by the states. Consistent with the latitude given them in the Code, the states had defined and weighted the selection criteria for awarding credits in different ways. There was also considerable variation in their plans in the data and analyses used in

---

assessing housing needs. NCSHA has established a commission to identify ways to improve various aspects of the credit program, including the way allocation plans allocate tax credits.

Although all states had qualified allocation plans, we identified three additional factors that could affect the housing actually delivered over time. First, some states used discretionary judgment in addition to the criteria in the allocation plans in making final credit allocation decisions. Second, IRS and state data indicate that many tax credits that were initially allocated may not have been used. Finally, the economic viability of tax credit projects as long-term, low-income housing has not been tested because projects have not yet been operational beyond the credit period. Determining whether, or how, these factors affect the long-term delivery of low-income housing that meets state housing priorities was beyond the scope of this report.

# Opportunities for Improving States' Controls Over Project Costs

In order to limit the federal share of housing project development costs, the Internal Revenue Code directs the state tax credit allocating agencies to award no more tax credits to projects than necessary for their financial viability. The Code provides some broad guidance on how to limit awards but leaves to the state allocating agencies the responsibility for establishing specific standards and controls.

Our review of tax credit allocating agency implementation of their responsibilities showed that the agencies have established a variety of controls for helping ensure appropriate tax credit awards. These controls vary in their coverage and stringency. For example, some agencies control awards by using cost standards, competition among developers, and independently certified data on projects' sources and uses of funds. On the other hand, some project files that we reviewed lacked complete or independently certified information on the sources and uses of project funds. This is a control weakness that may make allocating agencies vulnerable to over awarding or under awarding tax credits to housing projects.

The variations in controls established by the allocating agencies may provide opportunities for the agencies to learn from each other's experiences about the effectiveness of alternative practices. The state allocating agencies, through their national association (National Association of State Housing Agencies) have periodically reviewed state practices to identify appropriate standards and best practices. They have recently convened a Commission that, among other responsibilities, is to consider ways to improve tax credit administration, including matters discussed in this report.

---

## Tax Code Requirements

The Internal Revenue Code directs that allocating agencies shall not award tax credits to a qualified low-income housing project in excess of the amount determined necessary for housing project financial feasibility and viability as a qualified low-income housing project throughout the tax credit period. The Code specifies the types of information to be considered in making such a determination and the timing of the determinations.

- With respect to information requirements, the Code requires the allocating agencies to consider (1) the sources and uses of funds and total financing planned for the project, (2) any proceeds or receipts expected to be generated as a result of tax benefits, (3) the percentage of the housing

credit dollar amount used for project costs other than the cost of intermediaries, and (4) the reasonableness of the development and operational costs of the project.

- With respect to timing, the Code requires the allocating agencies to consider the required information at the following times: (1) when a project's application is received, (2) when an agency makes a preliminary allocation of tax credits, and (3) when a low-income building is placed in service.

As a practical matter, as discussed with allocating agency officials, the Internal Revenue Code requirements translate into the following three-step tax credit determination process that the states generally should follow in order to help ensure that no more credits are provided to low-income housing projects than necessary.

- First, allocating agencies should make a judgment on the reasonableness of a project's development cost because (1) development cost is a determinant of the financing needs of a housing project, and (2) the maximum tax credit award is based on development cost.<sup>1</sup>
- Second, allocating agencies should make a judgment on a housing project's income-producing potential and non-tax credit financing arrangements because decisions on the amount of private financing that a housing project is capable of supporting affect decisions on the amount of tax credit equity investment (or other public assistance) needed by a project to overcome any deficits in project financing.
- Third, allocating agencies should make a judgment on the investment yield (i.e., the amount of equity investment a project could raise for each tax credit dollar received) obtainable from a project's tax credit award in order to convert tax credits into an equity investment commensurate with a project's financing deficit.

Also, within the rather broad federal directive of providing housing projects with no more tax credits than needed, the allocating agencies are responsible for establishing specific implementing controls, such as standards for determining the reasonableness of project development cost. The use of such standards may enable the agencies to limit the federal tax credits per project and finance more projects out of their tax credit

---

<sup>1</sup>The Internal Revenue Code limits tax credit awards to an annual amount equal to a specified percentage of a project's qualifying development costs that were determined to be reasonable by the allocating agency. The Code originally limited an award to 9 percent of the approved costs of substantial rehabilitation and construction of buildings that are not federally subsidized or 4 percent of the approved costs of acquisition or construction of projects receiving other federal subsidies. IRS is required to periodically revise the rates to reflect current interest rates.

allotment. To assist the states in making such evaluations, NCSHA has recommended the adoption of a number of cost control standards.

Figure 4.1 provides an overview of the costs that the allocating agencies reported were associated with developing and financing the tax credit supported low-income housing placed in service during 1992 through 1994. On the basis of our sample, we estimate that these projects cost about \$10.7 billion to develop: about \$5.8 billion in construction expenses; about \$2.7 billion in construction-related fees, such as those paid to developers and builders; and about \$2.2 billion in other costs, including the costs of acquiring the property. The projects were financed with approximately \$3.1 billion of equity investment raised through the award of tax credits and the remainder largely through commercial loans (mortgages) and publicly supported concessionary financing, such as CDBG loans.<sup>2</sup> Given the yield of the tax credit awards at the time (averaging an estimated \$0.53 of equity investment for each \$1 of tax credits made available to project equity investors over a 10-year period), the states awarded about \$6.1 billion in tax credits to the projects. These awards amounted to an estimated 97 percent of what the allocating agencies determined were the maximum allowable credits that could be awarded to the projects, on a per project basis.

The following three sections describe the controls and standards employed by the states in each phase of the three-step tax credit final award determination process; a process established to help ensure that no more credits are awarded to low-income housing projects than necessary. Recently, NCSHA convened a Commission that, among other responsibilities, is to consider ways to improve tax credit administration, including matters discussed in this report.

---

<sup>2</sup>In addition, the projects received an estimated \$229 million in rent payments subsidized by various rental assistance programs, such as those financed by HUD and RHS.

**Figure 4.1: Estimates on Housing Project Sources and Uses of Funds**

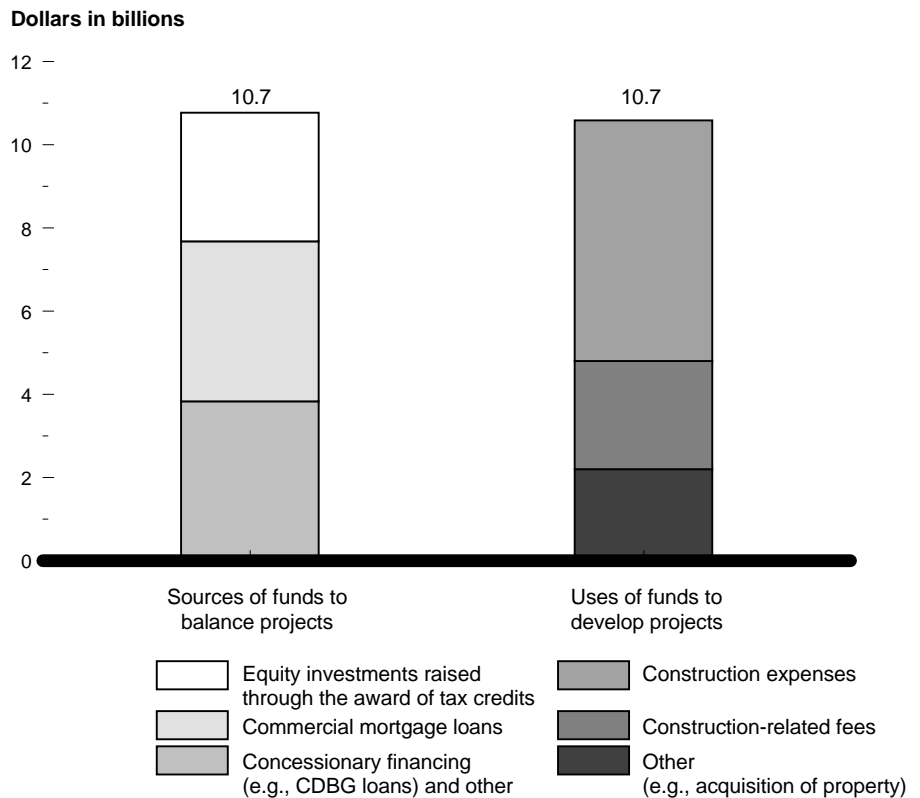

Source: GAO analysis of tax credit allocating agency data on sampled projects with adjustments to account for 14 percent of the projects with incomplete financing information.

## Allocating Agency Practices for Ensuring Reasonable Development Costs

Section 42 of the Internal Revenue Code directs the states to consider the “reasonableness” of housing project development costs when determining the amount of tax credits necessary for project feasibility, but it does not specify how “reasonableness” should be determined. Rather, Congress provided the states with the flexibility to respond to their unique and varied low-income housing needs. As expressed by the congressional conferees in establishing the provision, the states were expected to set standards of reasonableness reflecting the applicable facts and circumstances, including the location of projects and uses for which the projects are built. The conferees also indicated that the provision was not intended to create a national standard of reasonableness.

To assist the states in their administration of the tax credit, in a June 1993 report NCSHA recommended a number of cost control standards for the allocating agencies to consider adopting. The cost control areas covered by NCSHA's recommendations address overall housing unit costs and certain components of overall costs, such as developer fee and consultant fee limits. In October 1995, NCSHA also issued a pamphlet listing a number of tax credit administration "best practices," some of which relate to cost control standards.

In turn, the states have adopted a number of practices to directly control costs (both overall costs and certain components) and to manage competition in a way intended to promote cost control. But the rigor of the controls and the formalized documentation of the controls used by the states vary—in some cases they are more stringent than NCSHA recommended, and in some instances less.

---

## **Standards for Evaluating Overall Development Costs**

In its 1993 report, NCSHA recognized that public support for the tax credit program could be "imperiled by projects, however meritorious, the cost of which exceeds an accepted standard of reasonableness." Accordingly, it recommended that each state develop a per unit cost standard either for the entire state or different standards within the state to account for variations in construction and other costs.

NCSHA's report also pointed out that the baseline standard(s) states develop should, for many areas, be within the limits established for HUD's section 221(d)(3) mortgage insurance program. This program is designed to establish maximum per unit cost limits equivalent to the costs of constructing nonluxury multifamily housing projects for different areas within each state.<sup>3</sup> For market areas and/or project types with higher or lower development costs, NCSHA suggested that the allocation agencies might choose to modify HUD's 221(d)(3) standards, but it recommended that the agencies fully document the reasons for these higher costs in establishing a higher standard. NCSHA further recommended that once a state had adopted or modified the 221(d)(3) cost standards, any proposed project with costs above its standard should be required to fully document the reasons for these costs and subject them to further review and scrutiny.

---

<sup>3</sup>These limits were initially set by Congress in legislation and adjusted annually by HUD to reflect changes in construction costs. The limits provide different maximums according to housing characteristics, e.g., elevator and nonelevator buildings.

Of the 54 allocating agencies we surveyed, 48 agencies reported that they have established guidelines for controlling overall project construction costs. Of these 48 agencies,

- 22 said they employed the dollar-specific limits contained in HUD's 221(d)(3) guidelines,
- 11 said they established their own dollar-specific per unit or per square foot cost limits, and
- 15 said they made reviews without dollar-specific per unit or per square foot limits.

The six allocating agencies that reported not having guidelines said that they relied either on the competition of the application process or on staff expertise as a means of evaluating cost reasonableness.

Allocation agency officials from California said that adopting HUD's 221(d)(3) limits helped them to reduce housing project costs. According to their analysis, the development costs of projects receiving tax credits in 1996—the first year California made use of the 221(d)(3) limits—were 12 percent lower than the development costs of projects receiving credits the year before. The officials attributed this improvement primarily to reductions in “soft costs” (e.g., construction financing and various professional fees), which had escalated before the agency adopted the 221(d)(3) standards.

Other allocating agency officials said that using their own standards was more cost effective than relying on HUD's 221(d)(3) limits. Mississippi allocating agency officials reported, for example, that the agency had developed a maximum per unit cost standard that is lower than HUD's limits. This standard is based on the costs of construction and land in the state and is adjusted to reflect variations in these costs within the state. In addition, the officials said they examined cost data on existing tax credit projects and compared these data with cost data for other nonluxury multifamily buildings in the same geographic areas.

New Jersey relied on its own database to determine the reasonableness of project costs. According to allocating agency officials, the costs of proposed projects are compared with the costs of comparable projects included in the state's database of over 40,000 housing units, and any out-of-line costs must be justified.



Iowa relied on the experience of its staff in evaluating the reasonableness of project costs. According to allocating agency officials, the wide variations in project types, unit sizes, and geographic areas make setting specific dollar limits impractical.

Whether the allocating agencies relied on specified cost limits or less specific criteria such as database analysis, most said they allowed construction costs to exceed their guidelines. Both the instances in which exceptions were allowed and the size of the permitted exceptions varied among the agencies. South Carolina, for example, required no justification for costs that exceeded the state's limits by up to 10 percent but required justification for differences of more than 10 percent. In California, projects were eligible for a 15-percent increase if they had special features, such as linkages with mass transit, facilities for tenants with special needs, or significant seismic upgrading.

---

## **Standards for Evaluating Components of Overall Costs**

In addition to advocating the adoption of a standard for controlling overall development costs, NCSHA recommended that the allocating agencies adopt limits for certain components of overall costs, such as fees for developers, builders, and consultants. Most of the agencies reported that they generally followed NCSHA's recommended limits, while others reported adopting limits that were more or less stringent. Regardless of the standards adopted by the individual agencies, comparisons among agencies are difficult because of differences in how these standards are either defined or computed.

### **Developer Fees**

A developer's fee is meant to compensate a developer for the staff time, entrepreneurial effort, work, and risk involved in the development of a project. NCSHA recommended that the fee should be limited to no more than 15 percent of a project's total development cost unless an agency specified criteria for justifying a higher fee. For example, a larger fee might be justified to induce the development of low-income housing in an area that otherwise would not be served.

All but one agency reported that it had set limits on the developer's fee.<sup>4</sup> For the most part, these limits ranged from 10 to 23 percent—most were 15 percent—but comparisons among the agencies were difficult because of differences in the definition of the cost base on which the limits were

---

<sup>4</sup>According to officials from the agency that has not set limits on the developer's fee, this fee is reviewed for reasonableness and, when it is considered excessive, the agency has the authority to reduce the project's tax credit award.

computed and in the variable nature of some agencies' limits. For example:

- With respect to adopting different cost bases, (1) New Jersey limited the developer's fee to 15 percent of a project's total development costs excluding the costs of land, working capital, marketing expenses, operating deficit reserves, and the syndication costs incurred by the developer; (2) Nevada and North Dakota limited the developer's fee to 15 percent of a project's "eligible basis";<sup>5</sup> (3) Missouri limited the developer's fee to 18 percent of a project's adjusted basis; and (4) West Virginia limited the developer's fee to 20 percent of a project's "adjusted basis," excluding the developer's fee.
- With respect to adopting variable fee limits, North Carolina's agency took project size into account by limiting the fee to 15 percent of the overall development costs for projects with up to 60 units, to 12.5 percent for projects with between 61 and 100 units, and to 10 percent for projects with over 100 units. Other allocating agencies varied the fee to account for other project characteristics, such as setting one limit for construction and another for acquisition, while other states adjusted the limit to account for the attainment of specified objectives, such as the amount of equity investment realized from the tax credit award.

---

## **Fees to Builders and Related Parties**

NCSHA recommended that the allocating agencies set limits on the fees generally charged by builders or general contractors for their work in constructing or rehabilitating housing projects. NCSHA recommended, for example, that unless otherwise justified, the builder's total fee should not exceed 14 percent of a project's construction costs (including 6 percent for profit, 2 percent for overhead, and 6 percent for general requirements).

NCSHA also recommended that the allocating agencies require a developer to disclose any "identity of interest" with any other party to the project and take such interest into consideration in determining the maximum fees. This control could prevent the double payment of some fees, such as overhead charges, to essentially the same party.

---

<sup>5</sup>"Eligible basis" refers to a project's development costs that are chargeable to a capital account for determining depreciation expenses for tax purposes (i.e., "adjusted basis"), with certain modifications as defined in section 42 of the Internal Revenue Code.

The responses to our survey indicate that almost all of the agencies have set limits on the builder's fee.<sup>6</sup> About half of the agencies reported following NCSHA's recommended standards fairly closely, and others introduced variations. For example, Maryland's allocating agency took the characteristics of individual projects into account. Instead of capping the total builder's fee at 14 percent, the agency established a range of fees from 12 to 23, percent depending on a project's construction costs. In contrast, New Jersey had set no fixed standards for the builder's profit, overhead, and general requirements. The allocating agency required review of these costs only if there was an identity of interest between the developer and the builder.

Only one state allocating agency reported that it did not require the identification of an identity of interest. The absence of this information negates the potential for closer scrutiny of costs to ensure they are fully justified and reasonable. But, as a matter of practice, nine state allocating agencies advised us that they did not consider identity of interest when determining maximum fees. For example, District of Columbia officials advised us that the limit is the same regardless of whether the parties are related.

#### Consultant and Professional Fees

To control consulting fees, NCSHA recommended that the states (1) identify professional fees, such as architect and engineer fees, that could be reimbursed from the financing raised by tax credits; and (2) include other consultant fees within the developer fee limit.

All of the allocating agencies reported that in evaluating projects, they require the identification of professional fees. But 11 of the agencies did not require that such fees always be contained within the limit on developer fees.

#### Syndication Fees

As part of the evaluation process used to determine the amount of tax credits needed by projects, the Code requires states to consider the amount of funds (proceeds) to be generated by tax benefits and the portion that is used for project costs other than for intermediaries, e.g., syndicators who raise equity capital for housing projects.

Typically, most of the expenses of syndication are paid by investors to an investment syndicate in the form of a syndication fee, similar to a "load fee" paid to a mutual fund manager. This fee would cover such syndication

---

<sup>6</sup>Agencies that have not set limits may review the builder's fee for reasonableness. According to officials from one agency, if the fee is found to be excessive, the tax credit award may be reduced.

expenses as the marketing of funds contributed to a syndicate, associated legal and accounting costs, management of syndicate funds, monitoring of housing project operations, and funding reserves. Information we obtained from syndicators indicates that syndication fees may consume about 10 to 27 percent of the funds contributed by investors to the syndicate,<sup>7</sup> leaving about 90 to 73 percent available for investment in housing projects.

Syndication expenses may also be paid by housing project developers. These may include legal and accounting fees and other expenses associated with arranging for the equity investment. Typically, these costs would be minor compared to syndication fees.

Although much of the syndication expenses would be passed on to housing projects in the form of reductions in the amount of equity investment available to the project, NCSHA has not established a recommended cost limit for those syndication expenses. NCSHA has, however, recommended that if costs that are properly payable by a syndicator (such as those associated with securities registration and sales commissions) appear as development costs of a project, the costs should be disallowed. In turn, the agencies have tended to focus on housing project development costs and, as discussed later, the results of the syndication process (see section on tax credit pricing). More specifically, although 38 agencies advised us that they reviewed syndication costs that were an expense of the housing project, only 11 advised us that they reviewed fees the syndicators charge their investors. As explained by one allocating agency, it reviews the sources and uses of funds for the project (a review required of all allocating agencies by the Code) but not the sources and uses of funds of the syndicators.

---

## **Competition as a Control Over Project Costs**

Competition among developers for tax credits is another control over project costs. Of the 51 allocating agencies that could provide data on the number of housing project developers that applied for tax credits in 1995, all reported turning down applicants. Overall, about 54 percent of the applicants were not successful in competing for tax credits in 1995. But this competition is not uniform among the states; a few allocating agencies turned down less than 20 percent of the 1995 applicants.

---

<sup>7</sup>Syndication fees are affected by the manner in which the capital is raised. In general, syndication costs are higher for capital raised through public offerings to individuals than for capital raised through private placements with large corporations. According to syndicators, the costs of registration with the Securities and Exchange Commission and brokerage commissions make public offerings more expensive than private placements.

Our review of 20 state allocation plans showed that most adopted procedures for managing this competition in a way that supplements cost control limits. They adopted scoring formulas for ranking housing projects based in part on cost considerations. For example, out of a possible score of 164 points in one state's ranking system, 20 points were to be awarded to the project determined to be the least costly in terms of per unit development cost and tax credits sought. Other more costly projects were to receive less than 20 points. Overall, the higher the total points earned by a project, the greater the likelihood of receiving a tax credit award.

Allocation officials in New Jersey said that they obtained benefits by incorporating cost considerations into their scoring formula. The officials told us that even though the state had established a 15-percent limit on developer fees, since the state started awarding points for lower fees, the developer fees have dropped to an average of about 8 percent of allowable development costs.

---

## **Allocating Agency Practices for Determining Project Equity Needs**

After giving consideration to the reasonableness of a project's development costs, allocating agencies are to determine a project's financing deficit, i.e., the amount of development costs that a project is not capable of financing through its own operating revenues. The subsequent tax credit award should be no greater than an amount needed to attract an equity investment commensurate with the financing deficit.

In making judgments on a project's financing deficit, the Internal Revenue Code requires the allocating agencies to evaluate both the sources and uses of funds (including the reasonableness of a project's operating costs) and the total financing planned for the project. However, the Code does not specify how the evaluation is to be done, nor has NCSHA recommended standards to be followed.<sup>8</sup> Hence, the agencies are responsible for developing their own procedures and practices for implementing the Code's requirements.

In general, the allocating agency officials told us that their staffs

- reviewed the reasonableness of a project's estimated revenues (e.g., rent) and operating expenses (e.g., maintenance) to determine how much income should be available to cover the project's private financing;

---

<sup>8</sup>Although it did not promulgate standards, NCSHA recommended, in its 1995 pamphlet on best practices, that the allocating agencies develop a database on project development and operating costs for use in evaluating proposals for financial feasibility and determining the tax credit awards that projects are eligible to receive.

- assessed the reasonableness of the private financing arrangements relative to the terms (e.g., interest rate charged) of that financing and to the income anticipated from the project to carry the private financing; and
- reviewed the total financing for the project, including tax credits and any other public subsidies needed to supplement the private financing in order to make the project financially feasible.

As the following sections indicate, the allocating agencies used different standards and practices to assess reasonableness, and not all of the agencies assessed all aspects of reasonableness.

---

### Agency Procedures for Assessing Project Income

All of the 54 allocating agencies reported checking the reasonableness of a project's rental income. The most common means of checking were as follows:

- 53 agencies said they reviewed the expected vacancy rate over the 15 year tax credit period;
- 48 agencies said they reviewed the anticipated rate of increase in rental income over the 15 year tax credit period; and
- 31 agencies said they reviewed the estimated absorption rate (number of months needed to lease all of the units in the project).

The most common sources of data for these checks were market studies done by the developer (44 agencies), agencies' databases (34 agencies), property appraisals (24 agencies), and market studies done by the allocating agency or another governmental agency (21 agencies).

All but 5 of the 54 allocating agencies reported that they maintained data for use in assessing the reasonableness of a project's operating costs. Two-thirds maintained their own database on multifamily housing, and the others relied primarily on state or regional cost indexes or other specifically developed data such as that developed by lenders. For the most part, the agencies reported using these data to establish a cost standard based on a specified dollar per unit per month (or per year) or calculated as a percentage of operating revenues. But these standards were not necessarily rigid limits. Almost all of the agencies allowed a project's operating costs to exceed the standards, if warranted.

---

### Agency Standards for Assessing Private Financing

All but 8 of the 54 allocating agencies reported having written guidelines to assist their staffs in determining the reasonableness of a project's private financing and the amount of such financing that a project can support. The

most common procedures adopted by the agencies for checking reasonableness, regardless of whether they were written or not, were the following:

- Forty-nine agencies said they reviewed a project's debt service coverage ratio. This commonly accepted measure for evaluating a rental project's financing is computed by dividing the project's net income (e.g., rental revenue less operating expenses) by the mortgage payment. The higher the ratio, the less the project's income is committed to financing the project through its mortgage loan. Conversely, the lower the ratio, the more the project's income is committed to the financing and is unavailable for other purposes. Most of the responding agencies reported that they had set a maximum rate (ranging between 1.15 and 1.50) and a minimum rate (ranging between 1.05 and 1.20) for this ratio.
- Forty-eight agencies said they reviewed the interest rate charged on a project's mortgage loan. In general, the higher the interest rate, the lower the debt that a project can support and, therefore, the greater the project's need for tax credit equity investment. Because interest rates change periodically, we did not ask the agencies for information about their limits on them.
- Forty agencies said they reviewed a project's mortgage loan amortization period (i.e., the period over which a loan is scheduled to be repaid). In general, the shorter the amortization period, the higher the periodic loan payment. Higher payments reduce the amount of debt that a project can carry over the short term and, therefore, increase the project's need for tax credit equity investment. Most of the agencies with limits on the amortization period set them for between 15 and 30 years.<sup>9</sup>

**Table 4.1: Size of Mortgage Deemed Supportable Under Alternative Debt Service Coverage Ratios and Amortization Periods**

Interest rate	Debt service coverage ratio	Amortization period		
		30 years	20 years	15 years
10 percent	1.10	\$1,338,000	\$1,217,000	\$1,093,000
	1.25	\$1,177,000	\$1,071,000	\$ 962,000
	1.40	\$1,051,000	\$ 956,000	\$ 856,000

Note: The analysis is based on the following assumptions: a 50-unit property that costs \$3 million to develop and generates \$155,000 in annual operating income. Dollar amounts are rounded to thousands.

Source: GAO analysis.

<sup>9</sup>To illustrate the impact of differences in debt service coverage ratios and amortization periods, we performed a sensitivity analysis showing the effects of alternative ratios and periods on the size of a mortgage. As table 4.1 shows, changes in these variables can significantly affect the mortgage amount that net operating income may be deemed sufficient to support.

- 
- Twenty-six agencies said they reviewed a project's mortgage loan balloon payment period (i.e., the period over which the loan principal may become due, which would occur before the end of the amortization period). In general, balloon payments add to the long-term financial uncertainty of a project because they require future refinancing. Most of the responding agencies reported that they had set limits on the balloon payment period at 3 to 15 years. As a best practice, however, NCSHA discouraged balloon payments, recommending that the allocating agencies give priority to developments with mortgage commitments of at least 15 years.

---

## Reviews of Other Public Subsidies

The Code directs the allocating agencies to evaluate the total financing for a project, including all of the public subsidies as well as the private financing. This evaluation is necessary because public subsidies may affect the size of the tax credit award<sup>10</sup> and also because the maximum allowable tax credit award may not be sufficient to cover a project's financing deficit. Additional subsidies from federal, state, or local sources may be needed, for example, when a project's rents have been set very low to serve households with very low incomes or when costly features have been included in a project to meet special needs. The Code's requirement for an evaluation of all subsidies is designed to prevent both overfunding and underfunding of the assisted projects.

All the allocating agencies told us that they considered the reasonableness of the overall sources of funds committed to a housing project. The data on the tax credit projects placed in service between 1992 and 1994 showed that the majority benefited considerably from subsidies in addition to tax credits. On the basis of our sample, we estimate that about 69 percent of these projects received about \$3 billion in concessionary loans (e.g., below market interest rate loans) or grants. Table 4.2 sets forth the sources of financing for these projects.

---

<sup>10</sup>See footnote 1, page 74.



**Chapter 4  
Opportunities for Improving States' Controls  
Over Project Costs**

**Table 4.2: Estimated Sources of Financing for Projects Requiring Subsidies in Addition to Tax Credits**

Source of financing	Percentage of financing
Concessionary loans/grants	37
Tax credit equity	27
Mortgage loans (commercial)	29
Other	6
<b>Total</b>	<b>100</b>

Note: Total does not add because of rounding.

Source: GAO analysis of allocating agency reported data.

Much of the concessionary assistance provided to tax credit projects is federal—such as loans through RHS, CDBG, and HOME. These types of housing assistance, some of which are administered by the states, have their own requirements for evaluating all public and private financing sources to ensure that no more assistance is provided than necessary. For financing provided through HUD, the required evaluation is called a “subsidy layering review.”<sup>11</sup>

Besides concessionary loans and grants, tax credit projects may receive funds through rental assistance programs. Rental assistance may be project based (generally provided under a long-term contract between HUD or RHS and a housing project) or tenant based (provided through a certificate or voucher for a qualifying household). On the basis of our sample, we estimate that the tax credit projects placed in service during 1992 to 1994 received about \$229 million a year in project-based and tenant-based rental assistance payments, increasing the total proportion of housing projects receiving assistance beyond tax credits to 86 percent.<sup>12</sup>

We did not review the controls established by the other federal housing assistance programs for limiting their subsidies to tax credit projects. But, as indicated by the following two examples, the information we obtained from the allocating agencies suggests that allocating agencies have adopted varying practices in integrating the other assistance into the tax credit review process.

<sup>11</sup>Congress originally established the subsidy layering review requirement in the HUD Reform Act of 1989. Although we discussed this requirement with officials from HUD and the allocating agencies, the scope of our review did not include the implementation of these requirements.

<sup>12</sup>This estimate is based on the monthly rental charges for 1996 reported by the projects in our sample. A property is included in the estimate if at least one tenant received a rental subsidy.

- First, a tax credit project may attract tenants who qualify for federally financed tenant-based rental assistance. As indicated in chapter 2, rents charged in accordance with the assistance program rules may exceed the tax credit rents charged unassisted tenants. According to our survey of allocating agencies, 12 of the 54 agencies have taken steps to preclude this from happening. Thus, more assistance could be made available for other households. The remaining 42 agencies may either (1) allow affected projects to retain the differential; or (2) require the project to return the differential to the state by, for example, using it to help retire a concessionary loan from the state. The relative frequency of each outcome was not measurable from the data obtained from the housing projects.
- Second, the Code authorizes the states to provide tax credits to housing projects that are financed through the issuance of tax-exempt bonds. For projects that receive at least 50 percent of their financing in this way, the Code authorizes the awards to be made outside of state tax credit allotments.<sup>13</sup> In other words, the bond projects do not have to compete against the projects vying for a portion of the annual \$1.25 per capita tax credit allotment. A total of about \$10 million in tax credits was awarded outside the tax credit ceiling in 1995. Although the projects receiving these awards are subject to other requirements under the Code—for example, they are eligible for no more tax credits than are necessary for their financial feasibility subject to the limits established for federally subsidized projects—their finances may not always be evaluated with the same rigor as those of projects competing for a portion of the per capita allocation. Officials in New Jersey told us, for example, that for tax-exempt bond projects, the developer's fee is typically the full 15 percent allowed by the allocating agency. For other tax credit projects, the developer's fee has been reduced through competition to 8 percent.

---

## State Controls Over Tax Credit Pricing

After determining a project's financing deficit, allocating agencies are to calculate the amount of the tax credit award. The award may not exceed an amount that would produce an equity investment equal to a project's financing deficit or the statutory limit, whichever is less.<sup>14</sup> Because the equity investment yield of tax credits may vary, the allocating agencies need to have assurance that the appropriate yield figure is used in computing the amount needed to produce an equity investment

---

<sup>13</sup>Also, for projects receiving less than 50 percent bond financing, the Code authorizes the states to provide tax credits outside of the tax credit ceiling on the bond financed portion of the housing projects.

<sup>14</sup>As discussed earlier, the limit is based on a percentage of qualifying development costs. The percentage may vary depending on the type of development (acquisition or construction-rehabilitation) and the presence of federal subsidies.

commensurate with the financing deficit. In short, the higher the equity investment yield of tax credits, the lower the amount of tax credits that would need to be awarded to a project.

Neither the Code nor NCSHA provides standards for evaluating tax credit yield. The general measure used by the allocating agencies to quantify yield is "tax credit price" defined as the total amount of equity investment made in a project in relation to the tax credits awarded to the projects, i.e., the sum of credits allowable over the 10 year credit period. The price is expressed as the number of cents of equity investment produced by each \$1 of tax credits awarded to a project. The difference provides the investors with a risk-based rate of return financed over 10 years as well as compensation for housing project evaluation and monitoring.

All the housing credit agencies reported that they generally use one or more evaluation techniques to determine the reasonableness of tax credit prices. They indicated that they mostly rely on market competition to set the price; 53 of the agencies require housing projects to show evidence of multiple competitive bids from investment syndicators or other investors. Additionally, 45 allocating agencies indicated that they use a price benchmark, an evaluation standard generally based on periodic surveys of syndicators or analysis of prior year experience.

Although we did not evaluate how well the agencies applied their evaluation techniques to determine the reasonableness of tax credit prices, our discussions with allocating agency officials and their advisors identified limitations to using tax credit price as a measure of tax credit yield. The timing of the actual capital infusion into a housing project has a material effect on yield, but this may not be taken into account in the way tax credit price is computed. Accordingly, the tax credit price may not provide an ideal measure for states to use for evaluating the equity investment alternatives available to a project.

In addition to the timing of the equity contribution, which may affect the price of the credit, industry experts identified a number of other conditions that could influence tax credit price. For example, given the differences in the cost of raising investment capital, a project receiving its equity investment from a private placement with a sole corporate investor should receive a higher price than that offered by an investment syndication through a public offering. Also, properties generating substantial tax losses (tax deductions to the investors) in addition to the tax credit may command a higher equity price. On the other hand, the

experts indicated that real estate risks, such as locating a property in an unstable neighborhood or having an unproven developer, may reduce the price.

Despite the limitations of using price as an indicator of tax credit yield, at the present time, no other overall measure exists to evaluate tax credit yield, make comparisons among projects, or assess developments in the tax credit market.

**Tax Credit Price Experience**

Even though allocating agencies and syndicators refer to equity investment in terms of "price," no published data sources provide a comprehensive record of tax credit pricing over the life of the tax credit program. Based on our sample of properties placed in service from 1992 through 1994, we estimate that the average price was about \$0.53, with significant variation among the projects. (See table 4.3.)

**Table 4.3: Estimated Distribution of Equity Prices Received for Properties Placed in Service, 1992-1994**

Equity price	Overall distribution 1992-1994
less than \$0.40	9
\$0.40 to \$0.49	39
\$0.50 to \$0.59	32
\$0.60 to \$0.69	10
\$0.70 or more	8

Source: GAO analysis of tax credit allocating agency reported data on 86 percent of the projects, i.e., those with complete information.

In discussions with several major investment syndicators and allocating agency officials, we were told that tax credit prices have been increasing. These sources, and recent surveys of tax credit prices, indicated that for each dollar of tax credits awarded, the average price increased from around \$0.45 in 1987 to over \$0.60 in 1996. They attributed the increase to the following factors:

- The types of investors have changed, from individuals to corporations. Because large publicly traded corporations are not subject to the passive investment loss rules that limit individual investors' and closely held corporations' deductions, tax credit properties represent a relatively more attractive investment option for corporations.

- The types of corporations purchasing tax credits have changed from manufacturing corporations to corporate investors that better understand, and are therefore in a better position to value, the risk of a tax credit investment.
- The types and structures of syndications have changed from public offerings characterized by sales to individuals to private placements characterized by sales to a small number of corporations. These changes have reduced the costs of raising capital.
- The tax credit program was made permanent in 1993, reducing investors' uncertainty over the future of tax credit investments.
- States and localities have established their own equity funds to raise investment capital for low-income housing projects. This has helped to increase competition in the syndication process.
- Growth in the economy and in corporate profitability has increased the taxable income that could be sheltered by tax credits.

---

## Effectiveness of Cost Controls Depends on Accuracy of Cost Data

In controlling federal costs—that is, in evaluating the reasonableness of a project's development costs, financing deficit, and tax credit proceeds—allocating agencies are largely dependent on information submitted by developers on their sources and uses of funds. In summary, allocating agencies need information on the amount of a project's (1) total development costs so that an agency can make informed decisions on the reasonableness of the costs and the amount of financing a project will need; (2) development costs that qualify for inclusion in the tax credit cost base—defined as eligible basis by the Code—so that an agency can compute a maximum tax credit award; (3) financing arrangements, together with the terms of the financing, so that an agency can determine a project's financing deficit; and (4) tax credit proceeds so that an agency can ensure that no more credits are awarded than necessary to cover a project's financing deficit. If the agencies do not have complete information on these sources and uses of funds, they cannot be assured that their controls are effective at controlling federal costs.

In addition, the allocating agencies need assurance about the reliability of that information. Engaging a public accounting firm to validate financial information is a generally recognized practice for ascertaining financial information reliability. When contracting with an independent public accountant, allocating agencies have several options concerning the extent of the work to be performed. These options include (1) an examination or audit, which would provide a reasonable basis for an independent public accountant to issue an opinion on the overall reliability of a project's

financial information taken as a whole; (2) a review, which consists of inquiries and application of analytical procedures that may bring to the accountant's attention significant matters affecting a project's financial information but does not provide assurance that the accountant will become aware of all significant matters that would be disclosed in an audit; and (3) agreed-upon procedures, which would provide an accountant with a basis to issue a report of findings based on the specified procedures but not a basis to issue an opinion on the reliability of the financial information.

Given the importance of having reliable information as a basis for decisionmaking, NCSHA recommended that before finalizing a project's tax credit award, an allocating agency should require a verification of the project's costs by an independent public accountant (or other third-party qualified professional).<sup>15</sup> NCSHA did not, however, specifically recommend the type of public accountant engagement or independent third-party verification of a project's funding sources and tax credit proceeds. But in its 1995 pamphlet on best practices, NCSHA indicated that although the Code does not specifically require the verification of financing sources, allocating agencies should require that the provider and the amount of all financing sources or terms be certified by the housing project owners.

All but 1 of the 54 allocating agencies reported requiring independent cost verifications. To determine (1) who performed the reviews and (2) how much work was done to validate the projects' development costs, we randomly selected a subsample of 48 projects. We found the following:

- For 41 of the 48 projects, the development costs were verified by third parties: 35 by independent public accountants and 6 by state, county, or federal agencies. For the remainder, three were not required by the agency to submit verified cost statements, and four were certified by the developer or general partner instead of verified by independent third parties.
- For the 35 projects that were reviewed by independent public accountants, the costs were validated to varying degrees. The cost verifications for 18 projects were based on an examination engagement, and the verifications for 10 projects were based on more limited but agreed-upon procedures. For seven projects the independent public accountant performed other services.

---

<sup>15</sup>In its 1993 publication on cost control standards, NCSHA recommended that independent third-party cost certifications be required for projects with 25 or more units. In its 1995 pamphlet on best practices, NCSHA recommended that the allocating agencies require certifications for projects of all sizes.

With respect to the overall information needs of the allocating agencies, we could not clearly discern the extent to which the independent public accountants' reports fully addressed those needs. Although the 35 reports required by the allocating agencies that we reviewed had a cost focus, only 19 indicated work directed at validating the costs that qualify for inclusion in the tax credit cost base, i.e., eligible basis. Also, 13 of the 35 reports appeared to cover additional aspects of project financing, such as loan information and syndication agreements.

To test the reliability of the financial data available to the allocating agencies, we reviewed information that they had obtained for our random sample of 423 housing projects placed in service from 1992 through 1994.<sup>16</sup> Extrapolating from our sample, we estimate that 14 percent of the housing projects received tax credits on the basis of inadequate financial data, i.e., the allocating agency records showed that project financing was out of balance with project cost by 5 percent or more. The principal reason for this imbalance was the lack of information in allocating agency records on the equity investment raised through tax credit awards.

Accordingly, given the range of third-party validation practices required by the allocating agencies and the variations in the types of information obtained by the allocating agencies, agencies did not necessarily have assurance as to the reliability of the information needed to make tax credit decisions. According to an accounting firm with a tax credit specialty, the cost for tax credit certifications (opinion on total costs, eligible basis, and tax credit amount) prepared on the basis of an audit done in accordance with AICPA audit standards would be in the \$5,000 to \$7,500 range per engagement, even for projects costing upwards of \$5 million to \$10 million.

---

## Conclusion

In implementing their responsibilities for controlling the amount of tax credits provided to low-income housing projects, allocating agencies need to make three critical judgments. First, they need to make a judgment concerning the reasonableness of development costs because they are to award no more credits to a project than a specified percentage of certain agency-approved project development costs as defined by the Code. Second, given their cost reasonableness decisions, agencies need to make a judgment on the financing arrangements made by a housing project

---

<sup>16</sup>We asked the allocating agencies to provide the final data on costs and financing used to complete their evaluation of the placed-in-service projects.

because the agencies are required to base a tax credit award on the financial need of a project subject to the limit computed on agency-approved development costs. And third, they need to make a judgment on the pricing of the credit, i.e., use an appropriate rate to convert credits into an equity investment amount.

Our review of the controls established by the allocating agencies to make these judgments showed that the agencies have adopted a variety of measures. These variations in agency controls may provide opportunities for the agencies to learn from each other's experiences about the effectiveness of alternative practices. To this end, the state tax credit allocating agencies, through their national association (National Association of State Housing Agencies), have periodically reviewed state practices to identify appropriate standards and best practices. They have recently convened a Commission that, among other responsibilities, is to consider ways to improve tax credit administration, including matters discussed in this report.

Nevertheless, in controlling costs—that is, in evaluating the reasonableness of a project's development costs, financing deficit, and tax credit proceeds—allocating agencies are largely dependent on information submitted by developers. If the agencies do not have complete or accurate information, they cannot be assured that their controls are effective. Although our study was not designed to produce estimates of overfunding or underfunding of housing projects, we did identify areas where the allocating agencies may be vulnerable to making misjudgments given the information available to them in terms of completeness and reliability.

- First, with respect to cost-related decisions, we found that the range of independent cost verification practices varied, and the resulting reports did not always address the amount of project development costs that may qualify, subject to allocating agency approval, for inclusion in the base for computing the maximum tax credit award.
- Second, with respect to financing decisions, we found that there was no independent verification requirement for reconciling sources of project funds with project costs, and, for an estimated 14 percent of the housing projects, the allocating agency information on project sources and uses of funds was out of balance by 5 percent or more.
- Third, with respect to tax credit pricing decisions, we found that the principal reason for the sources and uses of funds imbalance was that the allocating agencies lacked information on the equity investment raised through tax credit awards.



---

Without assurance of reliable and complete cost and financing information, the allocating agencies are vulnerable to providing more (or fewer) tax credits to projects than are actually needed.

---

## **Recommendation to the Commissioner of Internal Revenue**

To ensure reliable and complete information for making decisions on tax credit awards, we recommend that the Commissioner of Internal Revenue amend tax credit regulations to establish clear requirements to ensure independent verification of key information on sources and uses of funds submitted to states by developers.

---

## **Federal Agency and State Association Comments and Our Evaluation**

In commenting on this report, IRS advised us that it agreed with the recommendation and would proceed to determine how best to implement it.

NCSHA, in commenting on the report, expressed concern about “bias and prejudice” because the report implies that state deviations from Council-recommended best practices are deficiencies. In response, we note that the report repeatedly points out that the states were given flexibility in the administration of the program. The introduction to the chapter specifically states that “The Code provides some broad guidance on how to limit awards but leaves to the state allocating agencies the responsibility for establishing specific standards and controls.” Moreover, with respect to our recommendation for IRS to develop regulations requiring the verification of sources and uses of funds, we made this recommendation to better enable the states to comply with the statutory requirement that they consider the sources and uses of funds before awarding tax credits—a check that had not always taken place.

Also, NCSHA indicated that our recommendation did not take cost-effectiveness into account. We disagree. We recognize that costs associated with implementing our recommendations should always be a concern, and we developed the recommendation with that in mind. In recommending that IRS establish requirements for ensuring independent verification of information on sources and uses of funds, we considered a range of options and estimated costs for obtaining such verification.

# Opportunities Exist to Improve State and Federal Compliance Oversight Activities

---

The Internal Revenue Code provides for dual oversight of the tax credit between tax credit allocating agencies and IRS. In general, we found that not all allocating agencies fulfilled the requirements of their compliance monitoring programs; and, although IRS has been developing programs, it did not have sufficient information to determine state or taxpayer compliance.

In general, states are responsible for monitoring project compliance with rent, income, and habitability requirements after the projects are placed in service and for reporting any incidence of noncompliance found to IRS. IRS is responsible for issuing tax credit regulations establishing state monitoring procedures and for ensuring that the states include valid monitoring procedures in their qualified allocation plans. It is also responsible for ensuring that taxpayers claim only those housing credits to which they are entitled and that states do not exceed their annual tax credit allocation ceilings.

Figure 5.1 shows the interrelated nature of the federal/state oversight responsibilities and the reporting mechanisms that are in place to support the effort.

**Chapter 5**  
**Opportunities Exist to Improve State and**  
**Federal Compliance Oversight Activities**

**Figure 5.1: Tax Form Flow and Oversight**

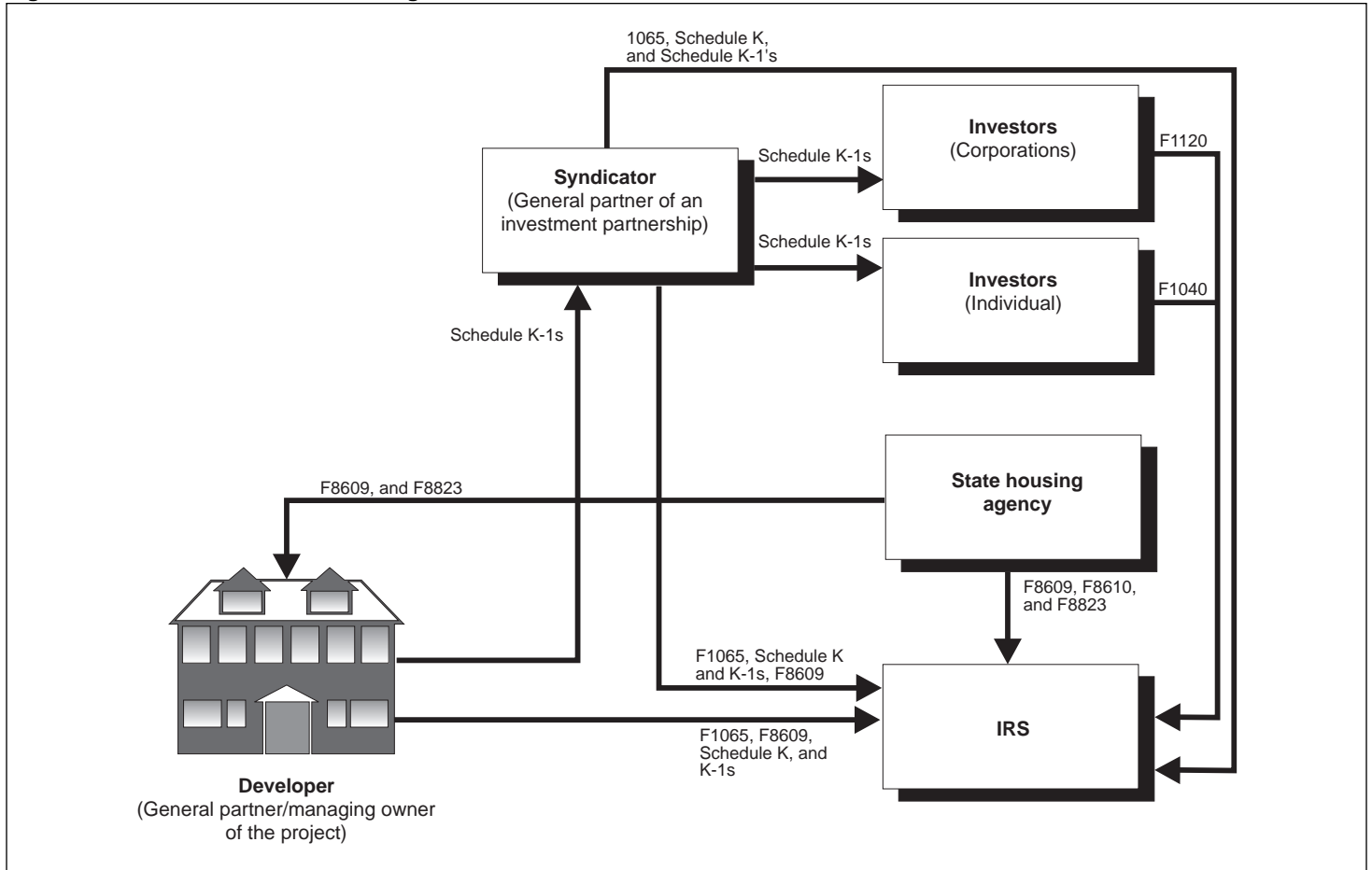

(Figure notes on next page)

---

**Chapter 5**  
**Opportunities Exist to Improve State and**  
**Federal Compliance Oversight Activities**

---

Legend:

**Schedule K - Partners' Shares of Income, Credits, Deductions, etc:** The partnership uses Schedule K to report the partnership's income, credits, deductions, etc.

**Schedule K-1 (Form 1065) - Partner's Share of Income, Credits, Deductions, etc:** The partnership uses Schedule K-1 to report the partners' share of the partnership's income, credits, deductions, etc.

**Form 1040 - U.S. Individual Income Tax Return:** Form 1040 is used by individuals to file their annual tax returns.

**Form 1065 - U.S. Partnership Return of Income:** Form 1065 is used by taxpayers to file their partnership income tax returns.

**Form 1120 - U.S. Corporation Income Tax Return:** Form 1120 is used by corporations to file their income tax returns.

**Form 8609 - Low-Income Housing Credit Allocation Certification:** Form 8609 is used by allocating agencies to notify IRS and a project owner of a tax credit award. A copy is also attached to a project owner's tax return.

**Form 8610, Annual Low-Income Housing Credit Agencies Report:** Form 8610 is used by allocating agencies to transmit Form(s) 8609 to IRS and to report the dollar amount of housing credit allocations issued during the calendar year.

**Form 8823 - Low-Income Housing Credit Agencies Report of Noncompliance:** Form 8823 is used by allocating agencies to notify IRS of a building that is not in compliance (or returns to compliance) with low-income housing tax credit regulations.

Source: GAO discussions with IRS.

All states reported to us that they had adopted compliance monitoring procedures that met or exceeded the requirements established by IRS. However, in 1995, several states did not do as many desk reviews or on-site inspections as they reported were included in their qualified allocation plans. IRS regulations do not require states to report on all their monitoring activities, so IRS has no means for determining whether agencies are meeting their monitoring requirements. Also, IRS' monitoring regulations do not require states to make on-site inspections of projects or obtain building code violation reports from local government units. Therefore, states that do not make on-site inspections or get local building code violation reports are unlikely to detect building code violations that affect project habitability.

Most states had reported instances of noncompliance to IRS, but IRS' proposed revision to the noncompliance form does not provide for the states to indicate the number of units that were out of compliance by specific types of noncompliance, such as tenant income exceeding

eligibility requirements. Without this information, IRS cannot determine whether the noncompliance warrants recapturing tax credits from project owners.

IRS recently initiated tax credit compliance activities to detect noncompliant taxpayers. IRS does not know the extent of taxpayer noncompliance with the housing credit but believes that its audit program, which began in 1995, will provide IRS with sufficient data to make an estimate. At the time of our review, few audits had been completed; thus, it was too early to assess the audit program's effectiveness. Also, IRS' computerized program to match state tax credit information to credits reported on partnership returns was still under development at the time of our review. Similarly, IRS was still developing a computerized system for monitoring allocating agencies' compliance with Internal Revenue Code restrictions on the total number of credits that may be used in one year.

Although both states and IRS conduct various tax credit oversight activities, there is no federally required oversight on the adequacy of state agencies' controls for meeting tax credit requirements. Recently completed state audits of two state credit agencies found several weaknesses in the agencies' controls that indicate that there may be a need for some sort of independent oversight. One option to improve oversight would be to include the tax credit program within the scope of the Single Audit Act Amendments of 1996 (Single Audit Act). The single audit process is an important accountability tool for the federal government in providing oversight for hundreds of billions of dollars of federal financial assistance provided annually to state and local governments and nonprofit organizations. A single audit involves, among other things, tests of the audited entity's controls over compliance with federal laws and regulations. However, neither the Single Audit Act nor implementing guidance issued by OMB includes tax credits in the definition of federal financial assistance.

---

## Opportunities to Improve State Oversight

All states reported to us that they had established monitoring procedures in their qualified allocation plans that were in compliance with IRS' project monitoring regulations. However, several states reported that they did not meet the requirements of IRS' monitoring regulations in 1995.

IRS allowed states to adopt monitoring procedures that did not call for making on-site inspections of projects or for obtaining reports of building code violations from local government agencies that perform building

inspections. On-site inspections or local building inspection reports are necessary for states to determine whether the projects meet the habitability requirements in the Internal Revenue Code.

Most states reported to us that they were complying with IRS requirements to submit reports on noncompliance that they found during their monitoring. However, many states indicated that IRS did not provide sufficient guidance on the types of noncompliance that are reportable. Also, many states reported that they go beyond federal monitoring requirements when state funds are involved in the projects. Also, in addition to monitoring for project compliance, most states said they try to educate owners on how to stay in compliance with tax credit rules.

---

**All State Agencies Had Monitoring Procedures That Met IRS Requirements, but Some States Did Not Follow Their Procedures**

Since June 30, 1992, for state agencies to have a qualified allocation plan, they must include a procedure for monitoring tax credit projects to determine if the projects are in compliance with tax credit program requirements. IRS regulations require state agencies to annually review project owners' certifications that their projects met all low-income housing statutory requirements, such as serving the minimum number of low-income residents; ensuring project habitability in terms of local health, safety, and building codes; and ensuring that each low-income unit was rent-restricted. In addition to reviewing all owner certifications, state agencies were required, at a minimum, to review tenant income certifications and rent charges of projects under their jurisdiction using one of the following three monitoring options:

Option 1: Obtain from owners and review the annual income certifications for at least 50 percent of the projects, including the documentation supporting the certifications and tenant rent records in at least 20 percent of the low-income units in these projects.

Option 2: Make annual on-site inspections of at least 20 percent of the projects, and review the low-income certifications, the documentation supporting the certifications, and rent records for each tenant in at least 20 percent of the low-income units in those projects.

Option 3: Obtain from all project owners tenant income and rent records for each low-income unit and, for at least 20 percent of the projects, review annual tenant income certifications, backup income documentation, and rent records for each low-income tenant in at least 20 percent of the low-income units in those projects.

**Chapter 5  
Opportunities Exist to Improve State and  
Federal Compliance Oversight Activities**

In the information the 54 state agencies provided us, all reported they had project monitoring programs that complied with IRS regulations. As shown in table 5.1, 48 of the 54 state agencies (about 90 percent) reported that in 1995 they met or exceeded the minimum monitoring requirements; the remaining 6 agencies reported they did not do as many on-site or desk reviews as required by the monitoring option they reported that they used.

**Table 5.1: Number of State Agencies That Either Met, Exceeded, or Failed to Meet IRS' Monitoring Requirements in 1995**

Option	Conducted either desk or on-site reviews <sup>a</sup>	Conducted both desk and on-site reviews	Did fewer reviews than required	Total number of state agencies
1		1		1
2	6	28	5	39
3	3	10	1	14
<b>Totals</b>	<b>9</b>	<b>39</b>	<b>6</b>	<b>54</b>

<sup>a</sup>The state agencies using option 2 conducted only on-site reviews, and the agencies using option 3 conducted only desk reviews.

Source: GAO analysis of state agency questionnaires.

IRS' monitoring regulations require states to submit reports on any noncompliance found during desk reviews or site visits. However, IRS does not require states to submit reports on their monitoring activities that show the number of projects and units inspected each year. This information is important because, under the Internal Revenue Code, in order for a state to have a qualified allocation plan it must include a monitoring procedure that satisfies IRS' monitoring regulations. Further, under the Code, a state cannot allocate credits unless it has a qualified allocation plan.

Just having a monitoring procedure in the qualified allocation plan does not necessarily mean that a state follows that procedure. As noted earlier, we found that six states did not follow their monitoring procedures in 1995. Congress enacted the monitoring requirement as a means of ensuring that tax credits were going to projects that qualified for the credit throughout the 15 year tax credit compliance period. One way for states to know whether projects remain qualified for tax credits is for the states to carry out their monitoring procedures. Similarly, for IRS to know whether a state meets IRS' monitoring requirements, it needs some sort of report from the state on the number of monitoring inspections made. IRS could then

compare these numbers with the number of inspections that should be made under a state’s monitoring procedure in its qualified allocation plan.

An annual report on state monitoring activities that simply shows the number and types of inspections made (i.e., desk reviews and on-site inspections) should not be costly for the states to complete. States evidently have these types of records because they were able to provide us with this type of data for 1995 when we asked for it.

**NCSHA Has Recommended States Do More On-Site Inspections**

Although IRS has established minimum monitoring requirements, NCSHA has recommended that state agencies do more than required. For the most part, state agencies met or exceeded IRS’ monitoring requirements. However, in 1995 some of the agencies that did on-site inspections fell short of meeting the minimum on-site monitoring reviews recommended by NCSHA in 1993. NCSHA believed that IRS’ compliance monitoring rules were inadequate for preventing the abuse and physical deterioration that plagued many subsidized housing projects in the past.<sup>1</sup> Consequently, in its Standards for Tax Credit Administration, NCSHA recommended that on-site inspections be made to each project (1) within 1 year of its being placed in service and (2) at least once every 3 years thereafter.

On the basis of data state agencies provided us, we found that 22, or about 41 percent, of the 54 state agencies had adopted both NCSHA site visit recommendations. Table 5.2 shows the number of agencies that fully met, partially met, or did not meet NCSHA monitoring guidelines.

**Table 5.2: Number of State Agencies That Either Fully Met, Partially Met, or Did Not Meet NCSHA’s Monitoring Guidelines in 1995**

<b>NCSHA guideline</b>	<b>Number of state agencies</b>
On-site visit made within 1 year of placed in service date	8
On-site visit made at least once every 3 years	11
On-site visit made both within 1 year of placed in service date and once every 3 years	22 <sup>a</sup>
Did not make on-site visits either within 1 year of placed in service date or every 3 years.	13
<b>Total number of state agencies</b>	<b>54</b>

<sup>a</sup>Thirteen of the 22 agencies also performed on-site visits prior to the placed in service date.

Source: GAO analysis of state agency questionnaires.

<sup>1</sup>“Standards For State Tax Credit Administration,” adopted by the National Council of State Housing Agencies (1993).



On the basis of our analysis of state-provided data on sampled properties, we estimate that as of June 1996, 75 percent had received an on-site monitoring visit. We estimate that the average time between when a project was placed in service and when the first site visit was made was 21 months, which was 9 months more than the 12 months recommended by NCSHA.

Making site visits can allow state agencies to directly assess the compliance status of projects and the physical condition of buildings. Table 5.3 shows by type of monitoring review the types and frequency of noncompliance found by the states' desk reviews and on-site inspections.

**Table 5.3: Estimates on the Types of Noncompliance Identified by Desk Reviews and On-Site Inspections That Found at Least One Incident of Noncompliance**

<b>Type of noncompliance</b>	<b>Percent of time type of noncompliance found through desk review<sup>a</sup></b>	<b>Percent of time type of noncompliance found through on-site inspection<sup>a</sup></b>
Tenant(s) not income eligible	30	13
Rents too high	12	7
Building code violation or other building condition	0	43
Administrative requirement not met <sup>b</sup>	35	10
Annual income certification either submitted late or not received	53	34
Improper income certification or failure to properly verify certification	2	26
Other	16	7

<sup>a</sup>Noncompliance was identified through desk audits for 37 projects and through on-site inspections for 94 projects. In some cases, more than one type of noncompliance was found during a review.

<sup>b</sup>This category includes forms not filed on time, forms filed with incomplete information, or failure to meet other administrative requirements.

Source: GAO's analysis of sampled project questionnaires.

As shown in table 5.3, we estimate that in 43 percent of the instances when on-site inspections found noncompliance, the inspection identified a compliance problem involving the condition of the building. But, we estimate that no such violations were found during desk reviews. Building violations would generally not be detectable through a desk review of the owners' records unless the records showed the violations or the state also obtained such information as building code inspection reports that were

performed by the local government unit responsible for making these inspections.

Since states have the responsibility for ensuring that projects are habitable, it is unlikely that they can fully meet this responsibility unless they make site visits or obtain local building inspection reports. This points out a potential weakness in IRS' monitoring requirements, since two of the three monitoring options do not require states to make on-site visits or obtain local building inspection reports. Although NCSHA's monitoring guidelines recommend on-site visits, the states have no legal requirement to follow these guidelines. States currently doing site visits could cease making them and still be in compliance with IRS requirements.

According to IRS officials, IRS did not mandate on-site inspections, because some allocating agencies indicated that such a requirement would be burdensome. We would make two points in this regard. First, states had made on-site visits to 75 percent of our sampled properties. Thus, many states obviously consider this to be a best practice that is worth the cost. Second, there are less costly or less burdensome ways to obtain information on the physical condition of the housing projects. For example, states could contact local government units to obtain information on building inspections that may have been done on the properties. However, IRS regulations do not cite this as a requirement or as an option.

---

## **Most State Agencies Reported Noncompliance Issues to IRS**

As part of their monitoring responsibilities, state agencies are required to report to IRS and project owners all instances of owner noncompliance or the failure of owners to certify that projects meet statutory requirements.<sup>2</sup> For each building affected by the noncompliance, the states are to file Form 8823, Low-Income Housing Credit Agencies Report of Noncompliance, to meet this reporting requirement. Agencies are to explain on the form the nature of the noncompliance or failure to certify and indicate whether the owner has corrected the problem.

According to compliance data states provided us, noncompliance reporting to IRS by the state agencies varied in amount and significance.

---

<sup>2</sup>State agencies also have to notify owners, in writing, about the noncompliance and failure to certify. Owners may be given up to 90 days to correct any noncompliance or certification. The state agencies then have 45 days after the correction period to notify IRS of the infraction regardless of whether the infraction has been corrected. The correction period may be extended for up to 6 months if the agency determines that there is good cause for granting an extension.

**Chapter 5  
Opportunities Exist to Improve State and  
Federal Compliance Oversight Activities**

Table 5.4 shows the number of Form 8823s state agencies reported to us that they submitted to IRS as a result of their 1995 monitoring activities.

**Table 5.4: Number of Form 8823s Submitted by State Agencies to IRS in 1995**

Number of Form 8823s submitted to IRS	Number of state agencies	Total number of Form 8823s submitted
None	6	0
1 to 10	6	33
11 to 25	7	127
26 to 50	12	422
51 to 100	7	479
101 to 1,000	14	4,172
over 1,000	2	4,401
<b>Total</b>	<b>54</b>	<b>9,634</b>

Source: GAO's analysis of state agencies reported monitoring results from state agency questionnaire.

As shown in table 5.4, six agencies said they did not report any noncompliance to IRS, and two others reported over 1,000 Form 8823s. Since IRS' guidance to the agencies has been to report all noncompliance, no matter how insignificant it may seem, noncompliance reported can range from a serious infraction, such as failure to properly screen tenants for program eligibility, to an infraction such as a loose electrical outlet cover. According to state agency officials, about 31 percent, or 3,029, of the 9,634 Form 8823s submitted in 1995 had infractions that warranted IRS enforcement action.

Although most state agencies filed Form 8823s, several questioned the need to report noncompliance issues that have been corrected. According to IRS officials, all noncompliance, whether corrected or not corrected, needs to be reported because the tax consequences may be dependent on the timing of the correction of the noncompliance.

Some states also reported that they needed clarification on various issues dealing with project compliance. For example, additional clarification was requested by

- 32 states on the types of noncompliance that should be reported on Form 8823,
- 26 states on circumstances prompting recapture of tax benefits, and

- 28 states on IRS' authority to enforce project-specific requirements established by the states.

At the time of our review, IRS was in the process of revising Form 8823. The proposed revisions may resolve some of the states' concerns about the types of noncompliance that should be reported. For example, the current Form 8823 requires the allocating agency to indicate the date of noncompliance, provide a description of the noncompliance, and indicate whether the violation has been corrected. On the other hand, the proposed form includes a "check block" system for allocating agencies to check which of 10 categories describe the noncompliance being reported. These categories include violations for building disposition; income requirements; health, safety, and building codes; and changes to the eligible basis or number of low-income units or rent-restricted units. The proposed form also asks for summary information, including the total number of residential rental units in the building, the total number of low-income units, the total number of units reviewed by the state during the compliance check, and the total units determined to be out of compliance.

Although we believe the proposed form is an improvement over the current form because it lists the 10 types of noncompliance that should be reported, two other changes to the proposed form might allow IRS to better determine the severity of specific noncompliance categories. For example, for each category checked, it would be useful to know the number of units out of compliance and the date the noncompliance was corrected so that IRS could better determine whether the noncompliance has a tax consequence for the project owners.

---

### **Additional Compliance Activities Carried Out for Projects That Also Receive State Funds**

Many states perform more compliance activities for low-income housing tax credit projects that receive state funding than they do for projects that do not receive any additional state funding. Forty of the 54 tax credit allocating agencies provided state funds as another source for project financing, and 23 of these agencies did more monitoring of state-funded projects than of projects with no state funding. Some activities carried out for state-funded projects were:

- monitoring revenue and operating statements,
- reviewing funding of reserve accounts, and
- conducting more physical inspections of units.

These activities are to allow the state to assess the financial health of the project or the physical condition of the buildings, and therefore the long-term viability of the project as housing for low-income tenants. Thirteen allocating agencies that provide state funds reviewed monthly revenue and operating statements, and 25 agencies required annual revenue and operating statements. By comparison, only seven agencies reviewed either of these statements for projects not receiving any state financing.

Similarly, 24 agencies reviewed funding of replacement and operating account reserves for projects receiving state funds, and 5 reviewed such reserves for projects funded only with federal tax credits. We do not know whether projects in states with no reserve requirements are funding such reserves or not. However, if reserves are not available when the housing starts to age, the financial viability of the project could be in jeopardy because funds may not be available to make needed repairs.

In addition to requiring financial reports and reserve funding, states were more likely to physically inspect sample units in projects if there was state funding involved. Ninety-five percent made unit inspections when the project had received state funds, and 80 percent made unit inspections when no state funds had been provided to the project. Again, the physical condition of the housing has an impact on the viability of the project and the likelihood that it will continue to provide either low-income or market rate units after the 15 year tax credit compliance period.

---

### **Allocating Agencies Efforts to Inform Owners of Compliance Rules**

Most allocating agencies reported making efforts to help project owners and managers effectively administer the tax credit program through providing information or training. Since the program is administered at the most basic level by the project owners and managers who set rents and accept tenants into qualified units these efforts would seem useful. Although not required by IRS to do so, 45 allocating agencies reported that they either provide project owners and managers with optional training on compliance or require such training. Forty-eight allocating agencies also provided compliance manuals that set out tax credit rules with which a project must comply. All allocating agencies reported providing either manuals or training, or both, to project owners and managers.

---

## Opportunities to Improve IRS' Oversight Activities

IRS is responsible for ensuring that taxpayers claim only those tax credits for which they are entitled and for ensuring that states do not exceed their annual tax credit ceilings. A 1995 IRS report on its internal controls, which was done under the Federal Managers' Financial Integrity Act (FMFIA), identified the low-income housing tax credit program operations as a material weakness. The report noted that IRS was vulnerable to a loss of tax revenues due to taxpayer noncompliance, fraud, and abuse because it did not have systems in place to detect the noncompliance.

Given the FMFIA report and other internal findings, IRS adopted a low-income housing tax credit compliance strategy consisting of outreach activities aimed at keeping state allocating agency officials informed about program requirements and traditional enforcement tools (audits and document matching) aimed at detecting potential noncompliant states and taxpayers.

To verify that taxpayers do not claim more credits than they are entitled to claim, IRS has established a program to audit the returns of the key project owners, which are generally partnerships. IRS was using state noncompliance reports to develop potential audit leads, but as of September 30, 1996, few audits had been completed. IRS was also developing a computerized program that would match state tax credits awarded to projects to owners' tax returns to determine whether owners properly reported credit awards. We simulated this match on a sample of projects and found little noncompliance. To determine the level of compliance with the tax credit rules, IRS needs to develop an estimate of taxpayer compliance. To verify that state allocating agencies do not exceed their tax credit ceilings, IRS was developing a document matching program using state credit allocation reports to make this check.

---

## IRS' Outreach Efforts to Keep States Informed About Credit Requirements

As a means of helping state tax credit allocating agencies to comply with low-income housing tax credit requirements, IRS established a federal/state advisory group in November 1995 consisting of representatives from IRS, HUD, the National Park Service, and NCSHA. This group has met periodically to discuss outreach efforts, information exchange, and legislative activity. In addition, staff from IRS' low-income housing compliance unit, chief counsel, and national office have attended seminars sponsored by NCSHA. Representatives from the state allocating agencies also attended these seminars. According to IRS officials, during these seminars, state agencies were provided information on such subjects as the tax credit law, filing requirements, and property qualifications. Further, according to

---

representatives of IRS' chief counsel office, they receive daily telephone calls from state allocating agency officials concerning technical aspects of the low-income housing tax credit law.

---

**IRS Has Recently  
Developed a Tax Credit  
Audit Program, but Few  
Audits Have Been  
Completed**

IRS is responsible for ensuring taxpayer compliance with the Internal Revenue Code's low-income housing tax credit provisions. Just because a housing project received a tax credit allocation from the state does not automatically mean that the owners may take this credit amount annually for 10 years. For example, a housing project may qualify only for a portion of the allocation based on the number of housing units or floor area of units occupied by qualified tenants at the end of the tax year, so the annual tax credit amount may vary. Also, as discussed in chapter 4, states have awarded tax credits without obtaining audited construction and development cost certifications from independent third parties. Therefore, IRS may not be able to rely on cost certifications submitted by project developers to the state agency when it conducts its tax credit audits. IRS would need to audit these costs to ensure that nonqualifying items are not included in a project's qualified basis, which is supposed to include costs incurred by the developer only for valid rehabilitation, new construction, and acquisition costs. Conducting these audits requires specialized knowledge of the tax credit law.

In 1995, IRS established a national examination program under the leadership of IRS' Market Segment Specialization Program<sup>3</sup> with a core examination group in Philadelphia. The purpose of this program was to have a national coordinated approach for addressing tax credit compliance and to train agents on the intricacies of the tax credit laws. Each district office was requested to designate a coordinator to examine and monitor tax credit audits in its district. To facilitate this audit initiative, a training program was developed. By April 1996, revenue agents in 31 of the 33 IRS district offices had been trained and were assigned 180 potential audit cases. The potential audit cases were developed from reports of noncompliance made by the states. The Philadelphia group was to oversee the audit effort and accumulate data on which to assess compliance.

As of the end of fiscal year 1996, IRS had completed work on 35 audit cases (31 of the 180 assigned cases and 4 additional cases developed by District Offices). IRS found 12 to be in noncompliance with the tax laws and

---

<sup>3</sup>The Market Segment Specialization Program seeks to improve voluntary compliance by identifying compliance problems within market segments (taxpayers with common characteristics and tax situations) and prescribe appropriate treatments.

assessed taxes and penalties of about \$500,000 for reasons ranging from noncompliance with housing requirements to incorrect determination of eligible basis. A set of earlier audits related to a fraudulent tax credit scheme (a scheme that helped to prompt the tax credit audit initiative) and had resulted in tax adjustments totaling about \$5 million.

---

### **IRS Is Attempting to Develop a Housing Tax Credit Document Matching Program**

To supplement its tax credit audit initiative, IRS is exploring ways to make better use of state-reported information on tax credit awards. IRS' tax credit database currently contains Form 8609 data on the tax credits awarded to tax credit projects. IRS is exploring the possibility of computer-matching tax credit awards reported on Form 8609s against tax credit amounts reported on housing project tax returns, i.e., the overall amount of tax credits that the project is distributing to its investors.<sup>4</sup> The first step toward resolving any significant discrepancies uncovered through the match would be through correspondence with the owners.

To test the results that could be obtained from such a matching program, we requested tax year 1995 tax returns from IRS for our 423 sample projects to see if we could manually match state tax credit awards to the returns. As of January 31, 1997, we received and reviewed 253 project returns that had been awarded \$83.3 million in tax credits and found that 3 projects, awarded annual tax credits totaling \$930,000, overreported the credits by almost \$50,000.

Although our match did not uncover significant overreporting of the credit, we did find what could be a significant nonfiling problem. Our match of state data to IRS records found that 37 projects, awarded \$28.3 million in tax credits, did not file their 1995 tax returns.<sup>5</sup> Five of the projects had filed tax year 1994 returns and would have been detected by IRS as 1995 nonfilers in IRS' stop filer program, which identifies businesses that file one year but not the next. However, since IRS' records showed that the other 32 projects had not filed 1994 returns, these projects would not have been detected in the stop filer program. Matching state allocation

---

<sup>4</sup>IRS currently has a computer matching program to identify individual taxpayers who potentially underreported their taxable income, overreported certain deductions, or failed to file tax returns. Third parties, such as banks and other businesses, are required to file information returns to report various payments made to or by individuals. IRS matches amounts on information returns against amounts reported on individual tax returns to identify unreported income, overstated deductions, and nonfilers.

<sup>5</sup>In addition to the 37 nonfilers, 12 projects, awarded \$5.1 million tax credits, had not filed their returns but had received a filing extension from IRS; and 121 projects, awarded tax credits of \$51.3 million, had filed returns, but IRS did not retrieve them in time for our review.



documents to IRS' records might be the only way IRS could readily detect such nonfilers.<sup>6</sup>

Although matching state allocation documents to housing project partnership tax returns can uncover overreported credits or nonfiling, this match would not detect noncompliance at the partner level. But overreporting of tax credits by partners could be detected by matching tax credits reported on the Schedule K-1s to the partners' tax returns. In a June 1995 report on partnership compliance, we recommended that IRS match Schedule K-1 to tax returns.<sup>7</sup> However, resource constraints have prevented IRS from transcribing all the Schedule K-1s reporting tax credits it receives so that it could have an effective matching program.

---

### **An Estimate of Housing Tax Credit Compliance Would Help IRS Determine Its Enforcement Strategy**

IRS does not have an estimate of how many taxpayers may not be entitled to all of the credits they claim. IRS is depending on the results of its tax credit audit program to develop such an estimate. According to IRS officials, not enough audit cases have been worked to determine the extent of noncompliance. However, even after IRS completes a significant number of audits under its current approach, the results will not necessarily be a reliable measure of noncompliance. For the most part, IRS' audit efforts have been directed at targeting housing projects where states have filed reports of noncompliance to IRS as a result of the states' monitoring efforts. Thus, potentially noncompliant taxpayers whose projects the states did not find noncompliant would not be routinely picked up in IRS' current tax credit audit program. According to data we received from the state agencies, no compliance problems were found at about 75 percent of the projects inspected in 1995.

Without more information on tax credit compliance issues, IRS is not in a position to know how many or what type of compliance resources (audits or document matching) it needs to effectively address the issues. One way to develop a valid estimate of the degree of taxpayer noncompliance would be to audit a statistical sample of first-tier partnership returns on which the credit was claimed. The results of these audits could provide IRS with a measure of the compliance level as well as the types of tax credit

---

<sup>6</sup>Since these nonfilers were partnerships, failure to file partnership returns (Form 1065, U.S. Partnership Return of Income, Credits and Deductions, etc.) would not necessarily mean that the partners had not claimed the tax credits on their individual or corporate tax returns. The partnerships could have issued the partners' Schedule K-1, Partner's Share of Income, Credits and Deductions, etc., which shows each partner's separate share of the total partnership business activity, including the tax credit.

<sup>7</sup>Tax Administration: IRS' Partnership Compliance Activities Could be Improved (GAO/GGD 95-151, June 16, 1995).

noncompliance, such as nonqualifying items in projects' qualified basis. These types of data might also enable IRS to better target its low-income housing tax credit audit resources.

In determining whether to do such a study, IRS would need to weigh the costs and benefits of doing the study versus relying primarily on the results of its audit program to obtain data on the degree and types of tax credit noncompliance. For example, on the benefit side, IRS should consider the potential for recapturing tax credits since the tax credit program involves billions of tax dollars and complex tax law issues.

---

**IRS Is Developing a Document Matching Program to Determine Whether States Exceed Their Tax Credit Ceilings**

The Internal Revenue Code gives IRS responsibility for ensuring that states do not exceed their tax credit allocation ceilings. A state's credit ceiling is composed of (1) annual per capita credit allotment, (2) unused per capita credits from the previous year's allotment that the state did not allocate, (3) credit amounts that were initially allocated in previous years and were returned in the current year, and (4) credits given the state from the national pool of credits not used by other states. State agencies are to report this information annually to IRS on Form 8610, Annual Low-Income Housing Credit Agencies Report. This form also shows the dollar amount of the state's tax credit ceiling that was allocated during the calendar year.

The Code also requires states to annually report to IRS the amounts finally awarded to individual projects on a building-by-building basis. States are to report this information to IRS on Form 8609, Low-Income Housing Credit Allocation Certification, which is not issued until the project is placed in service. The form shows both the placed in service date and the allocation date. The year that a project is placed in service can be different from the allocation year because, in certain cases, developers have until the end of the second year after the credit is allocated to put the project in service. For example, a developer that received a 1992 allocation has until the end of 1994 to place the project in service.

To determine whether tax credit awards were within statutory ceilings, at the time of our review, IRS was developing plans to track both credit allocations and placed in service awards on a building-by-building basis. Since the Form 8609 shows the allocation date, it would appear that IRS could determine whether states exceeded their credit ceiling by totaling all the Form 8609s with the same allocation year and comparing this total to the total allocations shown on the Form 8610s for that year.

As part of the analysis that would need to be done to make this reconciliation, IRS would need to adjust each year's credit ceiling by the amount of tax credits that were returned by developers in subsequent years. These returned credits may be substantial. For example, in 1994 the states returned about \$80 million tax credits for reallocation, according to their Form 8610 filings. However, although the Form 8610 shows the total amount of credits that were returned from prior years' allocations, it does not identify them by allocation year. Therefore, unless IRS collects data on the allocation year of returned credits, it would not have an amount to compare Form 8609 totals against. Thus, IRS would not have a clear basis for determining whether states stay within their tax credit ceilings.

Collecting this additional data on returned credits would also allow IRS to determine whether the states are fully using their tax credit allocations. As discussed in chapter 3, a significant gap exists between the amount of tax credits that have been allocated by states and the amount of credits that states and IRS records show were awarded to projects that were placed in service.

---

## **Little Independent Oversight of State Housing Agencies' Operations**

Most federal programs operated by state and local governments are subject to independent oversight of state expenditures of federal funds. The Single Audit Act,<sup>8</sup> which is an important accountability tool for the hundreds of billions of dollars of federal financial assistance administered by state and local governments and nonprofit organizations, does not apply to tax credits because credits are not considered federal financial assistance under the Single Audit Act or OMB implementing guidance. Two state agencies have recently been audited by third parties, and weaknesses were found in the states' controls over the tax credit allocation process. Although section 42 of the Internal Revenue Code is silent on IRS' authority to oversee state agencies' operations, other sections of the Code implicitly give IRS the authority to audit state agencies' records. However, subjecting the low-income housing tax credit program to the single audit process may be a more efficient, effective, and less federally intrusive way of monitoring state agency controls over the program.

---

## **Third-Party Reviews of Two State Agencies Found Control Weaknesses**

According to information provided us by the allocating agencies, third-party reviews of state agencies' low-income housing credit operations have uncovered control weaknesses. Twenty agencies reported that their operations were audited by either the state or an independent

---

<sup>8</sup>The Single Audit Act was amended by the Single Audit Act Amendments of 1996.

third-party audit organization. Financial audits were performed on 17 agencies, and performance audits (e.g. assessing compliance with tax laws and regulations) were conducted on the remaining 3 agencies. One of the performance audit reports was published in 1991, and therefore it addressed problems that the state might have had early in program implementation. However, the other two performance audit reports, based on work performed in Texas and in New York State, were published in 1996 and described several internal control problems that raised questions about the possible need for ongoing oversight of state allocating agencies' operations. These two states ranked third and second, respectively, among state agencies in terms of tax credit allocations awarded to them by IRS in 1994 and accounted for about 14 percent of the total tax credits available nationwide in 1994.

The Texas audit was conducted by the Texas Office of the State Auditor. The following are several problems cited in the audit report.

- As discussed in chapter 3, agency management overrode staff recommendations on credit allocations in 29 of 46 projects that were evaluated for tax credits during one tax credit allocation cycle in 1995. The staff's recommendations were appropriately documented and based on applicable threshold and selection criteria.
- In contrast to staff recommendations, agency management decisions were not well documented and failed to include Underwriting Department recommendations to the agency's Board of Directors, which was customary for projects funded by other state and federal housing programs.
- Board members were in frequent contact with tax credit program staff. Since several of these Board members were actively involved in housing and real estate activities, this raised concerns of at least an appearance of a conflict of interest.
- Several projects that initially were rejected by the Underwriting Department were given conditional approval at the request of the Program Manager. However, there was no documentation that the agency's Board of Directors was informed of these conditions nor that these projects were returned to the Underwriting Department to ensure that the conditions had been met.

On June 14, 1996, the New York Office of the State Comptroller released a performance audit report of the New York State tax credit program

administered by the Division of Housing and Community Renewal (DHCR).<sup>9</sup> It also included a written response by DHCR to each of the major audit findings. In general, the audit found that DHCR had not established adequate procedures to ensure that all tax credit allocations are reasonable and appropriate. Set forth below are summaries of two specific audit findings concerning federal tax credit requirements and DHCR's response to each finding.

1. Project costs were not evaluated for reasonableness through the use of established formal criteria or in a manner similar to other state housing programs, which used cost guidelines limiting the cost per housing unit for specific project types by geographic region. Overall, the state audit found that total development costs for tax credit projects with 8,768 units placed in service between January 1990 and February 1995 ranged between 11 percent to 43 percent higher than other DHCR-funded projects that did not receive tax credit funding. Had the average cost per unit for the tax credit units been kept within state guidelines, total development costs would have been reduced by about \$146 million. This reduction in development costs would have resulted in tax credit allocations being reduced by \$105 million over the 10-year life of the tax credits.

DHCR's response to the audit findings was that cost guidelines were used for many tax credit projects, particularly those that were also funded by government agencies. DHCR maintained that if another government entity, such as the City of New York, was responsible for a project then that agency should be responsible for limiting development costs. DHCR believed that the state auditor's recommendation to apply state housing cost limitations to other governmental jurisdictions is not a reasonable approach.

2. The auditor reported that projects had purposely been granted credits in excess of amounts needed without the underwriting staff performing the necessary funding gap analysis. A pool of 20 housing projects that were originally going to be funded by state housing trust funds was allocated over \$100 million in tax credits over 10 years without DHCR "ensuring that the credit allocations were limited to the amount needed." The audit also found that the cost certifications for each of these 20 projects were based on estimated, rather than actual, development costs because the

---

<sup>9</sup>We reviewed the state audit report and most of the audit work papers. We also discussed these findings with state auditors, senior DHCR officials, and the syndicator for the 20 project syndication pool. Although we requested DHCR officials to provide us with additional documentation and clarification to support DHCR's position, none was provided.

developers were not required to provide actual cost data to the cost certifiers.

DHCR's response was that it performed the necessary funding gap analysis for each project. The net equity raised by the tax credits was used to reduce the permanent loan amounts and to reduce the interest rate on state bonds issued by the state housing agency.

---

### **IRS Has Not Conducted Reviews of State Allocating Agencies' Operations**

According to an IRS Chief Counsel official, section 42 of the Internal Revenue Code does not explicitly address what responsibilities or authority IRS has for ensuring that allocating agencies fulfill their tax credit responsibilities under that statute. However, the official noted that under the Code, IRS has the authority to make broad inquiries regarding the correctness of returns filed with IRS, including the authority to summons and examine the books and records supporting the returns. According to the IRS Chief Counsel official, since the Code requires allocating agencies to report tax credit allocation information to IRS, IRS can examine the agencies' records that support these information returns.

The Chief Counsel official stated that if, in the course of an examination of a state's information return, IRS determines that a state was not in compliance with its qualified allocation plan it could ultimately disallow a state's entire credit allocation amount for the period of noncompliance. Use of this authority, however, is of concern to IRS compliance officials because the impact would be on taxpayers who received credits from a noncompliant agency, but who may not be responsible for the noncompliant activity. The Code does not give IRS authority to levy sanctions against state agencies that would not affect taxpayers who have already received credits.

According to IRS compliance officials, any oversight reviews of allocating agencies' operations activities would be based on reviews of allocating agencies' compliance with tax credit allocation and monitoring reporting requirements and on tax credit audit findings for indications of shortcomings in state implementation of responsibilities. However, IRS currently does not have plans to undertake such examinations and said it would be reluctant to do so without congressional direction.

---

## Single Audits May Be One Way to Provide Oversight of Allocating Agencies' Operations

The single audit process is designed to provide systematic audit coverage of state and local governments and nonprofit organizations that administer federal programs. Generally, subject entities that expend \$300,000 or more in federal financial assistance are required to arrange for an audit of their financial statements and additional testing of federal programs. Auditors are generally required to use a risk-based approach in selecting federal programs for audit. However, neither the Single Audit Act nor implementing guidance issued by OMB includes tax credits in the definition of federal financial assistance.

We found that most state tax credit allocating agencies also receive federal financial assistance, such as CDBG and HOME funds. These agencies are covered by the Single Audit Act if the amount of federal financial assistance expenditures equals or exceeds \$300,000 annually. Auditors would test controls over federal programs and test for compliance with federal laws and regulations for programs selected for audit. However, OMB implementing guidance for the Single Audit Act does not include the low-income housing tax credit in the definition of federal financial assistance. Therefore, the tax credit program would not be subject to the Single Audit Act.

However, since the tax credit program has compliance requirements that could be tested as part of a single audit, the program may be a good candidate for coverage under the single audit process. Since most state agencies are already undergoing single audits for other types of federal assistance they receive, the low-income housing tax credit could be included with the other programs for the auditor to determine whether it is one of the programs that should be tested under the risk-based approach.

The Code allows state agencies to charge fees to developers for the costs states incur for processing and evaluating project proposals and for monitoring projects after they are awarded tax credits. The costs of single audits are shared between the auditee and the federal government based upon the relationship between the entity's expenditure of federal financial assistance and the entity's total expenditures. Any additional costs the state entity may incur could be incorporated in states' administration and monitoring fees.

---

## Conclusions

State allocating agencies report that they have adopted project monitoring programs that meet IRS regulations, but some states reported inspecting

fewer projects than required in 1995. However, IRS had no reporting system to determine whether states met their agreed-on monitoring levels. For IRS to determine whether states follow their monitoring procedures, it would need a report from state allocating agencies on the number and types of monitoring inspections they made. IRS could then compare these numbers with the number of inspections that should be made under states' monitoring procedures in their qualified allocation plans.

IRS' monitoring regulations do not require states to make on-site project inspections or other reviews, such as reviews of local government reports on building code violations, that would allow states to detect violations of the Internal Revenue Code's habitability requirements. For IRS to better ensure that habitability problems are identified during state monitoring reviews, states would have to do on-site inspections or obtain information from other sources, such as local government reports on building inspections results.

IRS is revising the form states use to report projects that are not in compliance with Internal Revenue Code requirements. These revisions should help clear up some of the problems states had in determining what types of noncompliance they should report. However, IRS will still not be able to easily determine whether the noncompliance reported by states warrants recapturing credits from project owners because the revised form we reviewed did not include information on the number of units that were not in compliance and the date the noncompliance was resolved.

IRS is relying on the results of its audit initiative to provide estimates on the extent and types of noncompliance that exist in the tax credit program. It is important for IRS to have this information so that it can determine how many resources to apply to tax credit compliance problems. However, IRS' current audit program is not based on a random sample of returns and will not provide statistically reliable compliance data. If cost-effective, a better estimate of noncompliance could be obtained from audits of a statistically valid random sample of partnership returns claiming the tax credit. There may also be other cost-effective ways to obtain reliable compliance data. Also, IRS is not in the best position to determine whether states exceed their tax credit ceilings because it lacks key information on the amount of tax credits that were initially allocated to projects and later returned for reallocation.

There is no third-party oversight of state allocating agencies' low-income housing tax credit program operations. Unlike other state programs that



are federally funded, the tax credit program is not subject to single audits because neither the Single Audit Act nor implementing guidance issued by OMB includes tax credits in the definition of federal financial assistance. Including low-income housing tax credits in the definition of federal financial assistance so that the tax credit program could be subject to the Single Audit Act would be one way of promoting state compliance with tax credit laws and regulations.

---

## **Recommendations to the Commissioner of Internal Revenue and Director, Office of Management and Budget**

The low-income housing tax credit program has stimulated low-income housing development in the United States and states' implementation of the allocation process generally meets the requirements of the Internal Revenue Code. However, some states' and IRS' procedures for oversight of general compliance with laws and regulations could be improved. Accordingly, we recommend that the Commissioner of Internal Revenue amend regulations for the tax credit program to (1) require that states report sufficient information about monitoring inspections or reviews, including the number and types of inspections made, so that IRS can determine whether states have complied with their monitoring plans; and (2) require that states' monitoring plans include specific steps, such as site visits, that will provide information to permit IRS to more effectively ensure that the Code's habitability requirements are met. We also recommend that the Commissioner explore alternative ways to obtain better information to verify that states' allocations do not exceed tax credit authorizations and to evaluate compliance with the requirements of the Code by taxpayers and housing projects.

Finally, to help ensure appropriate oversight of state allocating agencies' overall compliance with tax credit laws and regulations, we recommend that the Director, Office of Management and Budget, incorporate the low-income housing tax credit program in the definition of federal financial assistance included in implementing guidance for the Single Audit Act, as amended, so that the program would be subject to audits conducted under the Single Audit Act.

---

## **Federal Agency and State Association Comments and Our Evaluation**

IRS, NCSHA, and OMB commented on these recommendations. IRS agreed with the recommendations addressed to it and orally advised us that it had already started to implement a reconciliation procedure.

OMB advised GAO that it did not take exception to strengthening accountability over the low-income housing tax credit program by building

on an existing accountability mechanism such as the single audit concept. However, OMB said that incorporating the low-income housing tax credit in the definition of federal financial assistance included in implementing guidance for the Single Audit Act would likely require a broader evaluation of accountability for tax credit programs in general, and the application of the single audit concept in particular. Also, OMB indicated that any changes in tax credit accountability might be accomplished more appropriately through legislation than through administrative initiative.

We do not object to OMB's premise about an approach for considering how to make the low-income housing tax credit program subject to audits conducted under the Single Audit Act. We also note that an evaluation along the lines suggested by OMB could also include an assessment of whether and, if so, what legislation might be most appropriate.

NCSHA commented on a number of points with respect to the information in this chapter.

- First, NCSHA raised concerns about bias and prejudice in the report because it believed the report implied that a housing agency was deficient if it did not adopt a NCSHA best practice and that the report omitted some unspecified corrective actions taken in Texas and New York. In response, we note that the report repeatedly points out that the states were given flexibility in the administration of the program. The report states that allocating agencies have no legal requirement to follow Council best practices, such as making site visits. With respect to agency corrective actions, we reported on the actions that we found at the time of our visits to the states. For example, with respect to the issue of discretionary awards, we reported that New York's allocating agency, in August 1996, eliminated a clause in its allocation plan giving the head of the agency the discretion to award over 20 percent of the annual allocation, or \$4.5 million. We also reported on actions taken by California to introduce a new system of cost controls and the benefits California cited as a result of the change. NCSHA's mention of New York and Texas seem to refer to the results of the two internal audit reports discussed in this chapter. The New York state tax credit allocating agency disagreed with the state audit report's findings and recommendations. In Texas, the Executive Director of the State Housing Department, which includes the state tax credit allocating agency, concurred with the recommendations in the state audit report and stated that corrective actions would be taken. Actions to address the issues in the reports had not, to our knowledge, been taken at the time of our visits to the states.

- Second, NCSHA raised a concern about the cost effectiveness and burden of some of the recommendations. NCSHA said the recommendation involving a requirement for the states to report monitoring information to IRS should be limited to information that is both pertinent and useful. NCSHA also said that the Single Audit Act should not interfere with the appropriate exercise of state responsibilities. We agree with the general thrust of these issues and, in fact, considered them as we developed our recommendations. For example, in making our recommendation to use the Single Audit Act to strengthen federal oversight of the tax credit program, we point out the fact that the act was established to eliminate potentially duplicative and burdensome federal oversight reviews.
- Third, NCSHA commented that the report offers little evidence on the extent of tax credit overallocations or property owner noncompliance but recommends that IRS explore ways to obtain better information to verify that state allocations do not exceed their authorizations and evaluate taxpayer compliance. Our recommendations were developed with the intent to better position IRS to carry out its responsibilities for ensuring compliance.

# Statistical Methodology for Evaluating the Low-Income Housing Tax Credit Program

---

This appendix describes the sampling methodology and statistical precision of the samples we used in our review of the low-income housing tax credit program.

---

## Sampling Methodology

We gathered information on the low-income housing tax credit program through four structured data collection surveys. Three of these required samples of their respective populations. These three were (1) tax credit allocating agency survey, (2) low-income housing project survey, and (3) project manager survey. The fourth survey dealt with third-party cost certifications.

The first data collection survey gathered information about tax credit allocating agencies' policies, procedures, and controls. We gathered this information using a questionnaire from the entire population of 54 allocating agencies, which included 50 state agencies, the District of Columbia, two suballocating agencies in New York state, and a suballocating agency in Chicago. All of the 54 agencies responded to the questionnaire and thus provided the 100 percent response rate.

The second data collection survey collected information from tax credit allocating agencies on the characteristics of their sample tax credit projects. We collected this information using a questionnaire from a probability sample of 423 low-income housing projects to represent the total estimated population of 4,121 projects in the continental United States. We excluded Alaska and Hawaii projects from our sample because of cost considerations, since we would be unable to visit these agencies to verify project data. The remaining 52 allocating agencies initially provided us with a list with 4,225 projects. After removing four duplicates, a total of 4,221 projects remained in the list. After sampling and accounting for erroneously provided data (see app. III), our sample of 423 projects represent our total study universe of an estimated 4,121 projects with 172,151 low-income units that were authorized for tax credits and were placed in service in the 48 contiguous states and the District of Columbia from January 1, 1992, through December 31, 1994.

The representative probability sample of 423 projects was drawn from two strata, a large project stratum and a small project stratum. The large project stratum consists of 29 projects with more than 300 units in each project. All 29 of these projects were included in the sample. The remaining small project stratum of the study population consists of an estimated total of 4,092 projects containing 161,066 units. A sample of 394

projects represents this stratum. We drew these 394 projects into the sample with probabilities proportionate to their size, as measured by their numbers of low-income housing tax credit units. Our sample of 423 has been properly weighted to represent the estimated population of 4,121 projects for all results presented in the report. For example, although each of the projects from the large project stratum represents only itself in the analysis, the smallest project in the small project stratum represents over 150 projects. Data were received for everyone of the 423 sampled projects for a response rate of 100 percent.

The third data collection survey gathered data directly from the sample projects on tenant and unit characteristics particular to their properties to represent the same estimated population of 4,121 projects. The project managers for the 423 sampled projects were sent a questionnaire requesting information about their projects and all of the units contained in their projects. Questionnaires were returned for 380 of the projects, for a project response rate of 90 percent. We compensated for the three nonresponding projects in the large project sample stratum by increasing the weight for the 26 responding projects' answers to represent the population of 29 large projects. Similarly, we compensated for the 40 nonresponding projects in the small project stratum by weighting the 354 respondents' answers to represent the population of 4,192 small-size projects.

The fourth data collection survey gathered data on third-party cost certification procedures for a probability sample of 48 projects. These 48 projects were sampled from the 423 previously sampled projects. The projects were drawn with probabilities proportionate to the number of units. As a result, each sampled project represents approximately the same number of housing units in the total population of 172,151 housing units. The sample was again drawn from two strata—three selections from the large project stratum and 45 selections from the small project stratum. We obtained data for all 48 projects for a response rate of 100 percent.

---

## **Sampling Errors and Confidence Intervals of Estimates**

Since we used a sample (called a probability sample) of properties and tenants to develop our estimates from the project and project manager questionnaire information, each estimate has a measurable precision, or sampling error, which may be expressed as a plus/minus figure. A sampling error indicates how closely we can reproduce from a sample the results that we would obtain if we were to take a complete count of the universe using the same measurement methods. By adding the sampling

error to and subtracting it from the estimate, we can develop upper and lower bounds for each estimate. This range is called a confidence interval. Sampling errors and confidence intervals are stated at a certain confidence level—in this case, 95 percent. For example, a confidence interval at the 95 percent confidence level means that in 95 out of 100 instances, the sampling procedure we used would produce a confidence interval containing the universe value we are estimating.

This section provides the sampling errors of estimates, referred to in this report, that were made from these questionnaires. The sampling errors are provided in a series of tables.

Table I.1 provides sampling errors for estimates made from the information in the project questionnaire. Table I.1 first provides information on estimates about properties, followed by information on estimates about apartment units. Within each of these two main sections, estimated percentages are given first, followed by estimated means, totals, and ratios.

Table I.2 provides sampling errors for estimates that use information from the project manager questionnaire. All the estimates in this table relate to tenants occupying low-income units. Percentage estimates are provided first, followed by estimates of means, totals, and ratios.

Table I.3 provides sampling errors for table 2.1 containing economic data on low-income households with and without additional rental assistance.

Table I.4 provides sampling errors for income data on low-income households by type of housing assistance provided.

Table I.5 provides sampling errors for current incomes by type of qualifying household reported by property managers in 1996.

Table I.6 provides sampling errors for the ratio of household current income to applicable area median income by type of qualifying household.

Table I.7 provides sampling errors for table 5.3 on types of noncompliance reported from the project questionnaire.

Table I.8 provides sampling errors for figure 4.1 on sources of development financing for projects receiving grants/donations, concessionary loans, or Rural Housing Service (515) loans.

Estimates in these tables do not always represent the entire population because some questions on the questionnaires were not always answered. The size of the population represented by each estimate is also given in the sampling error tables when the entire population is not represented.

---

## **Controlling for Nonsampling Errors**

In addition to the reported sampling errors, the practical difficulties of conducting any survey may introduce other types of errors, commonly referred to as nonsampling errors. For example, differences in how questions are interpreted, errors in entering data, incomplete sampling lists, and the types of people who do not respond can all introduce unwanted variability into the survey results. We included steps in both the data collection and data analysis stages for the purpose of minimizing such nonsampling errors. Some of these steps included pretesting questionnaires with property managers, reviewing answers during follow-up visits to agencies, double-keying and verifying all data during data entry, and checking all computer analyses with a second analyst.

Based on the data available, the effect of nonresponses on the representativeness of our project manager sample appears to have been small. To obtain information about the possible effect of nonresponses, we compared five characteristics of the 90 percent of the projects that responded to our housing unit questionnaire with the 10 percent that did not. The greatest difference between the respondent and nonrespondent groups was in the extent of location in urban and rural areas. Lesser differences were found for the following four other items that were examined: the absence of project reevaluations if the numbers of housing units changed after the original tax credit reservation, the primary project goal (serving the elderly or not), ever having been inspected and identified as noncompliant, and being noncompliant because the annual income certification had been submitted late or not received. In order to assess the implications of these differences for our reported results, we estimated the values of the 5 characteristics based on our total sample of 423 and also for our 380 respondents. After weighting to the population, we compared the total sample with the respondents. For the 5 characteristics that we examined, the combined effect of the 90 percent response rate and the nonresponse weighting was that there was no more than a 2.3-percent difference between the weighted totals for the 380 respondents and the totals for the entire sample of 423 projects.

**Appendix I  
Statistical Methodology for Evaluating the  
Low-Income Housing Tax Credit Program**

**Table I.1: Sampling Errors of Estimates From Information in the Project Questionnaire**

Description	Estimate	Sampling error	Confidence interval	
			From	To
<b>Percentage of properties</b>				
What is the legal ownership of this property?				
General partnership	2	1	0	3
Limited partnership	82	12	70	94
Individual	12	12	0	24
S-Corp	1	1	0	2
C-Corp	0	0	0	1
Limited liability company	1	1	0	2
Other	2	2	(1)	4
Is the project sponsor either an organization or a for-profit subsidiary of a nonprofit organization?				
Yes	22	6	15	28
No	78	6	72	85
Not answered	0	0	0	1
What minimum set-aside requirement did this project select?				
20% of rental residential units at 50% of median area income (20/50)	4	2	2	6
40% of rental residential units at median area income (40/60)	88	9	79	97
Other (i.e., deep-rent skewing)	8	9	(1)	17
What types of buildings comprise this project? <sup>a</sup>				
Elevator/high-rise	10	3	7	13
Walk-up/garden	57	11	46	68
Townhouse/rowhouse	18	5	12	23
Single-family detached	4	3	1	7
Other	19	14	6	33
Which of the following populations is this project primarily intended to serve?				
Family	70	7	62	77
Elderly	26	7	19	32

(continued)



**Appendix I  
Statistical Methodology for Evaluating the  
Low-Income Housing Tax Credit Program**

Description	Estimate	Sampling error	Confidence interval	
			From	To
<b>Percentage of properties</b>				
Special needs (physically or mentally disabled)	1	2	0	3
Previously homeless	1	1	0	1
Other	3	2	1	4
In what type of geographic area is this project located?				
Urban	36	9	27	45
Suburban	10	3	7	14
Rural	53	10	44	63
Other	0	0	0	1
As indicated on the IRS Forms 8609, what type of construction is this project? <sup>a</sup>				
Newly constructed:				
With federal subsidies	35	10	26	45
Without federal subsidies	38	11	27	49
Existing building	12	4	7	16
Sec 42(e) rehabilitation expenditure:				
With federal subsidies	7	4	3	11
Without federal subsidies	20	6	14	25
Did the sources and uses of funds differ by 5% or more?				
Yes	14	9	5	23
No	86	9	77	95
Did the property receive a grant or donation or a soft loan from CDBG, HOME, AHP, state government, local government, or other nonrural (non-RHS 515) source?				
Yes	37	10	27	46
No	63	10	54	73
Distribution of net equity prices				
Less than \$0.40	9	11	(2)	20
\$0.40 to \$0.49	39	9	31	48
\$0.50 to \$0.59	32	10	23	42
\$0.60 to \$0.69	10	5	5	16

(continued)

**Appendix I  
Statistical Methodology for Evaluating the  
Low-Income Housing Tax Credit Program**

Description	Estimate	Sampling error	Confidence interval	
			From	To
<b>Percentage of properties</b>				
\$0.70 or more	8	4	4	13
N. proj.	3,605	642	2,963	4,247
For the property, were the amounts known for both the tax credits awarded and the tax credit equity raised?				
Yes	86	9	76	95
No	14	9	5	24
Were any on-site inspections performed?				
Yes	75	7	69	82
No	25	7	18	31
Projects with extended use commitments exceeding program requirements.				
Yes	69	11	58	80
No	31	11	20	42
Projects with Section 515 RHS loans (50-year commitment to low-income use).				
Yes	32	8	24	40
No	68	8	60	76
Projects with HOME financing (20-year commitment to low-income use).				
Yes	5	4	1	8
No	95	4	92	99
Did project development cost include the cost of land?				
Yes	91	4	87	95
No	9	4	5	13
Did property receive grants/donations or concessionary loans (soft mortgages or Rural Housing Service (515) loans), or did at least one tenant receive rental assistance?				
Yes	86	12	73	98
No	14	12	2	27

(continued)

**Appendix I  
Statistical Methodology for Evaluating the  
Low-Income Housing Tax Credit Program**

Description	Estimate	Sampling error	Confidence interval	
			From	To
N. proj.	4,082	746	3,335	4,828
<b>Means for properties</b>				
Total number of units in project, including any apartments reserved for management.				
Mean	43	8	35	50
N. proj.	4,212			
Total number of tax credit units.				
Mean	40	7	33	47
N. proj.	4,212			
Time in months between when the project was placed in service and the first on-site inspection of the project.				
Mean	21	2	19	23
N. proj.	3,179			
<b>Totals for properties</b>				
Tax credit awards in millions of dollars (annual amounts per line 1b, Form 8609).				
Total	607	49	558	656
N. proj.	4,212			
Development cost in millions of dollars.				
Total	10,669	1,697	8,972	12,366
N. proj.	4,212			
Total grants/donations, soft mortgages, and Rural Housing Service (515) loans in millions of dollars.				
Total	2,946	574	2,372	3,520
N. proj.	4,212			
<b>Ratios for properties</b>				
Tax credit award at placed in service date in relation to the Maximum Potential Tax Credit Award based on qualified basis.				
Percent	97	1	96	98

(continued)

**Appendix I  
Statistical Methodology for Evaluating the  
Low-Income Housing Tax Credit Program**

Description	Estimate	Sampling error	Confidence interval	
			From	To
<b>Ratios for properties</b>				
N. proj.	4,212			
Average equity price in cents.				
Mean	53	1	51	54
N. proj.	3,605			
Percent of total development cost:				
Construction expenses	55	4	50	59
Construction-related fees	25	1	24	26
Other (e.g., acquisition of property)	21	5	16	25
Total	100			
N. proj.	4,212			
Percent of total funds for properties where sources and uses of funds did not differ by 5 percent or more.				
Tax credit equity	29	5	24	33
Commercial lender and other hard mortgages (payment required) excluding Rural Housing Service (515) loans.	36	4	32	40
Rural Housing Service (515) loans, total soft mortgage, grant/donations, equity other than tax credit equity, and other sources.	36	4	32	40
Total	100			
N. proj.	3,616			
Percent of grants/donations, total soft mortgages, and Rural Housing Service (515) loans that are federally funded (i.e., CDBG, HOME, AHP, or Rural Housing Service (515) loans).				
Percent	50	10	40	61
N. proj.	2,919			
<b>Percentage of units</b>				
Percent of total units at placed in service (Note: total does not always equal sum of bedroom categories.)				
Efficiency	6	2	4	8
1 bedroom	36	3	32	39
2 bedroom	41	3	38	44
3 bedroom	16	2	14	18

(continued)

**Appendix I  
Statistical Methodology for Evaluating the  
Low-Income Housing Tax Credit Program**

Description	Estimate	Sampling error	Confidence interval	
			From	To
<b>Percentage of units</b>				
4 or more bedrooms	1	0	1	2
Other	0	0	0	1
N. units	175,100			
Percent of total units in:				
Urban locations	48	5	43	53
Suburban locations	23	4	19	27
Rural locations	28	4	24	33
Other locations	b	b	b	b
Total	100			
N. units	179,171			
Percent of total units with unit costs:				
Less than \$20,000	10	3	7	13
\$20,000 to \$39,999	21	4	17	25
\$40,000 to \$59,999	36	5	31	40
\$60,000 to \$79,999	14	4	11	18
\$80,000 to \$99,999	8	2	6	11
\$100,000 to \$119,999	4	2	2	6
\$120,000 to \$139,999	2	1	0	3
\$140,000 to \$160,000	2	2	0	4
Over \$160,000	3	2	0	5
Total	100			
N. units	179,171			
Percent of tax credit units with tax credit cost per unit (present valued at 6.7%) of:				
Less than \$10,000	20	4	17	24
\$10,000 to \$19,999	26	4	22	30
\$20,000 to \$29,999	19	4	15	22
\$30,000 to \$39,999	16	3	13	20
\$40,000 to \$49,999	7	2	5	10
\$50,000 to \$59,999	3	2	1	4
\$60,000 to \$69,999	3	2	1	5
\$70,000 or more	6	2	4	8

(continued)

**Appendix I  
Statistical Methodology for Evaluating the  
Low-Income Housing Tax Credit Program**

Description	Estimate	Sampling error	Confidence interval	
			From	To
<b>Percentage of units</b>				
Total	100			
N. units	168,934	2,094	166,841	171,028
Tax credit costs per tax credit unit (present valued at 6.7%) is less than or equal to \$27,310.				
Yes	60	5	56	65
No	40	5	35	44
Total	100			
N. units	168,934	2,094	166,841	171,028
Tax credit costs per tax credit unit (present valued at 6.7%) is greater than \$100,000.				
Yes	2	1	1	3
No	98	1	97	99
Total	100			
N. units	168,934	2,094	166,841	171,028
<b>Means and ratios for units</b>				
Total certified development cost per unit				
Urban	66,651	16,080	50,572	82,731
N. units	85,893			
Suburban	57,489	5,543	51,946	63,032
N. units	41,625			
Rural	49,478	3,637	45,840	53,115
N. units	50,835			
Other	b	b	b	b
Total	59,545	8,069	51,476	67,614
Total certified development cost per unit				
Land cost known?				
Yes	59,720	9,033	50,687	68,753
N. units	158,297			

(continued)

**Appendix I  
Statistical Methodology for Evaluating the  
Low-Income Housing Tax Credit Program**

Description	Estimate	Sampling error	Confidence interval	
			From	To
<b>Means and ratios for units</b>				
No	58,216	10,081	48,135	68,296
N. units	20,874			
Total	59,545	8,069	51,476	67,614
N. units	179,171			
Total certified development cost per unit in properties:				
With new construction	67,513	12,613	54,900	80,126
N. units	107,833			
Without new construction	47,501	5,190	42,311	52,691
N. units	71,338			
Total certified development cost per unit in properties:				
With rehabilitation	48,250	5,191	43,059	53,441
N. units	71,800			
Without rehabilitation	67,098	12,685	54,413	79,783
N. units	107,371			
Total certified development cost per unit in properties of following building type:				
Elevator/high-rise	97,874	35,251	62,622	133,125
N. units	34,230			
Walk-up/garden	49,303	2,974	46,329	52,277
N. units	117,349			
Townhouse/rowhouse	60,901	7,277	53,625	68,178
N. units	30,033			
Single-family detached	b	b	b	b
Other	b	b	b	b
Percent of units qualified for tax credits	95	3	92	97

(continued)

**Appendix I  
 Statistical Methodology for Evaluating the  
 Low-Income Housing Tax Credit Program**

Description	Estimate	Sampling error	Confidence interval	
			From	To
N. units	182,140			
Tax credit amount per unit (present valued at 6.7%)	27,310	2,138	25,172	29,448
N. units	168,934			

Note 1: Sampling errors and confidence intervals are calculated at the 95-percent level of confidence.

Note 2: Unless otherwise stated, these estimates apply to the estimated 4,212  $\pm$  746 properties.

Note 3: "N. proj." provides the number of projects to which the estimate applies.

Note 4: "N. units" provides the number of apartment units to which the estimate applies.

<sup>a</sup>The sum of the percentages should not equal 100 percent because respondents were asked to check more than one item, if appropriate.

<sup>b</sup>Too few occurrences (fewer than 30 properties) in sample to make estimate.

Source: GAO's analysis of project questionnaire.



**Appendix I  
Statistical Methodology for Evaluating the  
Low-Income Housing Tax Credit Program**

**Table I.2: Sampling Errors of Estimates About the Households Occupying LIHTC Units**

Description	Estimate	Sampling error	Confidence interval	
			From	To
<b>Percentage of households</b>				
Number of people living in household				
1 Person	43	3	39	46
2 Persons	24	1	23	26
3 Persons	17	1	16	18
4 Persons	11	1	10	12
5 or More persons	6	1	5	7
Total	100			
N=	157,430	6,157	151,273	163,588
Is anyone in household receiving a rental subsidy?				
Yes	39	4	35	43
No	61	4	57	65
Total	100			
N=	155,226	6,256	148,970	161,481
Gender of head of household				
Male	36	2	34	38
Female	64	2	62	66
Total	100			
N=	154,412	6,282	148,130	160,694
Race of head of household				
White	53	4	49	57
Black	33	4	29	37
Hispanic (not black)	11	2	9	13
Other	4	1	3	5
Total	100			
N=	132,247	7,616	124,631	139,863

(continued)

**Appendix I  
Statistical Methodology for Evaluating the  
Low-Income Housing Tax Credit Program**

Description	Estimate	Sampling error	Confidence interval	
			From	To
<b>Percentage of households</b>				
Current annual household income				
< \$5,000	10	2	8	11
\$5,000-\$9,999	29	3	26	31
\$10,000-\$14,999	23	2	22	25
\$15,000-\$19,999	20	2	19	22
\$20,000-\$24,999	11	1	10	12
\$25,000 or more	7	1	6	8
Total	100			
N=	156,116	6,132	149,983	162,248
Head of household's age				
<= 34	44	3	42	47
35 - 54	26	2	25	28
>= 55	29	4	25	33
Total	100			
N=	146,565	6,725	139,840	153,291
Household income as a percent of median income				
30% and under	39	3	36	41
31-50%	39	2	37	40
51-60%	16	2	15	18
61% and over	6	1	5	7
Total	100			
N=	159,331	6,079	153,252	165,411
Is the apartment unit overcrowded?				
Yes	2	1	2	3
No	98	1	97	98
Total	100			
N=	156,689	6,183	150,506	162,872
If the apartment unit is overcrowded, what is the apartment size?				
Efficiency	10	5	5	16
1 bedroom	51	8	43	58
2 bedrooms	31	7	24	37
3 bedrooms	8	4	4	12

(continued)

**Appendix I  
Statistical Methodology for Evaluating the  
Low-Income Housing Tax Credit Program**

Description	Estimate	Sampling error	Confidence interval	
			From	To
<b>Percentage of households</b>				
4 bedrooms	1	1	0	1
Total	100			
N=	3,621	1,005	2,615	4,626
For households receiving subsidies, is total current monthly rent charged, including utility allowance and rental subsidy, greater than the maximum tax credit allowable rent (including utilities), as of April 1, 1996?				
Yes	25	6	19	31
No	75	6	69	81
Total	100			
N=	60,714	6,686	54,028	67,400
For households receiving subsidies, is total current monthly rent charged, including utility allowance and rental subsidy, 121 percent or more of the maximum tax credit allowable rent (including utilities), as of April 1, 1996?				
Yes	7	3	3	10
No	93	3	90	97
Total	100			
N=	60,714	6,686	54,028	67,400
Is the household receiving subsidies, and is the total current monthly rent charged, including utility allowance and rental subsidy, greater than the maximum tax credit allowable rent (including utilities), as of April 1, 1996?				
Yes	10	3	7	13
No	90	3	87	93
Total	100			
N=	154,401	6,344	148,057	160,744
Is the household receiving subsidies, and is the total current monthly rent charged, including utility allowance and rental subsidy, 121 percent or more of the maximum tax credit allowable rent (including utilities), as of April 1, 1996?				
Yes	3	1	1	4
No	97	1	96	99
Total	100			
N=	154,422	6,344	148,078	160,766

(continued)

**Appendix I  
Statistical Methodology for Evaluating the  
Low-Income Housing Tax Credit Program**

Description	Estimate	Sampling error	Confidence interval	
			From	To
<b>Percentage of households</b>				
For households receiving subsidies and living in apartments where the total current monthly rent charged, including utility allowance and rental subsidy, is more than the maximum tax credit allowable rent (including utilities), as of April 1, 1996, the rental subsidy is				
Property based	43	15	29	58
Tenant based	15	9	6	24
Rural Housing Service	42	15	27	57
Total	100			
N=	15,114	4,298	10,816	19,413
For households receiving subsidies and living in apartments where the total current monthly rent charged, including utility allowance and rental subsidy, is more than 120 percent of the maximum tax credit allowable rent (including utilities), as of April 1, 1996, the rental subsidy is				
Property based	74	24	50	98
Tenant based	7	7	(0)	14
Rural Housing Service	19	24	(5)	43
Total	100			
N=	4,209	2,190	2,019	6,399
<b>Means for households</b>				
Number of people living in household				
Mean	2.15	0.08	2.07	2.23
N=	157,472			
Annual household income				
Mean	13,323	525	12,797	13,848
N=	156,116			
What is the average total current monthly rent charged, including utility allowance and rental subsidy, of low-income units by bedroom type?				
Efficiency				
Mean	342	40	302	382
N=	8,846			
1 bedroom				
Mean	385	15	370	400
N=	57,582			

(continued)

**Appendix I  
Statistical Methodology for Evaluating the  
Low-Income Housing Tax Credit Program**

Description	Estimate	Sampling error	Confidence interval	
			From	To
<b>Means for households</b>				
2 bedroom				
Mean	474	14	460	488
N=	61,487			
3 bedroom				
Mean	576	27	550	603
N=	26,338			
4 or more bedrooms				
Mean	623	64	560	687
N=	2,109			
Total (overall average)				
Mean	453	13	441	466
N=	157,079			

**Totals for households**

Annual rental subsidy amount in millions of dollars (12 times the difference between total current monthly rent, including utility allowance and rental subsidy, and the amount the tenant paid, when the tenant received a rent subsidy)

Total	229	28	201	257
N=	152,658			

Number of households receiving rent subsidies and living in apartments where the total current monthly rent charged, including utility allowance and rental subsidy, is more than the maximum tax credit allowable rent (including utilities), as of April 1, 1996, and the rental subsidy is

Property based	6,568	2,874	3,693	9,442
Tenant based	2,216	1,414	802	3,629
Rural Housing Service	6,331	3,075	3,256	9,406
N=	15,114	4,298	10,816	19,413

(continued)

**Appendix I  
Statistical Methodology for Evaluating the  
Low-Income Housing Tax Credit Program**

Description	Estimate	Sampling error	Confidence interval	
			From	To
<b>Ratios for households</b>				
Ratio of total current monthly rent charged, including utility allowance and rental subsidy, to monthly maximum tax credit allowable rent (including utilities), as of April 1, 1996.				
Efficiency	0.77	0.07	0.70	0.84
N=	8,739			
1 bedroom	0.86	0.03	0.83	0.89
N=	54,888			
2 bedrooms	0.85	0.02	0.83	0.87
N=	59,462			
3 bedrooms	0.87	0.04	0.83	0.92
N=	25,686			
4 or more bedrooms	0.84	0.08	0.76	0.93
N=	2,038			
Total	0.85	0.02	0.83	0.87
N=	150,813			

Note 1: Sampling errors and confidence intervals are calculated at the 95-percent level of confidence.

Note 2: Unless otherwise indicated, estimates represent approximately 158,975 + 6,160 occupied LIHTC apartments.

Note 3: "N=" indicates the number of households occupying LIHTC units included in the analysis.

Source: GAO's analysis of project and project manager questionnaires.

**Appendix I  
Statistical Methodology for Evaluating the  
Low-Income Housing Tax Credit Program**

**Table I.3: Sampling Errors for Table 2.1—Economic Data on Low-Income Households With and Without Additional Rental Assistance**

Households	Percentage of households	Average current income <sup>a</sup>	Average income as a percentage of the area's median income <sup>a</sup>
Receive additional rental assistance <sup>b</sup>	39 ± 4 N = 60,714	\$7,858 ± 346 N = 59,517	25 ± 1 N = 59,426
Do not receive additional rental assistance <sup>c</sup>	61 ± 4 N = 94,511	16,709 ± 525 N = 93,829	45 ± 1 N = 93,715
<b>Total</b>	<b>100</b> <b>N = 155,226 ± 6,256</b>	<b>\$13,323 ± 525</b> <b>N = 156,116<sup>d</sup></b>	<b>37 ± 1</b> <b>N = 155,827<sup>e</sup></b>

Note: The sampling errors of the estimates, at the 95-percent level of confidence, are provided following the "+." The number of households represented in the estimate is provided following the "N="." When information was available from all of our sampled respondents, the number of households was 158,975 ± 6,160.

<sup>a</sup>In our analyses, we used current incomes reported to us by property managers in 1996. HUD's definitions of low income, which apply to the housing credit program, are based on adjusted incomes (gross incomes less certain expenses). Consequently, our economic data will indicate that households are better off economically to the extent that the current incomes reported to us exceed the adjusted incomes.

<sup>b</sup>About 73 ± 6 percent of 60,714 ± 6,686 households with additional housing assistance also benefit indirectly from other government loans, loan subsidies, or grants.

<sup>c</sup>About 52 ± 6 percent of 94,511 ± 7,473 households without additional rental assistance benefit indirectly from other government loans, loan subsidies, or grants.

<sup>d</sup>Includes 2,770 households with missing rental assistance data.

<sup>e</sup>Includes 2,687 with missing data on rent subsidy.

Source: GAO's analysis of data from property managers.

**Appendix I  
Statistical Methodology for Evaluating the  
Low-Income Housing Tax Credit Program**

**Table I.4: Sampling Errors for Income Data on Low-Income Households by Type of Housing Assistance Provided**

<b>Type of assistance</b>	<b>Percent of households</b>	<b>Average current income</b>	<b>Average percent of median income</b>
Tax credit only	29 ± 4 N = 45,433	\$17,382 ± \$692 N = 44,963	47 ± 2 N = 44,887
Tax credit and other assistance to property only	32 ± 4 N = 49,079	\$16,089 ± \$766 N = 48,866	42 ± 1 N = 48,828
Tax credit, rental assistance, and other assistance to property	29 ± 4 N = 44,280	\$7,901 ± \$304 N = 43,134	27 ± 1 N = 43,115
Tax credit and rental assistance only	11 ± 2 N = 16,434	\$7,745 ± \$968 N = 16,383	22 ± 3 N = 16,311
<b>Total</b>	<b>100</b> <b>N = 155,226 ± 6,256</b>	<b>\$13,323 ± \$525</b> <b>N = 156,116<sup>a</sup></b>	<b>37 ± 1</b> <b>N = 155,827<sup>b</sup></b>

<sup>a</sup>Includes 2,770 households with missing rental assistance data.

<sup>b</sup>Includes 2,686 households with missing rental assistance data.

Source: GAO analysis of property manager questionnaire.



**Appendix I  
Statistical Methodology for Evaluating the  
Low-Income Housing Tax Credit Program**

**Table I.5: Sampling Errors for Table 2.1—Current Incomes by Type of Qualifying Household Reported by Property Managers in 1996 (Properties Placed in Service 1992 Through 1994)**

<b>Annual household gross income</b>	<b>All qualifying households</b>	<b>Households with additional rental assistance</b>	<b>Households with no additional rental assistance</b>
Less than \$5,000	10 $\pm$ 2 N = 15,178	22 $\pm$ 3 N = 12,857	2 $\pm$ 1 N = 2,321
\$5,000-\$9,999	29 $\pm$ 3 N = 44,506	54 $\pm$ 4 N = 32,175	13 $\pm$ 2 N = 12,331
\$10,000-\$14,499	23 $\pm$ 2 N = 35,954	17 $\pm$ 2 N = 10,217	27 $\pm$ 2 N = 25,738
\$15,000-\$19,999	20 $\pm$ 2 N = 31,095	5 $\pm$ 1 N = 3,093	30 $\pm$ 2 N = 28,002
More than \$20,000	17 $\pm$ 2 N = 26,613	2 $\pm$ 1 N = 1,176	27 $\pm$ 3 N = 25,437

Note: Columns may not add to 100 due to rounding.

Source: GAO analysis of data from low-income housing property managers.

**Table I.6: Sampling Errors for the Ratio of Household Current Income to Applicable Area Median Income by Type of Qualifying Household—Properties Placed in Service 1992-1994**

<b>Applicable area median income</b>	<b>All qualifying households</b>	<b>Households with additional rental assistance</b>	<b>Households with no additional rental assistance</b>
30 percent and under	38 $\pm$ 3 N = 59,019	68 $\pm$ 4 N = 41,115	19 $\pm$ 2 N = 17,904
31 to 50 percent	39 $\pm$ 2 N = 60,667	28 $\pm$ 3 N = 16,782	46 $\pm$ 2 N = 43,884
51 to 60 percent	17 $\pm$ 2 N = 25,881	4 $\pm$ 1 N = 2,231	25 $\pm$ 2 N = 23,651
61 and above	6 $\pm$ 1 N = 9,659	1 $\pm$ 0 N = 586	10 $\pm$ 1 N = 9,072

Note: Columns may not add to 100 due to rounding.

Source: GAO analysis of data from property managers.

**Appendix I**  
**Statistical Methodology for Evaluating the**  
**Low-Income Housing Tax Credit Program**

**Table I.7: Sampling Errors for Table 5.3—Types of Noncompliance Found by Desk Review and On-Site Inspections<sup>a</sup>**

Type of noncompliance	Desk reviews	On-site inspections
1. Tenant(s) not income eligible	30 + 18%	13 + 10%
2. Rents too high	12 + 12	7 + 7
3. Building code violation or other building condition		43 + 33
4. Administrative requirement not met <sup>b</sup>	35 + 23	10 + 9
5. Annual income certification either submitted late or not received	53 + 22	34 + 22
6. Improper income certification or failure to properly verify certifications	2 + 4	26 + 17
7. Other	16 + 14	7 + 6

<sup>a</sup>This analysis is limited to properties that were found to be in noncompliance at any time. It was further limited to properties that received only desk audits (37 sampled properties) or only on-site inspections (94 sampled properties)—about 8 and 18 percent of the properties, respectively. Since the number of sampled cases available for analysis was relatively small, the sampling errors of these estimates are relatively large.

<sup>b</sup>This category includes forms not filed on time, forms filed with incomplete information, or failure to meet other federal or administrative requirements.

Source: GAO analysis of sampled project questionnaires.

**Table I.8: Sampling Errors for Table 4.2—Sources of Financing for Projects Requiring Subsidies in Addition to Tax Credits**

Source of development financing	Percent
Grants/donations and concessionary loans	37 + 3
Tax credit equity	27 + 6
Commercial and other hard mortgages (payment required)	29 + 5
Other	06 + 3
<b>Total</b>	<b>100</b>

Note: An estimated 69 percent (+ 11 percent) of the properties received grants/donations and concessionary loans. However, this table is based on only the 84 percent (+ 13 percent) of the 69 percent of properties where reported sources and uses of funds did not differ by 5 percent or more—i.e., 58 percent (+ 11 percent) of all properties.

Source: GAO's analysis of project questionnaire.

---

# Additional Data on Incomes of Tax Credit Households by Type of Other Housing Assistance Received

---

The data in this appendix provide additional detail on the incomes of tax credit households presented in chapter 2. These data further demonstrate how direct rental assistance enables the tax credit program to serve those tax credit households with the lowest incomes.

As discussed in chapter 2, in 1996 an estimated 71 percent of the qualifying households in tax credit properties placed in service between 1992 and 1994 benefited directly or indirectly from one or more types of additional housing assistance. This assistance is provided either directly as rental assistance, or indirectly through loan subsidies or grants to property owners. Because such indirect assistance may reduce operating expenses or debt service costs, it can support lower rents. As table 2.1 indicated (see ch. 2), in 1996, the estimated average annual income of households in tax credit properties with additional rental assistance was \$7,858; the estimated average income of households without additional rental assistance was \$16,709.

However, many of the households—an estimated 73 percent—with additional rental assistance lived in units that also benefited indirectly from loan subsidies and grants. In addition, an estimated 52 percent of the households without rental assistance benefited indirectly from loan subsidies or grants. To isolate the impact of loan subsidies and grants on tax credit residents, we divided the households into four categories: (1) those with tax credit assistance only; (2) those with tax credit assistance and loan subsidies or grants; (3) those with tax credit and rental assistance; and (4) those with all three types of assistance—tax credit, rental, and loan subsidies or grants.

This analysis confirmed the significant role of direct rental assistance in serving households with the lowest incomes. Table II.1 shows that the average incomes of tax credit households with rental assistance were similar regardless of whether the property received loan subsidies or grants—an estimated \$8,000 in either case. The table also shows that when households were not receiving rental assistance, other assistance to tax credit properties—loan subsidies or grants—had only an incremental impact on the incomes of tax credit households.

**Appendix II  
Additional Data on Incomes of Tax Credit  
Households by Type of Other Housing  
Assistance Received**

**Table II.1: Income Estimates for Households Residing in Tax Credit Properties Placed in Service, 1992-94, by Type of Housing Assistance Provided**

<b>Type of assistance</b>	<b>Percent of households</b>	<b>Average current income</b>	<b>Average percent of median income</b>
Tax credits only	29	\$17,382	47
Tax credits and loan subsidies or grants	32	\$16,089	42
Tax credits and rental assistance	11	\$7,745	22
Tax credits, rental assistance, and loan subsidies or grants	29	\$7,901	27
<b>Total</b>	<b>100</b>	<b>\$13,323<sup>a</sup></b>	<b>37<sup>b</sup></b>

<sup>a</sup>Includes 2,770 households with missing rental assistance data.

<sup>b</sup>Includes 2,686 households with missing rental assistance data.

Source: GAO's analysis of data provided by tax credit property managers.

Tables II.2 and II.3 provide information on the incomes of households residing in tax credit properties that were placed in service between 1992 and 1994. The data, which are arrayed by the rental assistance status of the household, augment the information on incomes presented in figure 2.1 (see ch. 2). The data show that a large majority of tax credit households with rental assistance were at the lower end of the income distribution, whereas only a small proportion of tax credit households without rental assistance were at these low income levels. Table II.2 shows estimates for the income received by tax credit households, and table II.3 shows estimates for the incomes of tax credit households relative to the incomes of others in the same geographical area.

As noted in chapter 2, the small percentage of households whose incomes exceeded the tax credit program's limit of 60 percent of area median income does not necessarily indicate noncompliance with the income limits for two reasons. First, in our analyses, we used current incomes reported to us by tax credit property managers in 1996. HUD's definitions of low income, which apply to the tax credit program, are based on adjusted incomes (annual incomes less certain expenses). Consequently, our income data may place households in higher area median income categories to the extent that the current incomes reported to us exceed the adjusted incomes. Second, under the Internal Revenue Code, households whose incomes increased while they resided in tax credit units may remain in those units even if their incomes exceed the program's qualifying limits.

**Appendix II  
Additional Data on Incomes of Tax Credit  
Households by Type of Other Housing  
Assistance Received**

**Table II.2: Current Income Estimates by Type of Qualifying Household Reported by Property Managers in 1996 for Properties Placed in Service, 1992-94**

Annual household income	Percent of all qualifying households	Percent of households with additional rental assistance	Percent of households with no additional rental assistance
Less than \$5,000	10	22	2
\$5,000 - \$9,999	29	54	13
\$10,000 - \$14,499	23	17	27
\$15,000 - \$19,999	20	5	29
More than \$20,000	17	2	27

Note: Percentages may not add to 100 because of rounding.

Source: GAO's analysis of data provided by tax credit property managers.

**Table II.3: Ratio of Household Current Income Estimates to Applicable Area Median Income by Type of Qualifying Household for Properties Placed in Service, 1992-94**

Ratio of household income to area median income	Percent of all qualifying households	Percent of households with additional rental assistance	Percent of households with no additional rental assistance
30 percent and under	38	68	19
31 to 50 percent	39	28	46
51 to 60 percent	17	4	25
61 and above	6	1	10

Note: Percentages may not add to 100 because of rounding.

Source: GAO's analysis of data provided by tax credit property managers.

---

# Tax Credit Project Information Reported by Allocating Agencies and Used in the GAO Sample

---

The tables in this appendix present summary tax credit project universe and sample data. Universe data is the information we received from tax credit allocating agencies on tax credit projects placed in service from 1992 through 1994. Sample data identifies the information we used from sampling universe data.

Table III.1 shows that 52 tax credit allocating agencies located in 48 states and Washington, D.C., placed 4,221 projects in service between 1992 and 1994. We excluded tax credit project information for Alaska and Hawaii because we never intended to visit these locations to verify project-specific information. The 52 allocating agencies initially reported that they placed 4,225 tax credit projects in service during the subject period, but subsequent verification efforts disclosed that 4 of these projects contained redundant information.

Table III.2 presents the 431 tax credit projects that we sampled from the 4,225 projects initially reported by allocating agencies as placed in service between 1992 and 1994. Our original sample was 435 projects, but, again, 4 sample projects contained redundant information. Moreover, eight other sample projects had to be excluded from our analysis because we subsequently determined they either had not been placed in service during the subject period or their owners had never received an IRS Form 8609, which would have made them eligible to claim tax credits. As a result, the 435 tax credit projects and 48,725 tax credit-supported units contained in our original sample were ultimately reduced for review purposes to 423 tax credit projects containing 45,886 tax credit-supported units. These 423 sample tax credit projects represent an estimated population of 4,121 tax credit projects in our study universe.

**Appendix III  
Tax Credit Project Information Reported by  
Allocating Agencies and Used in the GAO  
Sample**

**Table III.1: Summary of Tax Credit  
Projects Reported to GAO by Tax  
Credit Allocating Agencies as Placed  
in Service During the Period 1992-1994**

<b>State</b>	<b>Total projects</b>	<b>Total units</b>	<b>Total LIHTC units</b>	<b>Total LIHTC award</b>
AK	0	0	0	\$0
AL	105	3,716	3,716	8,743,153
AR	70	3,737	3,733	9,826,063
AZ	34	2,386	2,211	9,114,966
CA	247	15,417	13,884	103,634,201
Chicago	30	2,325	2,306	8,771,563
CO	57	1,986	1,882	8,321,805
CT	25	962	806	6,060,180
DC	6	903	903	2,023,739
DE	15	788	783	2,838,575
FL	112	11,312	11,237	40,426,449
GA	104	5,110	4,881	9,458,009
HI	0	0	0	0
IA	90	2,933	2,927	7,299,461
ID	34	1,504	1,258	4,357,173
IL	125	3,661	3,504	10,077,651
IN	100	4,037	3,992	12,917,791
KS	43	2,224	2,224	4,387,379
KY	125	3,232	3,180	8,394,802
LA	81	3,559	3,471	6,880,774
MA	56	3,067	2,960	15,306,892
MD	73	5,951	4,936	15,688,562
ME	31	941	780	2,039,661
MI	167	7,860	7,007	22,608,020
MN	118	4,083	4,083	11,500,964
MO	221	4,368	4,124	12,065,205
MT	15	528	528	1,646,851
MS	80	3,490	3,470	3,532,221
NC	330	4,629	4,620	12,123,726
ND	30	668	668	1,805,829
NE	59	1,310	1,303	4,290,501
NH	12	296	292	680,178
NJ	69	4,196	3,957	21,660,341
NM	22	791	791	2,033,536
NV	13	701	701	3,279,838
NY	109	5,293	4,327	29,676,233
NYC	68	3,589	3,108	18,942,931

(continued)

**Appendix III  
Tax Credit Project Information Reported by  
Allocating Agencies and Used in the GAO  
Sample**

State	Total projects	Total units	Total LIHTC units	Total LIHTC award
NY(other)	8	824	639	1,516,850
OH	193	8,661	8,661	25,824,095
OK	54	2,157	2,015	2,817,924
OR	41	2,776	2,765	10,747,481
PA	190	5,024	4,878	25,808,479
RI	19	712	648	1,585,291
SC	81	2,598	2,598	5,142,650
SD	42	1,078	1,053	2,631,716
TN	76	2,106	2,106	6,307,471
TX	209	17,370	17,110	18,855,782
UT	46	1,850	1,760	5,871,045
VA	88	7,138	6,764	21,659,829
VT	23	463	421	1,428,283
WA	76	4,211	4,058	20,389,416
WI	154	4,908	4,422	15,278,902
WV	42	1,064	1,064	1,581,439
WY	3	78	78	169,483
<b>Total</b>	<b>4,221</b>	<b>184,571</b>	<b>175,593</b>	<b>\$610,031,359</b>

Source: GAO analysis of state-reported data.

**Table III.2: Summary of GAO Sample of Tax Credit Projects Reported to GAO by Tax Credit Allocating Agencies as Placed in Service During the Period 1992—1994**

State	Number of projects selected	Total units	LIHTC units	Total award (\$)
AK	0	0	0	0
AL	9	580	580	1,102,750
AR	9	866	866	2,656,762
AZ	6	864	864	3,836,820
CA <sup>b</sup>	34	3,702	3,526	25,327,649
Chicago	4	835	835	3,053,554
CO	5	349	345	1,353,127
CT	2	117	117	888,571
DC <sup>b</sup>	2	728	728	1,391,334
DE	2	211	210	767,639
FL	28	5,480	5,457	22,851,867
GA	12	1,174	1,161	2,318,473
HI	0	0	0	0
IA	7	440	434	1,001,549

(continued)



**Appendix III  
Tax Credit Project Information Reported by  
Allocating Agencies and Used in the GAO  
Sample**

State	Number of projects selected	Total units	LIHTC units	Total award (\$)
ID	3	161	144	436,543
IL	10	964	884	2,459,569
IN	10	752	752	2,024,089
KS	5	427	427	561,368
KY	8	495	460	1,221,270
LA	9	852	852	1,531,635
MA	7	1,082	1,048	3,500,349
MD	12	2,564	1,905	4,383,360
ME	2	98	70	144,281
MI	17	1,938	1,938	5,934,180
MN	10	784	784	1,905,029
MO	10	529	492	1,159,253
MS	9	1,129	1,114	787,320
MT	1	60	60	284,159
NC	11	458	457	1,282,690
ND	2	42	42	126,927
NE	3	102	102	400,596
NH	1	27	27	53,634
NJ <sup>a</sup>	9	1,907	1,899	5,949,373
NM	2	134	134	826,167
NV	1	60	60	273,749
NY	9	1,013	880	3,520,673
NYC	10	707	673	3,705,513
NY(other)	1	394	394	730,000
OH <sup>b</sup>	21	1,909	1,909	5,089,694
OK	5	394	368	465,512
OR	7	707	696	3,000,342
PA	12	651	541	4,101,084
RI	2	137	131	210,071
SC	6	540	540	790,251
SD	3	100	100	386,856
TN	5	512	512	1,062,144
TX <sup>a,b</sup>	42	7,776	7,776	7,214,387
UT	4	232	232	942,339
VA <sup>a</sup>	17	2,418	2,318	8,546,293
VT	2	55	47	92,815
WA	9	802	777	4,157,702
WI	11	573	488	1,818,957

(continued)

**Appendix III  
Tax Credit Project Information Reported by  
Allocating Agencies and Used in the GAO  
Sample**

<b>State</b>	<b>Number of projects selected</b>	<b>Total units</b>	<b>LIHTC units</b>	<b>Total award (\$)</b>
WV	3	88	88	139,003
WY	0	0	0	0
<b>Total</b>	<b>431</b>	<b>48,919</b>	<b>47,244</b>	<b>\$147,769,272</b>

<sup>a</sup>We excluded from our analysis one project in each of these states because project owners never received an IRS Form 8609.

<sup>b</sup>We excluded from our analysis one project in each of these states and two projects in the District of Columbia because these projects were never placed in service during our 1992-1994 review period.

Source: GAO analysis of state-reported data.

---

# Results of Site Visits to GAO Sample Properties

---

As part of our review, GAO evaluator teams from offices across the country visited 92 low-income housing tax credit projects in 37 states, New York City, Chicago, and Washington, D.C. As discussed in the Objectives, Scope and Methodology section of chapter 1, the projects were judgmentally selected, on the basis of cost considerations, from our stratified random sample of 423 projects. During the visits, the teams interviewed on-site management agents and project owners who frequently were on hand for our visits; generally reviewed tenant and project management records; walked through exterior grounds, residential units, and common areas; took photographs; and, for nearly all projects, reviewed the files of the five tenants who had most recently moved into the project. We reviewed each tenant file for evidence of (1) current annual household income; (2) income verification; (3) rent calculations, including utilities and allowances; and (4) tenant rent payments. Finally, we compared the total number of LIHTC units (according to bedroom size) reported by the on-site property manager with the number of units reported by the allocating agency in our project data collection instrument.

In the 431 tenant files we reviewed, we found almost no evidence of ineligible tenant incomes or excessive rent charges. In all but four tenant case files at four different properties, tenant data showed that property managers consistently adhered to program monitoring requirements by gathering and verifying household income data. Tenant file data also showed total rents charged for rental units and proportional tenant rent payments to be accurate. Further, the total number of units by bedroom size as reported by property managers and allocating agencies compared favorably.

The projects we visited had a wide variety of building types and floor plans in urban, suburban and rural settings. Many projects included the types of amenities found in market rate rental housing, such as swimming pools, laundry areas, covered parking garages, activity rooms, and playgrounds. What follows is a series of photographs and project descriptions that illustrate the diverse types of affordable housing we encountered in our review.

---

## Urban Projects

---

Castle Square, Boston,  
Massachusetts

Castle Square is a cluster of elevator high-rise buildings that were rehabilitated with several federal subsidies, including the low-income

---

**Appendix IV  
Results of Site Visits to GAO Sample  
Properties**

---

housing tax credit program. The property has a mix of 1-, 2-, 3-, and 4-bedroom family rental units. The average annual income of the typical 2-person household is about \$13,600, compared with an area median income of \$56,500. Monthly rents including utilities at Castle Square vary from \$814 for a 1-bedroom unit to \$1,359 for a 4-bedroom unit. However, the average monthly rent paid by resident households is about \$300 because all low-income rental units have section 8 project-based rental assistance attached to them. Castle Square had an average occupancy rate of 99 percent during 1995.

Tax Credit Award	9 percent
Total Residential Units	500
Total Low-Income Units	470
Total Development Cost	\$52.7 million
Average Cost Per Unit	\$105,400

---

**Figure IV.1: Castle Square, Boston, MA**



---

**Turk Street Apartments,  
San Francisco, California**

The Turk Street Apartments is an elevator high-rise property that was newly constructed without the use of federal subsidies other than the low-income housing tax credit program. The property has a mix of efficiencies and 1-, 2-, and 3-bedroom family rental units. The average annual income of the typical 2-person household is about \$16,300, compared with an area median income of \$61,300. Monthly rents including utilities at Turk Street vary from \$483 for an efficiency unit to \$657 for a 3-bedroom unit. Although most low-income residents in this property pay unsubsidized rents, households with rental assistance pay as little as \$155 for an efficiency and \$218 for a 2-bedroom apartment. Turk Street was fully occupied during 1995.

Tax Credit Award	9 percent
Total Residential Units	175
Total Low-Income Units	175
Total Development Cost	\$35.3 million
Average Cost Per Unit	\$201,700

---

**Figure IV.2: Turk Street Apartments,  
San Francisco, CA**



---

**Appendix IV  
Results of Site Visits to GAO Sample  
Properties**

---

**Mount Mercy, Grand  
Rapids, Michigan**

Mount Mercy is a 1-bedroom rental unit property for elderly residents. A former Catholic girls school, this property contains one elevator high-rise building that was purchased and rehabilitated without the use of federal subsidies other than the low-income housing tax credit program. The average annual income of the typical resident 1-person household is about \$12,400, compared with an area median income of \$45,100. Monthly rents are \$295 including utilities, and no resident receives rental assistance. Mount Mercy had a 98 percent occupancy rate during 1995.

Tax Credit Award	4 percent and 9 percent
Total Residential Units	125
Total Low-Income Units	125
Total Development Cost	\$6.1 million
Average Cost Per Unit	\$48,800

---

**Figure IV.3: Mount Mercy, Grand  
Rapids, MI**



**Graham/Terry, Seattle,  
Washington**

Graham/Terry is an elevator high-rise property that contains both newly constructed and rehabilitated buildings that were developed without federal subsidies other than the low-income housing tax credit program. The buildings are nearly 75 percent efficiency units, and the average annual income of the typical single-resident household is about \$10,700, compared with an area median income of \$52,800. Monthly rent for an efficiency unit is \$280 including utilities, and all but a few residents (less than 10) pay full rent without benefit of rental assistance. Graham/Terry had a 95 percent occupancy rate during 1995.

Tax Credit Award	4 percent and 9 percent
Total Residential Units	121
Total Low-Income Units	121
Total Development Cost	\$7.6 million
Average Cost Per Unit	\$62,800

**Figure IV.4: Graham/Terry, Seattle WA**



---

**Appendix IV  
Results of Site Visits to GAO Sample  
Properties**

---

**Providence Square, New Brunswick, New Jersey**

Providence Square is a 1-bedroom rental unit property for elderly residents. A former cigar factory, this property comprises one elevator high-rise building that was rehabilitated without the use of federal subsidies other than the low-income housing tax credit program. The average annual income of the typical resident 1-person household is about \$16,200, compared with an area median income of \$67,400. Average monthly rents are \$438 including utilities, and no household receives rental assistance. Providence Square was fully occupied during 1995.

Tax Credit Award	9 percent
Total Residential Units	99
Total Low-Income Units	99
Total Development Cost	\$11.1 million
Average Cost Per Unit	\$112,100

---

**Figure IV.5: Providence Square, New Brunswick, NJ**





**O’hern House, Atlanta,  
Georgia**

O’hern House is a home for troubled and homeless residents. A former shoe factory, this property contains only efficiency rental units in a 4-story elevator high-rise building that was gutted and completely renovated using historic preservation and low-income housing tax credit program subsidies. The average annual income of the single resident population is about \$4,283, compared with an area median income of \$52,100. Monthly rent is about \$150 including utilities. The rent level is set at 30 percent of a resident’s monthly income, which typically comes from supplemental (SSI) and disability (SSDI) Social Security income sources. No resident receives state or federal rental assistance. As a special needs project, O’hern House contains many amenities and services, such as (1) a cafeteria that provides three meals a day at no charge, (2) maid service at no charge 2 days a week, (3) full building security, (4) laundry facilities and recreation rooms on every floor, (5) an in-house newsletter and tenant association, and (6) psychological and medical professionals available to residents who are mentally challenged and previously homeless. These features are provided in part through a \$1.3 million annual operating subsidy from the Georgia Department of Human Resources. O’hern House had a 97 percent occupancy rate during 1995.

Tax Credit Award	9 percent
Total Residential Units	76
Total Low-Income Units	76
Total Development Cost	\$2.9 million
Average Cost Per Unit	\$38,200

**Figure IV.6: O’hern House, Atlanta, GA**



---

## Suburban Projects

---

### Cascade Commons, Sterling, Virginia

Cascade Commons is composed of multiple garden-style, walk-up buildings for family residents in 2- and 3-bedroom units. It was newly constructed without federal subsidies other than the low-income housing tax credit program. About 75 percent of the units are 2-bedroom apartments where the average 2-person household has an annual income of nearly \$27,000, compared to an area median income of \$68,300. Average monthly rent and all utility charges for a 2-bedroom unit at Cascade Commons amount to about \$835, and no household receives rental assistance. Although this property reported a 43 percent average vacancy rate in 1995, it currently has a 93 percent occupancy rate, and it reported achieving a 90 percent occupancy rate within 3 months of being placed in service.

Tax Credit Award	9 percent
Total Residential Units	320
Total Low-Income Units	320
Total Development Cost	\$28.6 million
Average Cost Per Unit	\$89,400

---

**Appendix IV**  
**Results of Site Visits to GAO Sample**  
**Properties**

---

**Figure IV.7: Cascade Commons,  
Sterling, VA**



**Rancho Del Mar, Tucson,  
Arizona**

Rancho Del Mar is a 1- and 2-bedroom unit rental property for family residents. It is made up of multiple garden-style buildings, newly constructed without the use of federal subsidies from other than the low-income housing credit program. The average annual income of the typical resident 2-person household is \$12,300; \$14,600 for the typical resident 3-person household, compared to an area median income of \$37,800. Average monthly rents including utilities at Rancho Del Mar vary from \$390 for a 1-bedroom unit to \$452 for a 2-bedroom unit. Although most low-income residents in this property pay unsubsidized rents, households with rental assistance pay an average of \$26 a month for a 1-bedroom unit and \$55 a month for a 2-bedroom unit. Rancho Del Mar had a 94 percent occupancy rate during 1995.

Tax Credit Award	9 percent
Total Residential Units	312
Total Low-Income Units	312
Total Development Cost	\$8.8 million
Average Cost Per Unit	\$28,200

**Figure IV.8: Rancho Del Mar, Tucson,  
AZ**



---

**Appendix IV  
Results of Site Visits to GAO Sample  
Properties**

---

**Covington Court, St. Paul,  
Minnesota**

Covington Court is a family rental property. It is made up of multiple 3-story mid-rise buildings that were rehabilitated with federal subsidies. The property has a mix of 1- and 2-bedroom units but is predominantly 1-bedroom. The average annual income of the typical 1-person household living in a 1-bedroom unit is \$14,100, compared to an area median income of \$54,600. Monthly rent including utilities for a 1-bedroom unit is \$434. About one-third of the households occupying 1-bedroom units receive rental assistance and pay, on average, only \$123 a month for rent. Covington Court had a 98 percent occupancy rate during 1995.

Tax Credit Award	4 percent
Total Residential Units	160
Total Low-Income Units	160
Total Development Cost	\$3.6 million
Average Cost Per Unit	\$22,500

---

**Figure IV.9: Covington Court, St. Paul,  
MN**



---

**Lakewood Terrace,  
Lakeland, Florida**

Lakewood Terrace is a collection of garden-style 2-story buildings containing rental units for family residents. These buildings were purchased and rehabilitated with federal subsidies, including the low-income housing tax credit program. Mostly 2- and 3-bedroom units, Lakewood Terrace also offers some 1-bedroom and 4-bedroom units. The average annual income of the typical 4-person household occupying a 3-bedroom unit is \$6,372, compared with an area median income of \$35,900. Average monthly rent including utilities for the 3-bedroom unit is \$429. However, since all rental units in this property have section 8 project-based assistance attached to them, the average rent paid by a low-income family in a 3-bedroom unit, for example, is about \$77 a month. Lakewood Terrace had a 95 percent occupancy rate during 1995.

Tax Credit Award	4 percent
Total Residential Units	132
Total Low-Income Units	132
Total Development Cost	\$7.2 million
Average Cost Per Unit	\$54,500

---

**Figure IV.10: Lakewood Terrace,  
Lakeland, FL**



---

**Appendix IV  
Results of Site Visits to GAO Sample  
Properties**

---

**Mansfield Manor,  
Mansfield, Texas**

Mansfield Manor is a rental property for special needs elderly and disabled residents. It is made up of 1- and 2-bedroom townhouses that were newly constructed using multiple federal subsidies. About half of its units are 2-bedroom apartments in which the average 2.3-person household has an average annual income of \$9,211, compared to an area median income of \$47,500. Monthly rent including utilities for these units is \$284, but most resident households have rental assistance and pay, on average, \$81 a month in rent. Mansfield Manor was fully occupied in 1995.

Tax Credit Award	4 percent
Total Residential Units	52
Total Low-Income Units	52
Total Development Cost	\$2.1 million
Average Cost Per Unit	\$40,400

---

**Figure IV.11: Mansfield Manor,  
Mansfield, TX**



---

## Rural Projects

---

### Lake Pointe, Conway, Arkansas

The Lake Pointe Apartments contain 1- and 2-bedroom rental units for family residents. This walk-up, garden-style building community was newly constructed without the use of federal subsidies other than the low-income housing tax credit. The average annual income of the typical 2-person household living in a 2-bedroom unit is about \$14,210, compared with an area median income of \$39,000. Average monthly rent including utilities for these 2-bedroom units is \$375, and no households receive rental assistance. Lake Pointe had a 98 percent occupancy rate during 1995.

Tax Credit Award	9 percent
Total Residential Units	132
Total Low-Income Units	132
Total Development Cost	\$5.1 million
Average Cost Per Unit	\$38,600

---

Figure IV.12: Lake Pointe, Conway, AR





---

**Appendix IV  
Results of Site Visits to GAO Sample  
Properties**

---

**Post Glen, Oceana, West  
Virginia**

Post Glen is a 1- and 2-bedroom elevator mid-rise building for elderly residents. It was newly constructed using federal subsidies, including the low-income housing tax credit program. The average annual income of the typical single-resident household is about \$5,788, compared with an area median income of \$24,400. Monthly rent including utilities is \$355, but almost all households receive rental assistance and pay, on average, only \$94 of this monthly rent amount. Post Glen was 70-percent occupied in 1995.

Tax Credit Award	4 percent
Total Residential Units	41
Total Low-Income Units	40
Total Development Cost	\$1.8 million
Average Cost Per Unit	\$43,700

---

**Figure IV.13: Post Glen, Oceana, WV**



---

**Appendix IV**  
**Results of Site Visits to GAO Sample**  
**Properties**

---

**Edgewood Apartments,  
Belton, South Carolina**

Edgewood Apartments is a garden-style, walk-up community for family residents. Its predominantly 2-bedroom rental unit buildings were rehabilitated without using federal subsidies, other than the low-income housing tax credit program. The average annual income of the typical 2-person household is \$10,675, compared to an area median income of \$40,300. Monthly rent including utilities is \$322. Only a few families receive rental assistance, and these households pay, on average, about \$54 in rent. About half of Edgewood's rental units were vacant during 1995.

Tax Credit Award	9 percent
Total Residential Units	32
Total Low-Income Units	32
Total Development Cost	\$735,000
Average Cost Per Unit	\$23,000

---

**Figure IV.14: Edgewood, Belton, SC**



---

**Appendix IV  
Results of Site Visits to GAO Sample  
Properties**

---

**Hardwick, Hardwick,  
Vermont**

Hardwick contains seven units of family rental housing in one garden-style walk-up building. It was newly constructed with federal subsidies, including the low-income housing tax credit program. Six of the seven rental units are 2-bedroom apartments, in which the typical household contains two people whose average annual income is less than the average of the other 2-bedroom, 2-person households in this appendix and less than half of the area median income where this property is located. Monthly rent including utilities for these 2-bedroom units is \$386, but half of the six households receive rental assistance and pay, on average, only \$160 in rent. Hardwick had an 86 percent occupancy rate (one vacancy) during 1995.

Tax Credit Award	4 percent
Total Residential Units	7
Total Low-Income Units	7
Total Development Cost	\$950,000
Average Cost Per Unit	\$135,500

---

**Figure IV.15: Hardwick, Hardwick VT**



# Comments From the Internal Revenue Service



COMPLIANCE OFFICER

DEPARTMENT OF THE TREASURY  
INTERNAL REVENUE SERVICE  
WASHINGTON, D.C. 20224

March 14, 1997

Mr. James R. White  
Associate Director  
Tax Policy and Administration Issues  
United States General Accounting Office  
Washington, DC 20548

Dear Mr. White:

We have received your draft report entitled: Tax Credits: Opportunities to Improve Oversight of the Low-Income Housing Program, and commend GAO on its thorough and comprehensive study of the Low-Income Housing Program.

In your report, you make a recommendation to the Director, Office of Management and Budget, to incorporate the Low-Income Housing Tax Credit Program under the Single Audit Act. We are not familiar with the intricacies of the Single Audit Act and, therefore, express no opinion on its suitability for this program.

At the closing conference, we communicated to your staff several comments that do not substantively change the content of the report.

If the GAO report is finalized as drafted, including the recommendations for modifications of the low-income housing regulations, we will be pleased to work with the Office of Chief Counsel and the Treasury Department to determine how to best implement GAO's recommendations.

Sincerely,

A handwritten signature in cursive script, appearing to read "James E. Donelson".

James E. Donelson  
Acting Chief Compliance Officer

# Comments From the National Council of State Housing Agencies



March 14, 1997

Mr. James R. White  
Associate Director  
Tax Policy and Administration Issues  
U.S. General Accounting Office  
441 G Street, NW  
Suite 1-T-47  
Washington, DC 20548

Dear Jim:

As national representative of all the state agencies which administer the Low Income Housing Tax Credit (Housing Credit), the National Council of State Housing Agencies (NCSHA) appreciates the opportunity to comment on the General Accounting Office's (GAO) report: *Tax Credits: Opportunities to Improve Oversight of the Low Income Housing Program*. We respect the major effort GAO made in this study and are grateful for the opportunity to help GAO throughout the study.

We have previously expressed concern, however, about potential bias and prejudice in some aspects of GAO's work in preparing that Report. The Report itself, on which you have asked this comment, answers many, though not all, those concerns. It vindicates public predictions by GAO officials that nothing in the Report could justify Housing Credit repeal. Instead, it documents that the Housing Credit is exceeding the important objectives Congress set for it, addressing low income rental needs in urban, suburban, and rural areas all across the country. For example:

- Though the law allows Housing Credit apartment renters to have up to 60 percent of the area median income (AMI), the 1996 average is under 40 percent; and more than three out of four renters have incomes under 50 percent.
- Housing Credit apartment rents are well below market rents, up to 23 percent less than the maximum permitted, and 25 percent below HUD's national Fair Market Rent.
- States are giving preference to apartments serving low income tenants longer than the fifteen years the law requires; in fact two-thirds of the apartments GAO studied were set aside for 30 years or more.

444 North Capitol Street, NW, Suite 438 Washington, DC 20001 (202)624-7710 FAX (202)624-5899

---

**Appendix VI  
Comments From the National Council of  
State Housing Agencies**

---

- Housing Credit properties are well maintained and overwhelmingly comply with statutory and regulatory requirements, with almost no ineligible tenant incomes or excessive rent charges.
- Though IRS regulations do not require it, states had conducted on-site visits to 75 percent of all Housing Credit properties by June, 1996 and provide compliance manuals or training or both to project owners and managers.
- Housing Credit apartment development costs are reasonable, averaging less than \$60,000 a unit. Though federal law does not require it, states typically limit developer and builder fees and use competition to control costs.
- Each Housing Credit dollar now generates 25 percent more apartment investment than before Congress made the program permanent in 1993.

Our concerns about bias and prejudice in the Report center on two recurrent aspects of its findings regarding state Housing Credit administration:

- its implication of deficiency if a state chooses a Housing Credit administration method consistent with existing federal law, but different from a "best practice" NCSHA has recommended that its members consider.
- its omission of corrective action, where it has occurred, in the cases where the Report criticizes some aspect of a few states' Housing Credit administration.

The Report comments favorably and extensively on the "best practice" standards which the state Housing Credit agencies themselves developed through NCSHA for each state to adapt to its own unique circumstances. These "best practices" deal with some aspects of underwriting, development costs, and compliance monitoring. Though they have been adopted in whole or part by most states, they were never intended to suggest that some other practice might not be "good" or even "better" for a particular state, based on its unique circumstances, as long as it is fully consistent with existing federal law.

The Report recognizes the major strength Congress built into the Housing Credit when it avoided prescribing traditional, "one size fits all" national solutions, since each state has unique housing needs, market conditions, and development costs. Instead, Congress encouraged state variety appropriate to local housing needs. We cautioned GAO frequently during our extensive cooperation with its study that NCSHA's "best practices" are all higher standards than actual law requires. We strongly suggested that it would be unfair to imply a deficiency simply because a state, upon consideration, chose not to follow some of NCSHA's recommendations.

---

**Appendix VI**  
**Comments From the National Council of**  
**State Housing Agencies**

The Report, however, implies precisely such judgments in some places, as where it notes that "some of the agencies that did on-site inspections fell short of meeting minimum on-site monitoring reviews recommended by NCSHA," even though the Housing Credit law does not require it.

We repeat our frequent caution that individual and collective state performance can only be fairly judged against the actual requirements of existing federal law, not against standards which exceed those requirements and may not be appropriate in all cases. And we strongly suggest that the Report expressly acknowledge cases where a state has taken action to remedy the few deficiencies in administration the Report cites, which we understand, for example, to be the case in both Texas and New York.

We have also previously called GAO's attention to its arbitrary inclusion in its study sample of all the developments with 300 or more apartments placed in service during the study period. We note that the Report's Appendix includes a disproportionate number of these largest developments, but does not advise the reader of that weighting. For example, GAO found the average Housing Credit development has 43 apartments. The developments described in the Appendix average 160 apartments each. Half the developments in the Appendix are elevator/high-rise type, which GAO found to be the highest cost building type. But that building type represents only 10 percent of the developments GAO actually studied.

We are also concerned that some of the Report's recommendations do not take account of their cost-effectiveness. It recommends, for example, that the Service amend Housing Credit regulations to require independent verification of key information of sources and uses of funds submitted by developers that form the basis of state decisions about the amount of Housing Credits to allocate. While this is consistent with NCSHA's "best practice," its imposition by all states on all properties could have significant cost implications, particularly for smaller developers.

The Report also recommends that the Service require states to report sufficient information about monitoring inspections, including their number and type, to assure that states have complied with their monitoring plans. Such a requirement should be limited to information that is both pertinent and useful. The voluminous reporting of noncompliance IRS Form 8823 currently requires, for example, makes clear that reporting for its own sake is not helpful and can actually obstruct the Service's monitoring efforts.

The Report suggests that the Service explore ways to obtain "better" information to verify that states' allocations do not exceed Housing Credit authorizations and to evaluate taxpayer and housing project compliance with the law. However, the Report offers little evidence of Credit overallocation or property or owner noncompliance.

**Appendix VI  
Comments From the National Council of  
State Housing Agencies**

The Report recommends that OMB include the Housing Credit program under the Single Audit Act, but does not discuss whether such audits need adaptation to the Housing Credit. For example, such audits should be structured in a way which confirms state agency compliance with the procedures Congress has mandated. They should not frustrate congressional intent that the Housing Credit be responsive to actual local housing conditions and not interfere with the appropriate exercise of state judgment by encouraging bureaucratic second guessing of outcomes determined as Congress meant them to be.

Finally, we need to emphasize that the terms of confidentiality GAO asked us to observe regarding the draft Report and this comment precluded most fact checking regarding the accuracy of statements in the Report regarding any state or development.

We appreciate the opportunity to help the GAO in its work on this Report and to offer these comments on it. We have pledged to Congress and the Service throughout the history of the Housing Credit that the states are ready to help them write and implement any improvement they deem necessary to improve the Housing Credit. The Report notes that NCSHA has created a special Housing Credit Commission, reflective of all the responsible participants in the Housing Credit community, to be available to Congress and the Service in any such effort.

Particularly in light of the strong bill of health this Report actually gives the Housing Credit, however, any changes should be made only with considerable cause, deliberation, and caution. In President Reagan's words, "If it ain't broke, don't fix it." We believe that, on balance, that is the real message in this Report.

Sincerely,

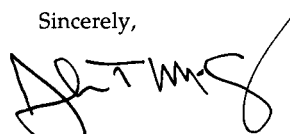

John T. McEvoy  
Executive Director



---

# Major Contributors to This Report

---

## General Government Division, Washington, D.C.

Ralph T. Block, Assistant Director, Tax Policy and Administration Issues  
Thomas M. Richards, Senior Evaluator

---

## Resources, Community, and Economic Development Division, Washington, D.C.

Dennis W. Fricke, Assistant Director, Housing and Community  
Development Issues  
William F. Bley, Senior Evaluator  
Andrew E. Finkel, Senior Evaluator  
Diane T. Brooks, Senior Evaluator

---

## San Francisco Office

George A. Zika, Evaluator-in-Charge  
Kathleen E. Seymour, Senior Evaluator  
Arthur L. Davis, Senior Evaluator  
Mary L. Jankowski, Evaluator  
Sharon K. Caporale, Evaluator  
Susan S. Mak, Evaluator

---

## Technical Support

Karen E. Bracey, Assistant Director, Design, Methodological, and  
Technical Group  
Patrick B. Doerning, Senior Operations Research Analyst  
Luann M. Moy, Senior Social Science Analyst  
Elizabeth R. Eisenstadt, Communication Analyst  
Samuel H. Scrutchins, Technical Advisor  
Donna M. Leiss, Communications Analyst

---

## Survey Team Members

Joanna M. Stamatiades, Senior Evaluator-Atlanta Office  
Salley P. Gilley, Evaluator-Atlanta Office  
Nancy S. Barry, Senior Evaluator-Boston Office  
Frank M. Taliaferro, Senior Evaluator-Chicago Office  
Marvin G. McGill, Evaluator-Kansas City Office  
Margarita A. Vallazzo, Evaluator-Kansas City Office  
Jennie B. Davis, Senior Evaluator-Dallas Office  
Willie D. Watson, Senior Evaluator-Dallas Office

---

## Ordering Information

The first copy of each GAO report and testimony is free. Additional copies are \$2 each. Orders should be sent to the following address, accompanied by a check or money order made out to the Superintendent of Documents, when necessary. VISA and MasterCard credit cards are accepted, also. Orders for 100 or more copies to be mailed to a single address are discounted 25 percent.

### Orders by mail:

U.S. General Accounting Office  
P.O. Box 6015  
Gaithersburg, MD 20884-6015

### or visit:

Room 1100  
700 4th St. NW (corner of 4th and G Sts. NW)  
U.S. General Accounting Office  
Washington, DC

Orders may also be placed by calling (202) 512-6000 or by using fax number (301) 258-4066, or TDD (301) 413-0006.

Each day, GAO issues a list of newly available reports and testimony. To receive facsimile copies of the daily list or any list from the past 30 days, please call (202) 512-6000 using a touchtone phone. A recorded menu will provide information on how to obtain these lists.

For information on how to access GAO reports on the INTERNET, send an e-mail message with "info" in the body to:

[info@www.gao.gov](mailto:info@www.gao.gov)

or visit GAO's World Wide Web Home Page at:

<http://www.gao.gov>

---

**United States  
General Accounting Office  
Washington, D.C. 20548-0001**

**Bulk Rate  
Postage & Fees Paid  
GAO  
Permit No. G100**

**Official Business  
Penalty for Private Use \$300**

**Address Correction Requested**

---

